

OPERATORS MANUAL

GP-3000

GRAPHICS PROJECTOR

 **GraphicSmart**[™]
WITH DIGITAL CONVERGENCE[™]

PART I

CONNECTIONS AND LAYOUT OF CONTROLS

CONTENTS

• INTRODUCTION	4
Important Safeguards	4
Specifications	6
• PART I: CONNECTIONS AND LAYOUT OF CONTROLS	
1. Connection Example	10
2. Projector: Control Position and Functions	12
3. Functions of Remote Controls	14
4. DIP SWITCH FUNCTIONS	18
DIP switch 1	18
DIP switch 2	20
5. REMOTE 1 Terminal	22
• PART II: INSTALLATION	
1. Installation Procedure	24
2. Ceiling Installation	26
3. Installation Method Change	28
DIP Switch 2 Setting	28
Polarity Change	29
4. Screen Size Change	31
Changing the Position of Decorative Boards	31
5. Spacer Installation	32
6. Adjusting the Angle of CRTs	34
• PART III: SET UP/REMOTE CONTROL OPERATION/CONVERGENCE	
1. Operation Procedure	36
2. Adjusting the Centering Magnets	38
3. Lens Focus Adjustment	39
4. Electrical Focus Adjustment	40
5. Alignment Adjustment	41
6. Convergence Adjustment	42
7. Convergence Cancel Function	46
8. Convergence Data Copy	48
9. Picture Adjustment	49
• PART IV: INPUT SIGNAL RECORDING/CHANGING RGB INPUT SIGNAL	
1. Input Signal Entry Mode Method	52
Input List Mode	52
Explanation of Screen Format	53
Selection and Cancellation of the Recording Line	54
Recording of Scan Number	55
Recording of the Input Signal Terminal	56
Recording of the User Source Name	57
Recording of Combinations	58
Completion of the Signal Recording	59
Input Signal Recording at the Time of Factory Shipment	60
2. Changing the RGB Input Signal	61
• PART V: CHARTS/REFERENCE TABLES/TROUBLESHOOTING	
1. Timing Charts	64
2. Troubleshooting	66
LIMITED WARRANTY	

SPECIFICATIONS

Video Projector

- | | | | | | |
|---------------------------|--|-----|-------|------|-----|
| 1. Projection type | : Refraction type
Projector and screen are separated. | | | | |
| 2. Projection system | : 3 lens and 3 CRT's in-line | | | | |
| 3. Lens | : Hybrid lenses multilayer coating
F: 1.0 | | | | |
| 4. CRT | : Improved 7 inch liquid cooling | | | | |
| 5. High voltage | : 34 kV | | | | |
| 6. Light output | : 600 lumens
(Small area peak high light brightness) | | | | |
| 7. Contrast ratio | : 20 (HDTV method)
50 (JIS method) | | | | |
| 8. Resolution | : CENTER

<table border="0" style="margin-left: 40px;"> <tr> <td style="text-align: center;">RGB</td> <td style="text-align: center;">VIDEO</td> </tr> <tr> <td style="text-align: center;">1000</td> <td style="text-align: center;">600</td> </tr> </table> | RGB | VIDEO | 1000 | 600 |
| RGB | VIDEO | | | | |
| 1000 | 600 | | | | |
| 9. Pixel resolution | : 1024 × 768 dots | | | | |
| 10. Picture size | : 60-300" diagonal | | | | |
| 11. Convergence | : Digital convergence (Presetable 12 positions) | | | | |
| 12. Convergence limits | : less than 0.2% of V-height | | | | |
| 13. Warm up time | : 10 min | | | | |
| 14. Set-up signal | : Cross hatch, dot (Coarse & fine) | | | | |
| 15. Input | : RGB signal 0.7 Vp-p 75Ω Positive (BNC)
H.V sync 0.7-4.0 Vp-p 75Ω
Negative or Positive (BNC)
G.sync 0.3-0.6 Vp-p 75Ω Negative
NTSC VIDEO 1.0 Vp-p 75Ω Positive
(Switchable)
NTSC S-VIDEO Y 1.0 Vp-p 75Ω Positive
C 0.28 Vp-p 75Ω (Burst level) | | | | |
| 16. Scanning frequency | : H 15-55 kHz
V 38-100 Hz | | | | |
| 17. Retrace time | : H 4.5 μS min.
V 450 μS min. | | | | |
| 18. Sweep reversal | : Available (Serviceman adjustment) | | | | |
| 19. Power supply | : AC 120V 60 Hz (100-132V) | | | | |
| 20. Power consumption | : 330W | | | | |
| 21. Safety and regulatory | : Meet UL 478
FCC : Meet FCC Class A
DHHS : Meet | | | | |
| 22. Cabinet dimensions | : 610 (W) × 754 (D) × 310 (H) mm
24 (W) × 29-11/16 (D) × 12-1/4 (H) inches | | | | |
| 23. Weight | : 60kg, 132 lbs | | | | |
| 24. Remote control | : Wired application
Wireless (Operating distance 7m, 23ft.) | | | | |

Specifications are subject to change without notice.

- 25. Remote control function** : Power ON/OFF
Picture mute
Input signal select
Test signal select
On screen display ON/OFF
Picture function control
Brightness, Contrast, Color, Tint, Sharpness
R.G.B.-Gain (With System Interface)
V-height
H-width
H-position
V-hold
Convergence control
Static, Dynamic, Point
Focus control
Center, Edge, H/V Balance
- 26. Main control function** : Picture function control
Brightness, Contrast, Color, Tint, Sharpness
Alignment function control
V-height, H-width, H-position, V-hold
- 27. Remote control hand unit** : User remote control UR-3020
Set-up remote control IR-3040
- 28. Supplied accessories** : User remote control
Set-up remote control
Remote cable 4m, 13 ft
Remote cable 16m, 52 ft
AC line cable
Ceiling mounting kit
Operators manual
Picture Size Spacers
- 29. External control** : Power ON/OFF
Input signal select
Picture mute
- 30. Environmental**
Temperature : 0 to 40 degrees C
Humidity : 0 to 90% non-condensing
Storage : -10 to 50 degrees C

The diagram below shows examples of connections to the projector when the System Interface is not used.

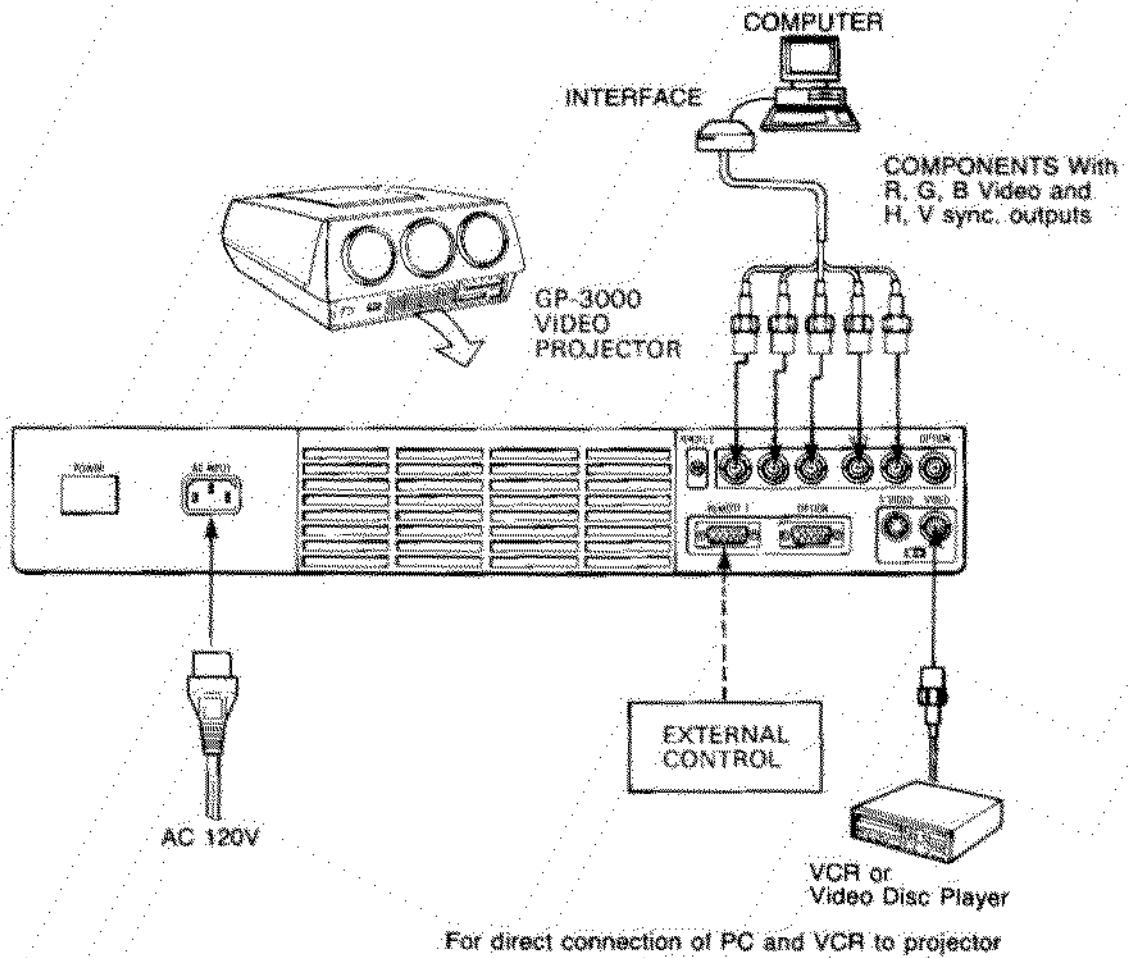

2. PROJECTOR: CONTROL POSITION AND FUNCTIONS

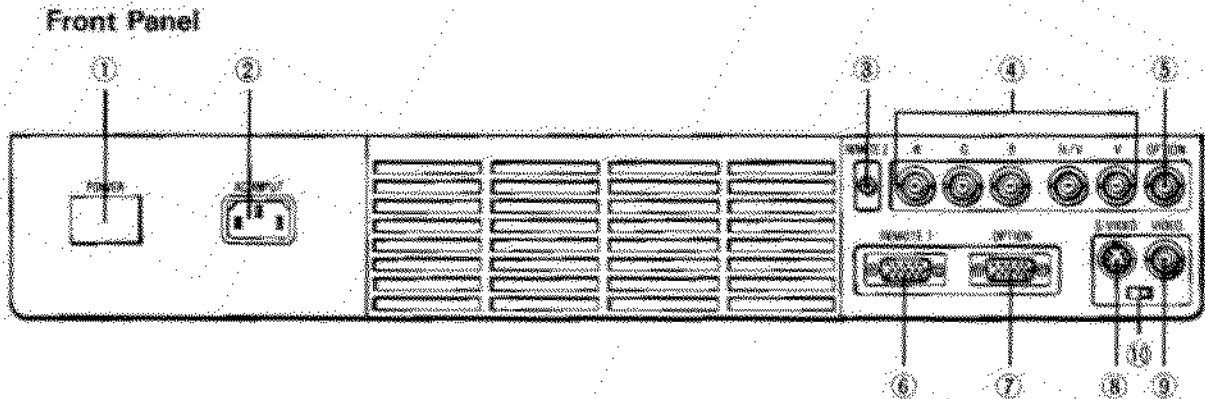

- ① **POWER Button**..... This main power switch supplies 120V AC power to the projector.
- ② **AC INPUT** Connect the supplied power cord here.
- ③ **REMOTE 2 Jack**..... When the supplied remote control is used in the wired condition, connect the supplied remote cable here.
- ④ **R, G, B, H/V, V Input Terminal (BNC type)**..... When the System Interface (SI-5320) is used, the 5 set coaxial cable attached to the System Interface R, G, B, H and V output is connected to these input terminals on the projector. Also, when the projector is used alone (no System Interface) the RGB output from a computer can be connected to these input terminals. If using a component with a combined Horizontal and Vertical sync output, connect it to the H/V terminal.
- ⑤ **OPTION Input Terminal (BNC type)** This is a terminal for future system expansion.
- ⑥ **REMOTE 1 Terminal**..... This connector allows external control of the projector from either the System Interface (SI-5320) or from an external control device. When the System Interface is used, it is connected to the REMOTE 1 terminal on the back of the System Interface.
- ⑦ **OPTION Input Terminal**..... This is a terminal for future system expansion.
- ⑧ **S-VIDEO Input Terminal**..... When the projector is used alone, video equipment with a S-Video output can be connected to this terminal.
- ⑨ **VIDEO Input Terminal (BNC type)** When the projector is used alone, video equipment such as a VCR, VDP, camera, etc. can be connected to this terminal.
- ⑩ **S-VIDEO/VIDEO Select Switch**.... This switch selects either the S-Video input or the Video input terminal.

REAR PANEL

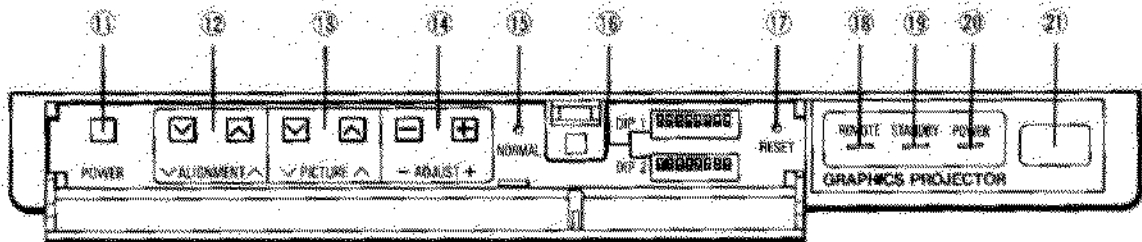

- ① POWER Button..... When the projector is in the stand-by mode (Main Power switch on, stand-by indicator lit) press this button to turn the projector on. When pressed again, it will return the projector to the stand-by mode.
- ② ALIGNMENT Up/Down Buttons ... V-HEIGHT, H-WIDTH, H-POSITION and V-HOLD can be selected by pressing these buttons. The on-screen display will change each time one of these buttons is pressed.
- ③ PICTURE Up/Down Buttons BRIGHT, CONTRAST, COLOR, TINT and SHARPNESS can be selected by pressing these buttons. The on-screen display will change each time one of these buttons is pressed.
- ④ ADJUST +/- Buttons..... These buttons adjust the level of the ALIGNMENT or PICTURE control selected. The level increases when (+) is pressed and decreases when (-) is pressed.
- ⑤ NORMAL Button This button returns the level of the ALIGNMENT control selected, or all PICTURE controls, back to the original factory preset levels.
- ⑥ DIP Switch 1, 2 These DIP switches set each operating mode of the projector. (See p.18 "DIP Switch Functions")
- ⑦ RESET Button..... Press to reset the projector after changing the DIP Switch settings.
- ⑧ REMOTE Indicator Flashes when the projector receives a signal from the remote control or when one of the buttons on the rear panel has been pressed.
- ⑨ STAND-BY Indicator..... Lights up when the projector's main POWER Button ① is pressed on.
- ⑩ POWER Indicator..... Lights up when the projector is in the stand-by mode and either the projector POWER Button ① is pressed or the remote control power key is pressed.
- ⑪ Infrared Light Receiver Section.... Receives the signal from the supplied remote control when used in the wireless condition.

REAR PANEL

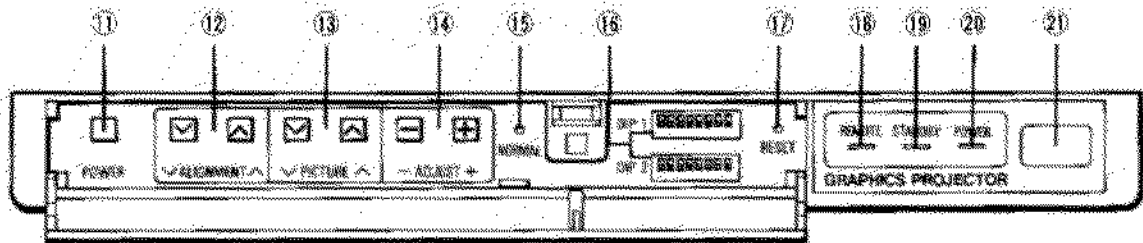

- ① POWER Button..... When the projector is in the stand-by mode (Main Power switch on, stand-by indicator lit) press this button to turn the projector on. When pressed again, it will return the projector to the stand-by mode.
- ② ALIGNMENT Up/Down Buttons... V-HEIGHT, H-WIDTH, H-POSITION and V-HOLD can be selected by pressing these buttons. The on-screen display will change each time one of these buttons is pressed.
- ③ PICTURE Up/Down Buttons..... BRIGHT, CONTRAST, COLOR, TINT and SHARPNESS can be selected by pressing these buttons. The on-screen display will change each time one of these buttons is pressed.
- ④ ADJUST +/- Buttons..... These buttons adjust the level of the ALIGNMENT or PICTURE control selected. The level increases when (+) is pressed and decreases when (-) is pressed.
- ⑤ NORMAL Button..... This button returns the level of the ALIGNMENT control selected, or all PICTURE controls, back to the original factory preset levels.
- ⑥ DIP Switch 1, 2..... These DIP switches set each operating mode of the projector. (See p.18 "DIP Switch Functions")
- ⑦ RESET Button..... Press to reset the projector after changing the DIP Switch settings.
- ⑧ REMOTE Indicator..... Flashes when the projector receives a signal from the remote control or when one of the buttons on the rear panel has been pressed.
- ⑨ STAND-BY Indicator..... Lights up when the projector's main POWER Button ① is pressed on.
- ⑩ POWER Indicator..... Lights up when the projector is in the stand-by mode and either the projector POWER Button ① is pressed or the remote control power key is pressed.
- ⑪ Infrared Light Receiver Section.... Receives the signal from the supplied remote control when used in the wireless condition.

3. FUNCTIONS OF REMOTE CONTROLS

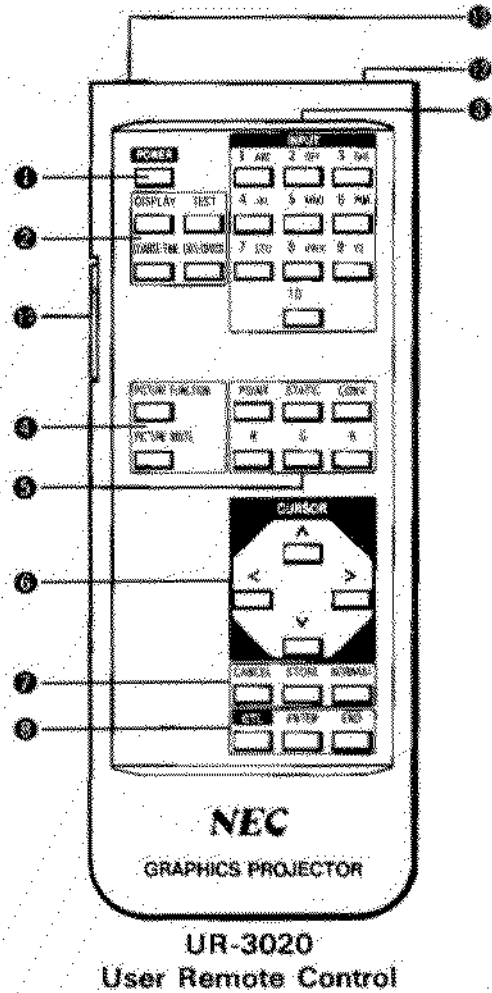
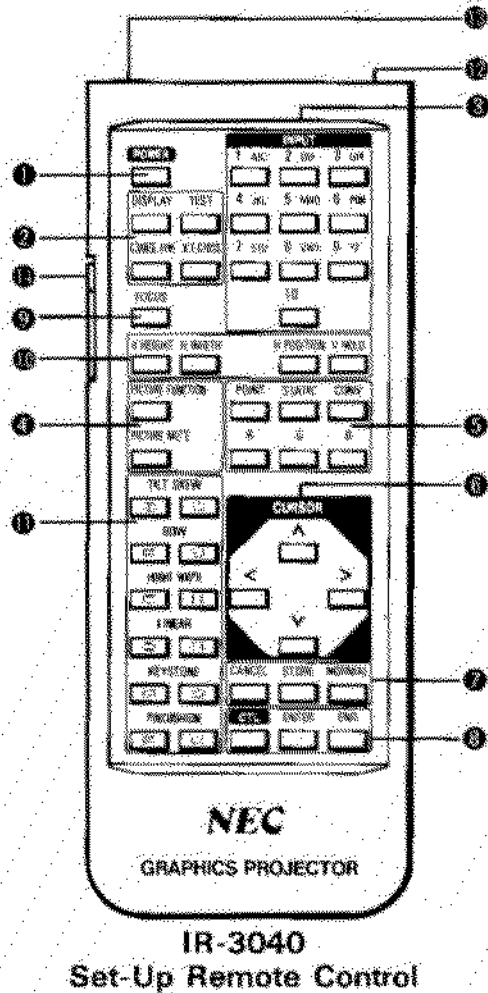

① **POWER Key** When the projector is in the stand-by mode and this key is pressed, the power goes on. When pressed again, the projector will return to the stand-by mode.



② **DISPLAY Key** Turns the on-screen display ON/OFF.

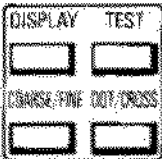

TEST Key Displays the adjustment pattern when pressed. When pressed again returns to the source screen.

COARSE/FINE Key When pressed, the adjustment pattern will change from Coarse to Fine. You can more accurately adjust convergence in either the dot or crosshatch pattern when the Fine pattern is selected. When pressed again, it will return to the Coarse pattern.

DOT/CROSS Key Each time this key is pressed, the pattern switches from dot to crosshatch and vice versa.

- 7 **CANCEL Key** Used to cancel stored convergence adjustments and to delete input signals in the Input Entry mode.



- STORE Key** Stores the condition of each control level and stores convergence adjustments (correction data).

- NORMAL Key** This key returns the condition of each control level to its original factory preset level. Or, when pressed with the CTL key, the control levels return to their most recently stored level.

NOTE: The CANCEL, STORE and NORMAL keys must be pressed twice in order to perform their function.

- 8 **CTL Key** This key is pressed and held down while using other keys, similar to a shift key on a typewriter.



- ENTER Key** This key is used for mode selection and for inputting the on-screen characters in the Input Entry mode.

- END Key** This key will end the adjustment mode and return the user to the image being displayed.

- 9 **FOCUS Key** This key will initiate the electrical focus adjustment control.



- 10 **V HEIGHT Key** This key will initiate the vertical height adjustment control.

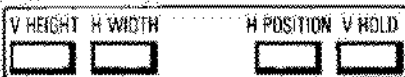

- H WIDTH Key** This key will initiate the horizontal width adjustment control.

- H POSITION Key** This key will initiate the horizontal position adjustment control.

- V HOLD Key** This key will initiate the vertical hold adjustment control.

- 11 **Dynamic Adjustment**

- Function Keys** When in the convergence adjustment mode, these keys select the dynamic convergence control to be adjusted: TILT, SKEW, V-BOW, H-BOW, HEIGHT, WIDTH, H-LINEAR, V-LINEAR, H-KEystone, V-KEystone, SIDE PINCUSHION, TOP/BOTTOM PINCUSHION.

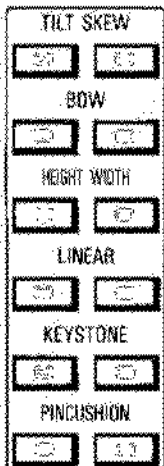

- ⑫ Remote Control Jack Insert the remote cable connector here to use the hand unit as a wired remote control.
- ⑬ Infrared Transmitter..... Outputs infrared signals when the remote control keys are pressed.
- ⑭ Back Light Switch..... Turns the back light ON or OFF.

Two Touch Keys

The Cancel, Store and Normal keys must be pressed twice in order to perform their function.

When pressed once, the confirmation message appears on the screen. When pressed the second time the message disappears and the function is executed.

NOTE: The LOAD function is not executed by pressing one key, but rather by pressing the CTL key and the NORMAL key (or CANCEL key in the convergence cancel operation)

The LOAD function allows you to return the control levels to their most recently stored level.

To perform the LOAD function:

Press the NORMAL key while pressing the CTL key to display "LOAD" on the screen, press them again. LOAD has been performed.

The CTL key is pressed simultaneously with other keys:

- CTL+ENTER..... To enter the ENTRY mode for input signal recording.
- CTL+NORMAL..... To return the control level to the previously stored set level.
- CTL+R,G,B..... To select the CRT to be adjusted.
- CTL+V,Λ,>,<..... To adjust the convergence at the cursor position.
- CTL+CANCEL..... To stop the convergence cancel operation and return to the status prior to cancellation. The "LOAD" message will appear on the left bottom of the screen.
- CTL+POINT..... To copy stored convergence information from one input to another.
- CTL+FOCUS..... To adjust the focus balance horizontally and vertically.
- CTL+V KEYSTONE..... To adjust the convergence for Vertical KEYSTONE balance.
- CTL+H KEYSTONE..... To adjust the convergence for Horizontal KEYSTONE balance.
- CTL+T/B PINCUSHION..... To adjust the convergence for top and bottom PINCUSHION balance.
- CTL+SIDE PINCUSHION... To adjust the convergence for side PINCUSHION balance.
- CTL+PICTURE FUNCTION. To adjust the GAIN control. Since the R, G and B GAIN are set at the optimal condition at the time of shipment, adjustment is normally not necessary.

1. INSTALLATION PROCEDURE

When this video projector is shipped from the factory, it is preset for the System Interface used, ceiling suspended, 100 inch screen front projection, but the installation method (ceiling suspension or floor installation) and the screen size (60 inch–300 inch) can be modified. See p. 28 "INSTALLATION METHOD CHANGES" for changing the installation method. When changing the screen size, see p. 31 "SCREEN SIZE CHANGE"

• Installation Drawing for 60, 100, 200 and 300 inch screens (diagonal)

The drawing on the following page shows the relative positional relationship of the projector with the screen. When the projection distance changes $\pm 1\%$ more than the displayed value, it may be necessary to readjust the position setting. The length, height and depth will determine the screen size to be used.

A	Distance between the lens and the screen
B	Distance between the top of the supplied ceiling mount bracket and the screen center
C	Distance between the wall and the bolt
D	Distance between the desk top and the screen center
E	Distance between the ceiling and the top of the supplied ceiling mount bracket

NOTE: When the screen size is changed, do not forget to adjust the focus.

Sizes not found between 60 and 300 inches are determined by the following proportional calculation formula.

Units = inches S = screen size (diagonal)

$$A = \left(\frac{S}{4.8} + 1\right) \times 5.315 + 7.345$$

$$B = 0.191 \times A + 11.22$$

$$C = 0.981 \times A + 7.913$$

$$D = 0.191 \times A + 8.858$$

$$E = 1/2 \text{ Screen Height} - B$$

NOTE: For screen sizes over 160" diagonal, the projector will need to be mounted with an adjustable suspension adaptor at a minimum distance from the ceiling equal to E.

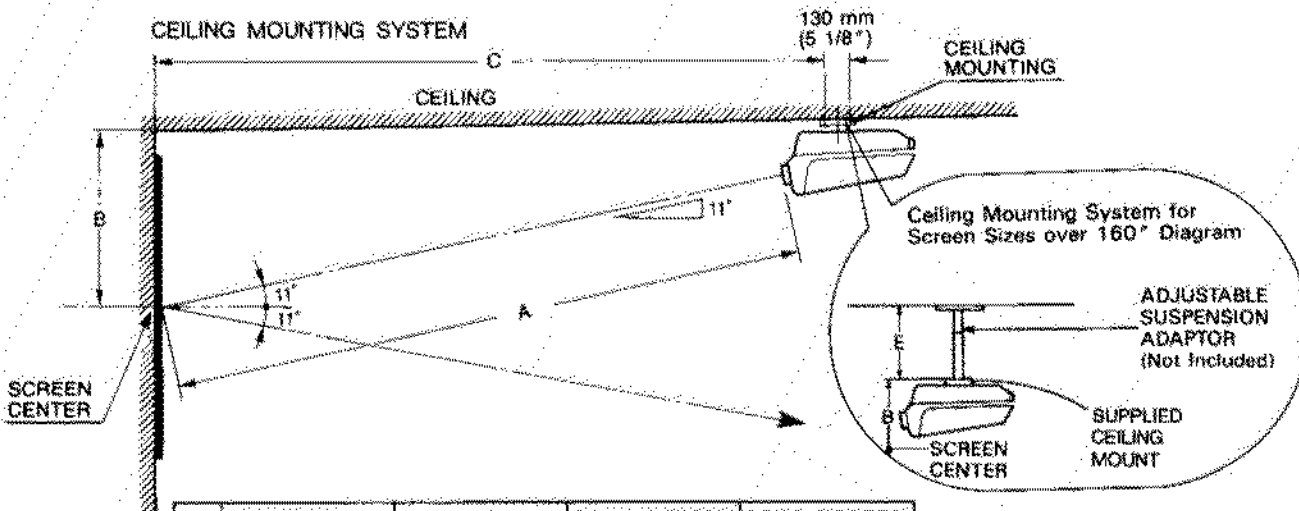

	60" SCREEN	100" SCREEN	200" SCREEN	300" SCREEN
A	79 1/8"	123 3/8"	234 1/8"	344 7/8"
B	26 3/8"	34 3/4"	55 7/8"	77"
C	85 1/2"	129"	237 9/16"	346 3/16"
E	—	—	At least 4 1/8"	At least 13"

4. DIP SWITCH FUNCTIONS

Pin Explanation

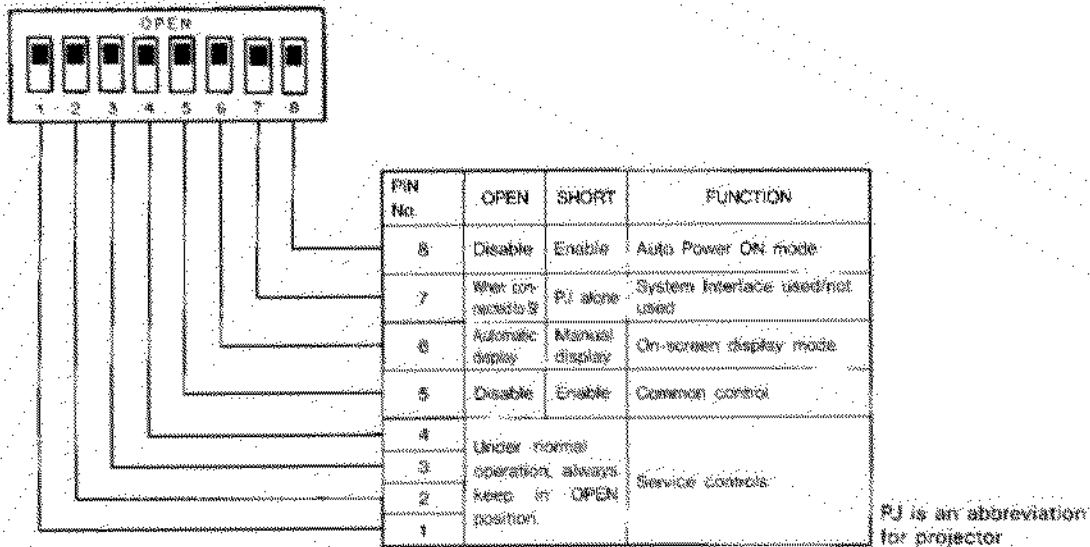

DIP Switch 1

- No. 8** This switch sets the auto power on mode. It is activated by setting this switch to SHORT. The auto power on mode is a convenient way for the user to start up the projector without pressing the power button on the projector or the remote control. For example, this mode would be used when the user desires to turn the projector on and off through a switched AC outlet.
- When this switch is set to OPEN, the projector is turned on and off by pressing either the power button on the remote control or on the back of the projector.
- In both of the above conditions, the MAIN power switch on the front of the projector must be in the stand-by mode to operate.
- No. 7** Switch to the SHORT side when the projector is being used alone. When being used with the System Interface (SI-5320), switch to the OPEN side.
- No. 6** This switch changes the on-screen display mode. When set to the OPEN side, the on-screen display appears when the remote control keys are pressed. The display will stay on for about 5 seconds. When set to the SHORT side, the on-screen display will not appear when switching between sources. However, it will appear when any of the other function keys are used and will stay on-screen until the DISPLAY key is pressed. In either the OPEN or SHORT position, the on-screen display can be turned ON or OFF by pressing the DISPLAY key.

No. 5

Common control mode

Set pin number 5 on DIP switch 1 to the SHORT side to activate the COMMON CONTROL MODE. All adjustment commands input from the remote control and rear panel will now affect each of the video signals (max. 24) simultaneously. There are three situations that pin No. 5 can be used. They are as follows:

Situation 1.

When the distortion and erroneous convergence apparent from the image projected on the screen are caused by the physical position between the screen and the projector, regardless of the input signal itself. In the same way, when focusing problems stem more so from internal causes rather than the individual input signal. The common control mode is used by first either canceling or normalizing all adjustment data and then activating the common control mode. This will allow you to attend to a single input signal and adjust focus, alignment, picture and convergence (except point convergence) which, once completed, can be stored in memory. This will eliminate the distortion and convergence errors seen commonly in all of the signals. Thus, you are left with a minimum of individual signals for fine adjusting. Set pin number 5 on DIP switch 1 to the OPEN side and disable the common control mode so that you can make the necessary fine adjustments.

Situation 2.

Over an extended period of use, the projector will be subject to both internal and external effects that will put the optimum adjustment out of line. This type of disorder will commonly affect all of the signals, and thus can be corrected conveniently with the common control mode.

Situation 3.

If you have used the common control mode to adjust the signals, a newly added signal will not require the rough adjustment usually necessary. This will cut down adjustment time and require only fine adjustments.

Nos. 4, 3, 2 and 1

Primarily for serviceman use only. They should normally be set to the OPEN position.

DIP Switch 2

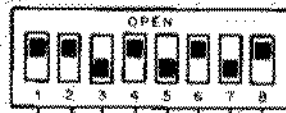

PIN No.	Setting		FUNCTION
	OPEN	SHORT	
8	For normal operation, always keep in the OPEN position.		Not used
7	See TABLE 1		Signal select switcher when PJ is started up.
6			
5			
4	See TABLE 2		Installation condition of PJ
3			
2	For normal operation, always keep in the OPEN position.		Service controls
1			

No. 8 Primarily for serviceman use only. It should normally be set to the Open position.

Nos. 7, 6 and 5 Sets the input signal selected when the projector is started up.

TABLE 1

S	B	7	When SI-5320 Used	When Projector Only
0	0	0	VIDEO 1	VIDEO
1	0	0	VIDEO 2	RGB
0	1	0	RGB 1	Not used
1	1	0	RGB 2	Not used
0	0	1	RGB 3	Not used
1	0	1	Not used	Not used
0	1	1	Not used	Not used
1	1	1	Not used	Not used

0=SHORT
1=OPEN

Nos. 4 and 3 Set according to projector installation method.

TABLE 2

3	4	Installation Method
0	0	Ceiling/Rear projection
0	1	Ceiling/Front projection
1	0	Floor/Rear projection
1	1	Floor/Front projection

0=SHORT
1=OPEN

These settings are for when the image is projected from the projector directly onto a screen. When projected by reflecting on a mirror, etc. it is not limited to these settings. It is preset at the factory for "ceiling mounting/front projection." Also, when the installation method is changed, the polarity and spacers may need to be changed (See p.29 and p.32).

Nos. 2 and 1 Primarily for serviceman use only. They should normally be set to the OPEN position.

NOTE: Press the RESET button on the projector or turn off the POWER after setting DIP switches.

FACTORY SETTINGS OF THE DIP SWITCHES

The following table shows the original factory settings of DIP Switch 1 and DIP Switch 2.

	PIN no.	Setting	Remark
DIP SW1	1	OPEN	Service controls
	2	OPEN	
	3	OPEN	
	4	OPEN	
	5	OPEN	Common control mode : Disabled
	6	OPEN	Automatic on-screen display
	7	OPEN	System Interface used
	8	OPEN	Auto Power ON mode : Disabled
DIP SW2	1	OPEN	Service controls
	2	OPEN	
	3	SHORT	Ceiling mounting
	4	OPEN	Front projection
	5	SHORT	The input signal selected when the projector is started up : RGB1
	6	OPEN	
	7	SHORT	
	8	OPEN	Not used

5. REMOTE 1 Terminal

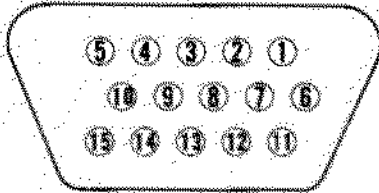

The REMOTE 1 Terminal is used for either connecting the System Interface (SI-5320) or an external control device.

- 1, 2, 6, 7, 11 and 12 Sending and receiving data when the System Interface is used.
- 3 Input signal selection
- 13 Input for external remote control data
- 4, 8 and 9 Normally set to OPEN.
- 14 Use/non-use of external control
- 5 POWER ON/OFF
- 10 PICTURE MUTE ON/OFF
- 15 Ground

When the System Interface is used, connect it with the supplied remote cable (15–25 pin) to this terminal.

PIN No.	SHORT / OPEN	FUNCTION
⑩	SHORT OPEN	External control mode ON External control mode OFF
⑤	SHORT OPEN	POWER ON POWER OFF
⑩	SHORT OPEN	PICTURE MUTE ON PICTURE MUTE OFF
③	SHORT OPEN	VIDEO RGB

SHORT means to connect with pin 15

When in the external control mode, the POWER, INPUT and PICTURE MUTE keys on the remote control will not function.

Pin 13 is the external remote signal terminal. The projector can be controlled by the same composite signal from the external controller.

PART II
INSTALLATION

TABLE TOP SYSTEM

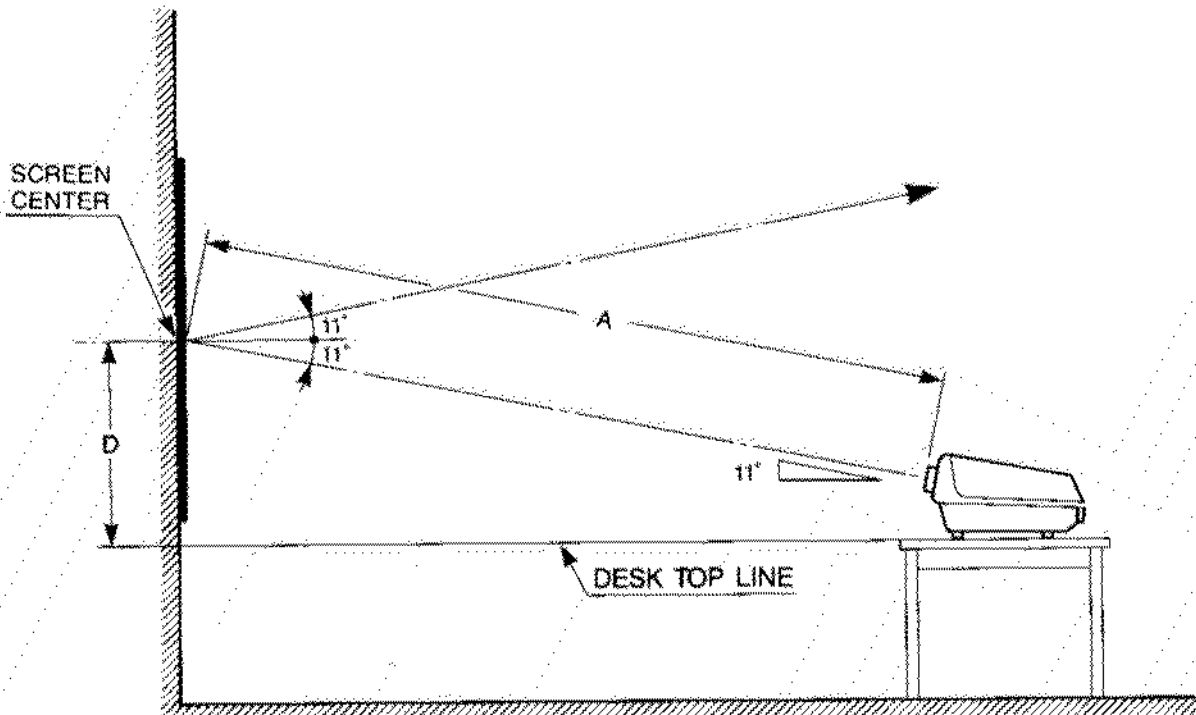

	60" SCREEN	100" SCREEN	200" SCREEN	300" SCREEN
A	79 1/8"	123 3/8"	234 1/8"	344 7/8"
D	23 15/16"	32 3/8"	53 9/16"	74 11/16"

REAR PROJECTION SYSTEM

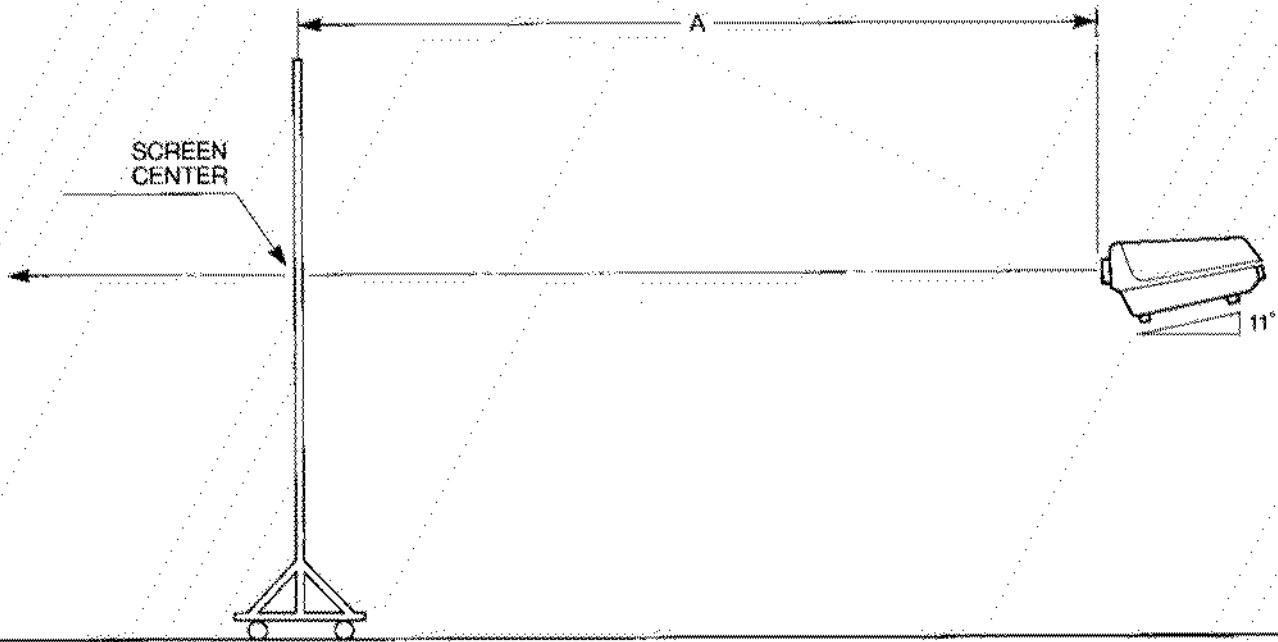

	60" SCREEN	100" SCREEN	200" SCREEN	300" SCREEN
A	79 1/8"	123 3/8"	234 1/8"	344 7/8"

2. CEILING INSTALLATION

To assure safety, when a ceiling bracket is installed, be sure to use the supplied ceiling mounting kit.

NOTE: The ceiling must have sufficient strength to support the projector weight (132 lbs).

- (1) Determine the relative relationship between the projector and the screen according to the screen size. (See p.24, 25 for examples of screen sizes).
- (2) Attach mounting (A) to the ceiling. Use four 10mm coarse thread screws (not included).

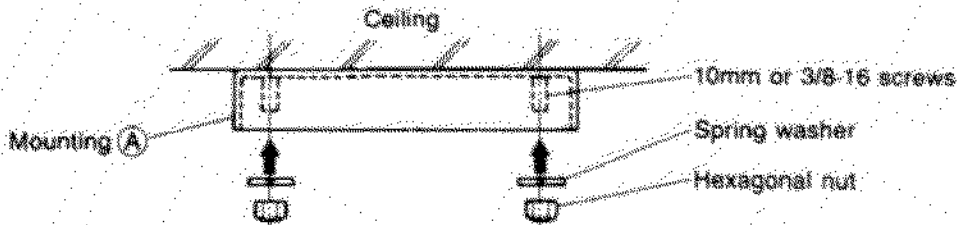

(When not using an adjustable suspension adaptor.)

- (3) Attach brackets (B) and (C) to the bottom of the projector.

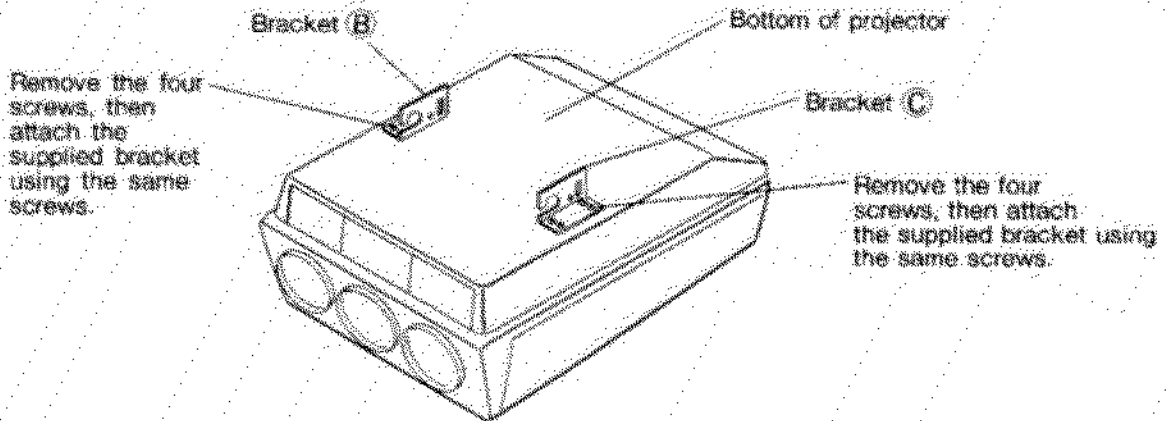

- (4) Line up the projector brackets with the protruding section of mounting (A) and fit them in securely.

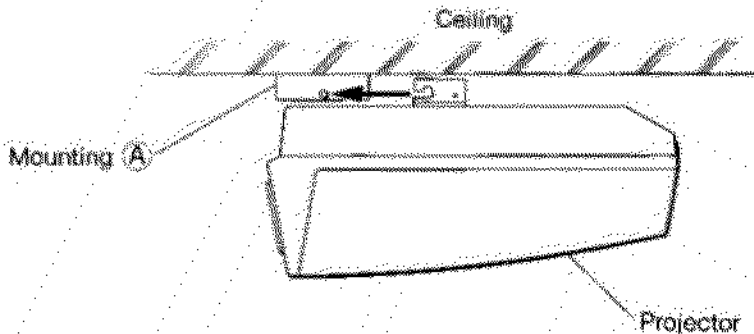

(5) Install the special bolt and the M4 screw as shown in the below drawing.

If mounting for a 11° projection angle, that is, the bottom face of the projector is set parallel to the ceiling, attach two M4 screws to each B & C bracket as shown in the diagram below. If setting for other than a 11° projection angle, attach only one M4 screw to the outer slot of each B & C bracket.

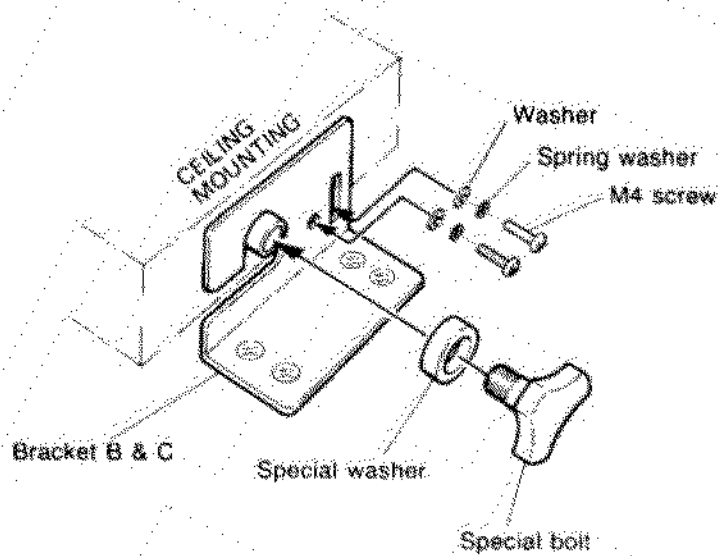

(6) Projector attached to ceiling installation position.

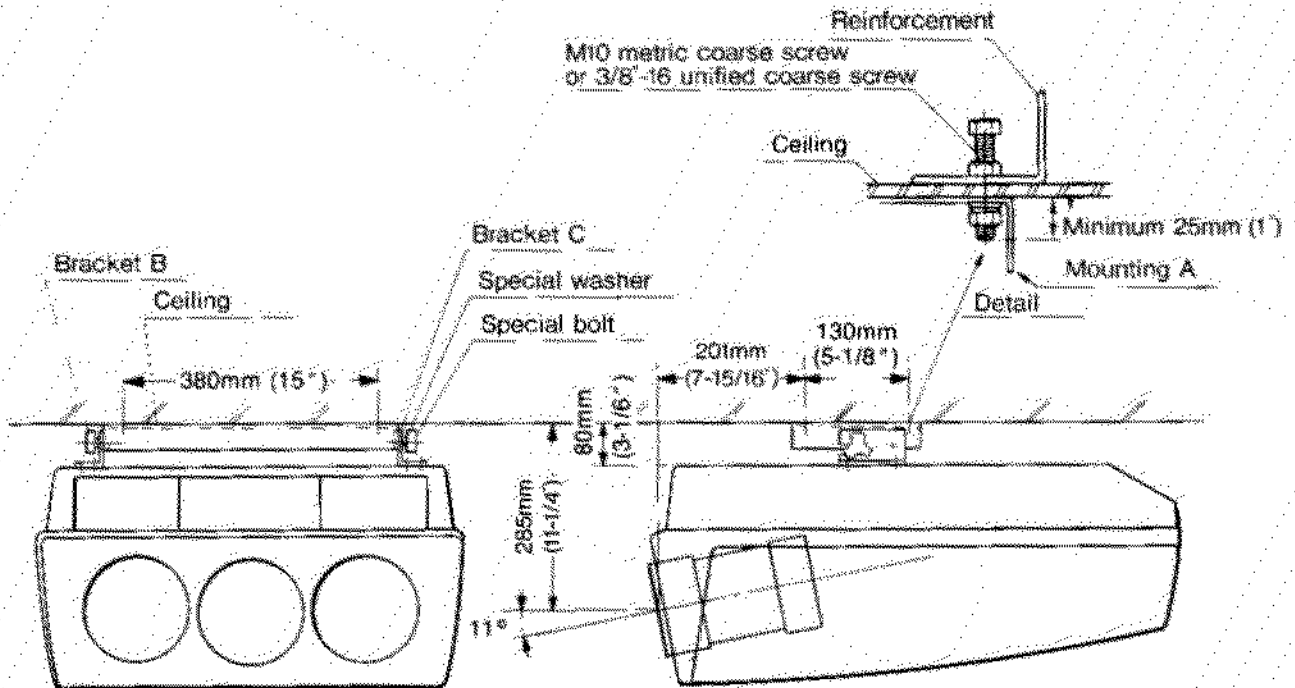

When changing from ceiling mounting to floor use, turn over the plate with the NEC trademark in the rear of the top cover.

Push the catch from the inside and remove the plate. Install it in the opposite manner.

3. INSTALLATION METHOD CHANGE

When the projector installation is changed from ceiling mounted type to floor type or from floor type to ceiling mounted type, pin No. 3, 4 of DIP switch 2, and the horizontal and vertical polarity must be changed.

NOTE: The projector is preset at the factory for 100 inch, ceiling mounting and front projection. When the projector is used in this condition, it is not necessary to change the polarity and pin No. 3, 4 of DIP switch 2.

(1) DIP Switch 2 Setting

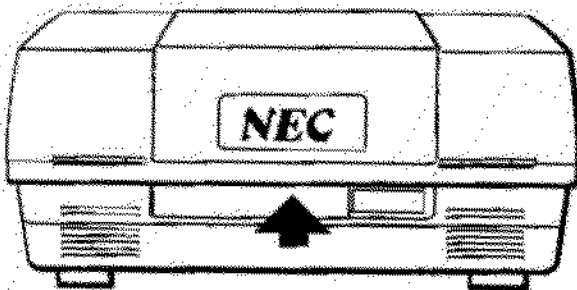

The DIP switches are in the rear panel.
Push and open the control cover on the back of the projector.

Nos. 4 and 3 Set according to projector installation method.

3	4	Installation Method
0	0	Ceiling/Rear projection
0	1	Ceiling/Front projection
1	0	Floor/Rear projection
1	1	Floor/Front projection

0=SHORT
1=OPEN

These settings are for when the image is projected from the projector directly onto a screen. When projected by reflecting on a mirror, etc. it is not limited to these settings. It is preset at the factory for "ceiling mounting/front projection."

NOTE: Press the RESET button on the projector or turn off POWER after setting Nos. 4 and 3 pins.

(2) Polarity Change

1) Opening Top Cover

- Check to make sure the power is OFF and remove the power cord from the socket.
- Loosen the two (A) screws. However, leave the top cover attached.
- Raise the top front of the projector, then open the top cover until the hinges lock.

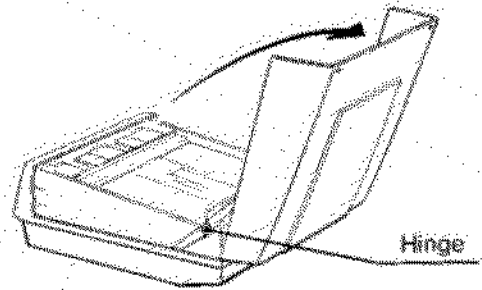
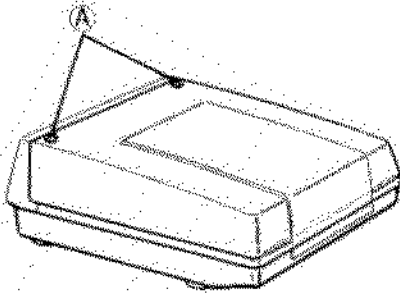

2) Polarity Reversal

The below drawing shows the position for the horizontal and vertical polarity connectors inside the projector.

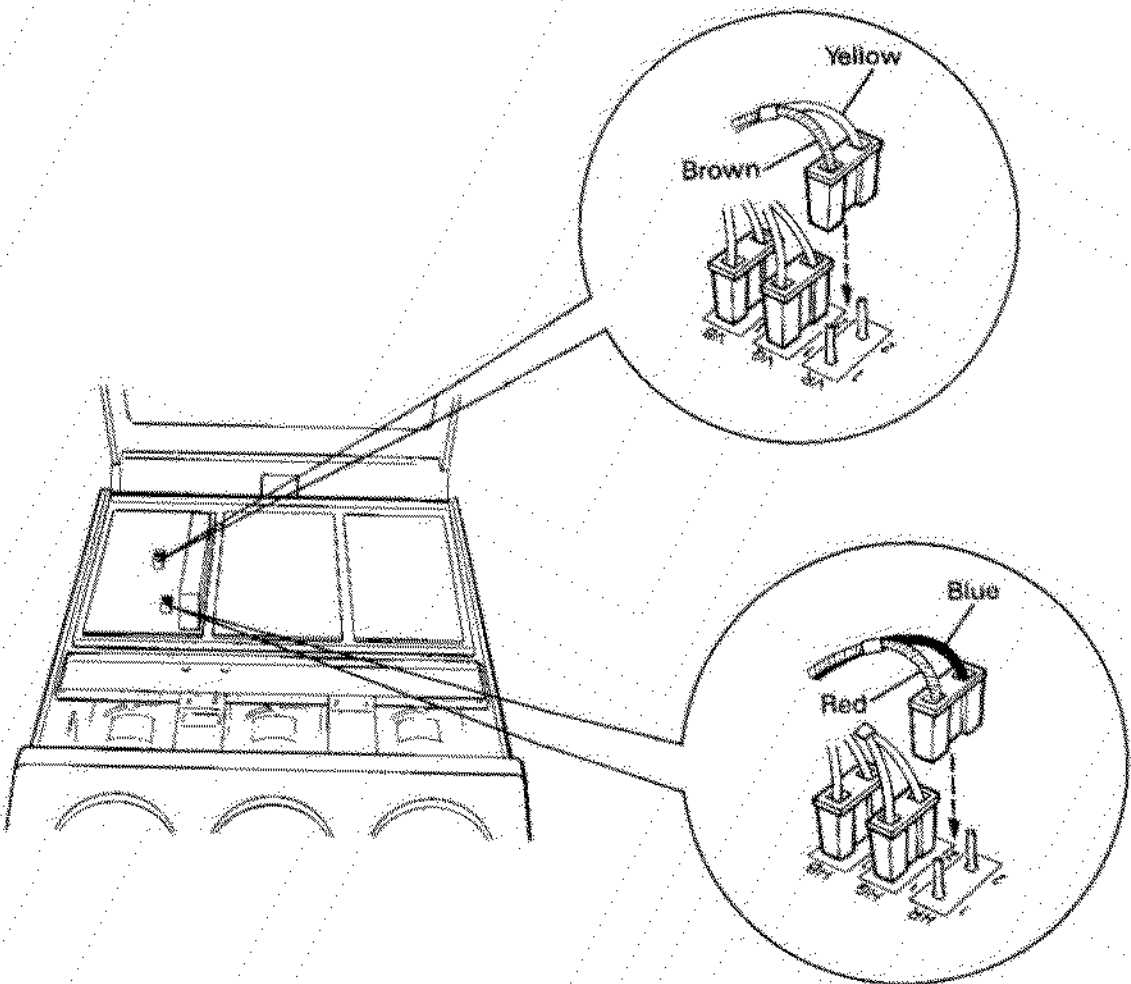

Polarity Table

Setting	Connector	HR, HG, HB		VR, VG, VB	
	Pin	① Lead	② Lead	① Lead	② Lead
Front	Ceiling	Red	Blue	Brown	Yellow
Front	Floor	Blue	Red	Yellow	Brown
Rear	Ceiling	Blue	Red	Brown	Yellow
Rear	Floor	Red	Blue	Yellow	Brown

Modification of each connector

Correctly connect the three horizontal connectors and three vertical connectors as shown in the below drawings. In this case, be sure to connect the same set of pins. (In other words do not confuse R, G and B).

Front ceiling
Rear floor

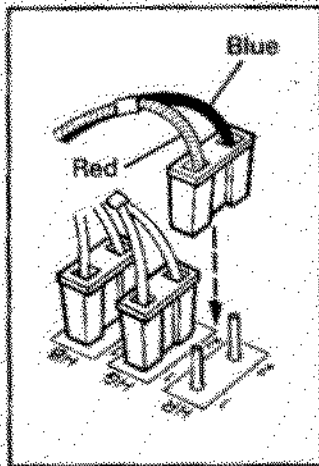

HORIZONTAL

Front ceiling
Rear ceiling

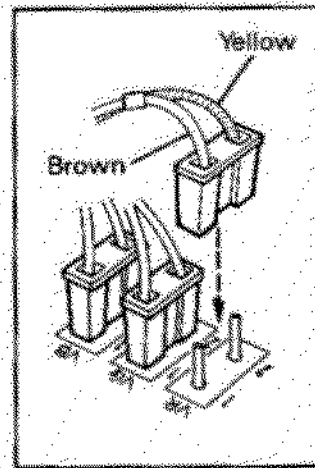

VERTICAL

Front floor
Rear ceiling

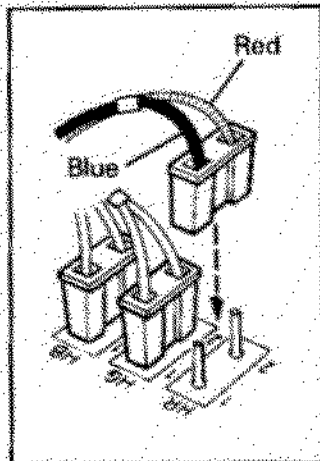

Front floor
Rear floor

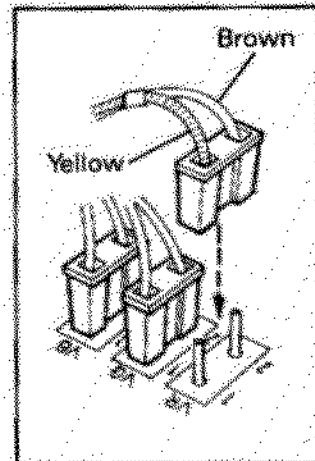

NOTE: Leads 1 and 2 are printed on the circuit board next to the corresponding pins.

When changing from ceiling mounting to floor use, and vice-versa, turn over the plate with the NEC trademark in the rear of the top cover.

Push the catch from the inside and remove the plate. Install it in the opposite manner.

4. SCREEN SIZE CHANGE

When the screen size is changed from 100 inches to 60 inches, 200 inches and 300 inches, proceed as follows:

(1) Preparation

- (a) Check to make sure the power is OFF, then open the top cover. (See p. 29)
- (b) Remove the four (A) screws on both sides of the projector and remove the front panel.

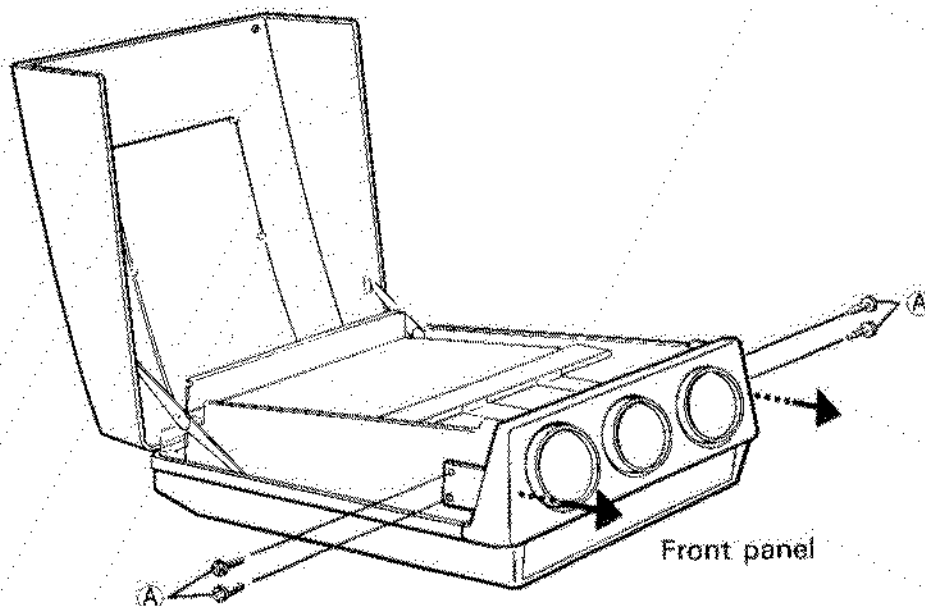

(2) Changing the Position of Decorative Boards

- (a) Loosen the screws at the four points on the two left and right decorative boards located on the reverse side of the front panel.
- (b) Slide the decorative boards to match the screen size.
- (c) Tighten the four screws.

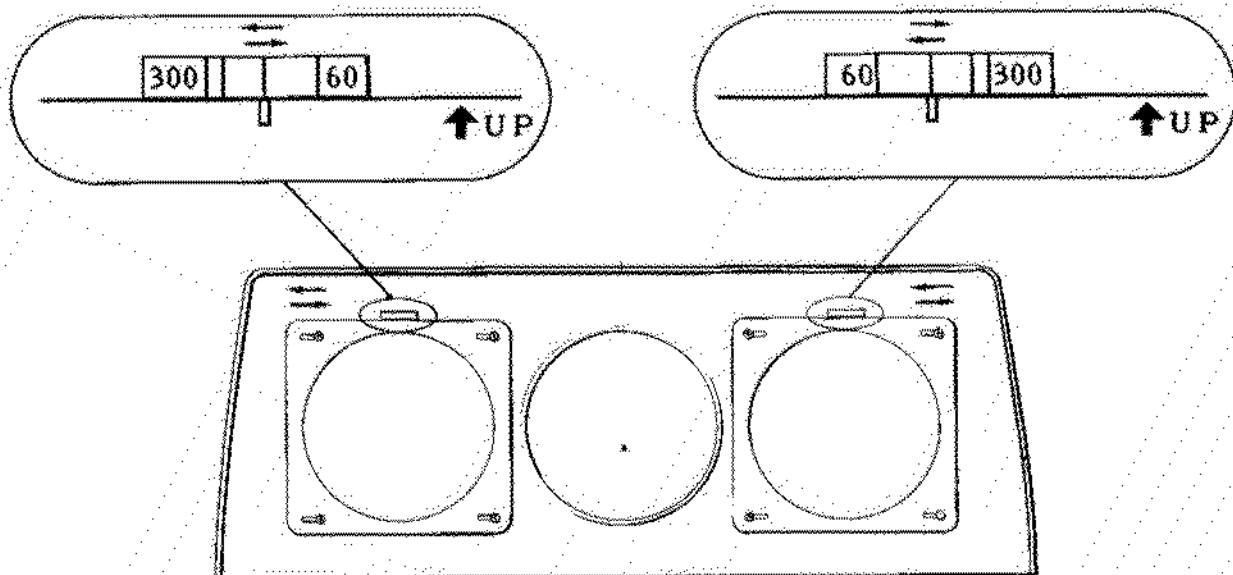

5. SPACER INSTALLATION

If changing from a 100 inch screen to a 60 inch, 200 inch or 300 inch screen, it will be necessary to change the CRT spacers according to the screen size and the projection angle to be used. To install the accessory spacers, proceed as follows:

- (1) Remove the four **B** screws holding the two PWB mountings.
(See page 29 and 31 for opening the top cover and removing the front panel)

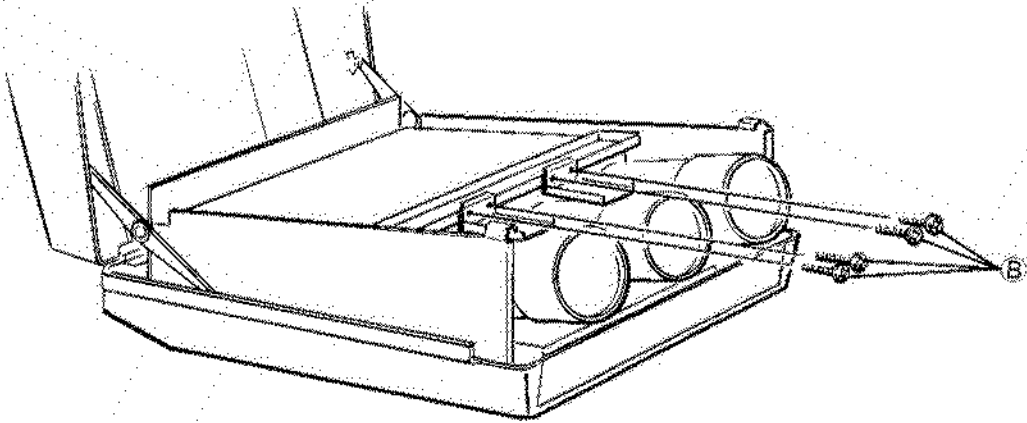

- (2) Remove the four **C** nuts in the red, green and blue lenses and take out the lenses.

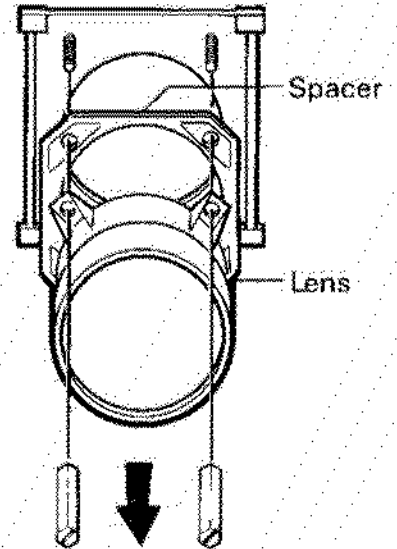
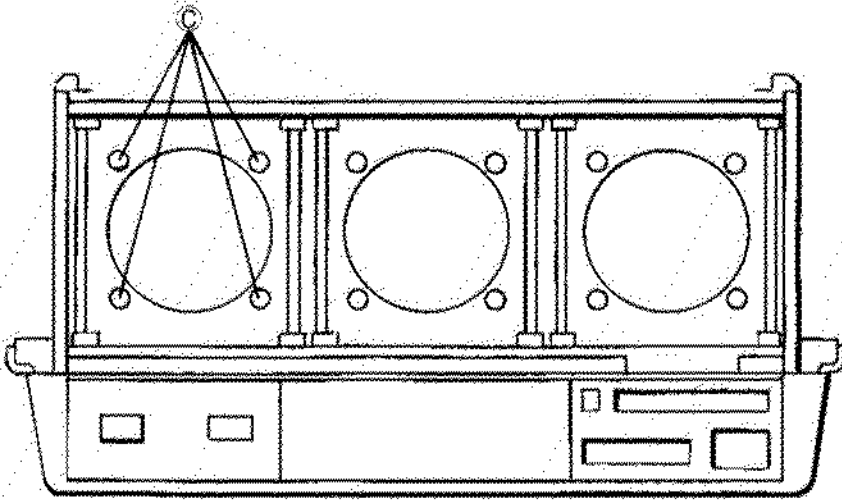

(3) a) Remove the spacer on the inside.

b) Install a spacer matching the screen size and projection angle needed. Attach by setting the side with the arrow on top.

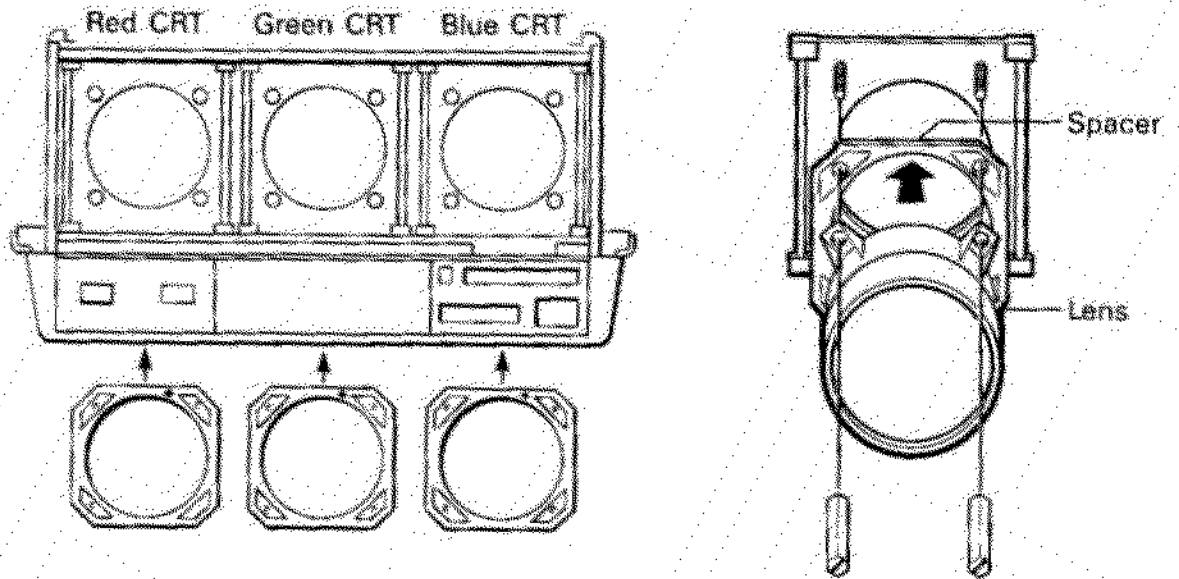

• LIST OF SPACERS FOR ANGLE REGULATION

SCREEN SIZE and PROJECTION ANGLE	CRT			
	R	G	B	
60° 11"	A	D	A	ACCESSORY
100° 11"	B	E	B	NORMAL POSITION
200° or over 11"	C	F	C	ACCESSORY
60° 0°	G	I	G	ACCESSORY
100° 0°	H	I	H	ACCESSORY
200° or over 0°	I	I	I	ACCESSORY

Install an angle adjustment spacer corresponding to the screen size and projection angle as per the above list.

NOTE: For A, B, C, G and H, the reverse side corresponds to R or B.

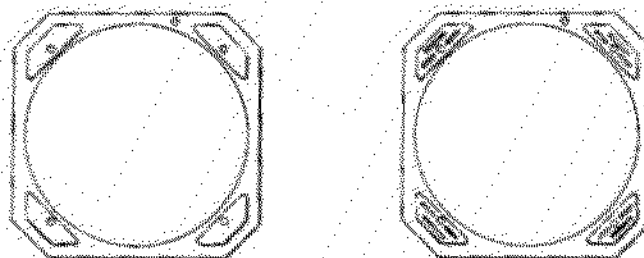

Spacers

6. ADJUSTING THE ANGLE OF CRTs

- Loosen the two (D) screws and one (E) screw on the CRT mounting for the red and blue CRTs.
- Remove screw (F).
- Move the red and blue lens and match to the screen size holes that are carved into the CRT mounting, then tighten screws (D), (E) and (F).

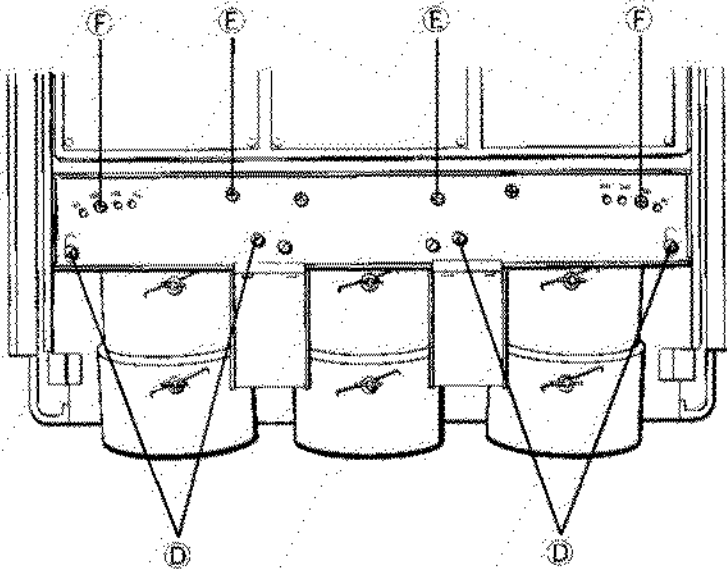

Adjust the lens focus. (See p. 39)

NOTE: For a screen not described on the CRT mounting, refer to the table below. For instance, if setting for a 100 inch to 110 inch screen, changing the position of the decorative boards and adjusting the angles of the CRTs will not be necessary. However, when using the projector for rear projection, you must change the spacers for the angle.

SCREEN SIZE	60 inch	100 inch	200 inch	300 inch
RANGE OF SCREEN SIZE	60" ~ 75"	75" ~ 130"	130" ~ 240"	240" ~ 300"

PART III

SET UP REMOTE CONTROL OPERATION CONVERGENCE

1. OPERATION PROCEDURE

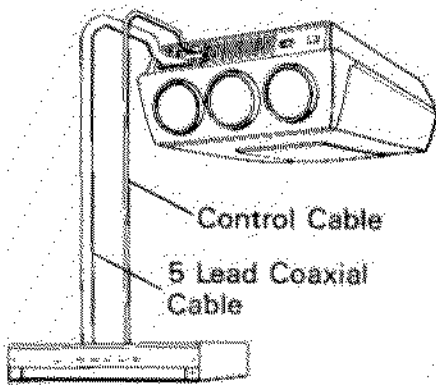

The Projector is adjusted for use with the System Interface, ceiling mounting, 100 inch screen, front projection at the factory. When changing the installation method and screen size, see p.28-31.

Preparation prior to operation

- (1) The System Interface is connected with the video projector by means of a control cable and a 5 lead coaxial cable. (both included with System Interface)
- (2) Connect the external equipment. (See p. 10 and 11 "Connection Example")
- (3) Connect the power plug for the projector and System Interface to an AC 120V, 60 Hz socket.

Operating Procedure

- (1) Turn on the external equipment power.
- (2) Turn the POWER switch on the back of the System Interface ON. The POWER indicator on the System Interface will light in red.

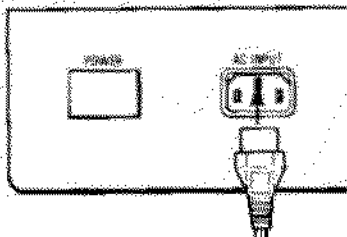
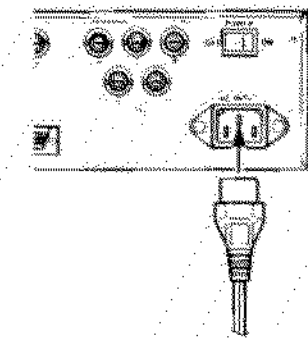

- (3) Turn ON by pressing the POWER button (main power switch) on the front of the projector. The STAND-BY indicator will light up (When pin No. 8 of dip switch 1 is on the Open side.)

NOTE: When pin No. 8 of DIP switch 1 is on the Short side and the POWER button on the front of the projector is turned ON, the projector will start up.



- (4) Press the POWER button on the back panel of the projector or the POWER key on the remote control. The projector REMOTE indicator and POWER indicator will light up and the POWER indicator on the System Interface will light in green.

NOTE: When the No. 8 pin of DIP Switch 1 is on the Short side it is not necessary to press the POWER button on the back of the projector or on the remote control.



NOTE: Flashing of the STAND-BY indicator on the projector means that the projector might not be connected with the System Interface correctly or the System Interface might not be turned ON.

In that case, check the connection of the 15-25pin remote cable and make sure the POWER indicator on the System Interface is lighted in red.

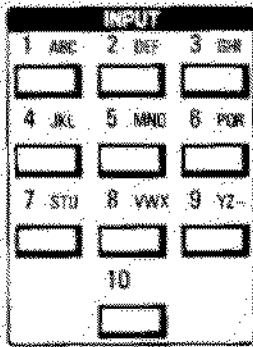

- (5) The image is projected on the screen.
- (6) Select the desired input terminal from among the INPUT keys 1-5 of the remote control. The corresponding indicator on the System Interface will light up and the input signal image selected will be projected on the screen. When INPUT keys 1-5 are pressed, the input terminals for VIDEO 1 and 2 and for RGB 1, 2 and 3 can be selected as follows:

INPUT 1.....	VIDEO 1
INPUT 2.....	VIDEO 2
INPUT 3.....	RGB 1
INPUT 4.....	RGB 2
INPUT 5.....	RGB 3

NOTE: If the NO INPUT, CHECK INPUT LIST messages appear on the screen, first perform "input signal recording" (See p. 51-58).

Infrared light receiver section

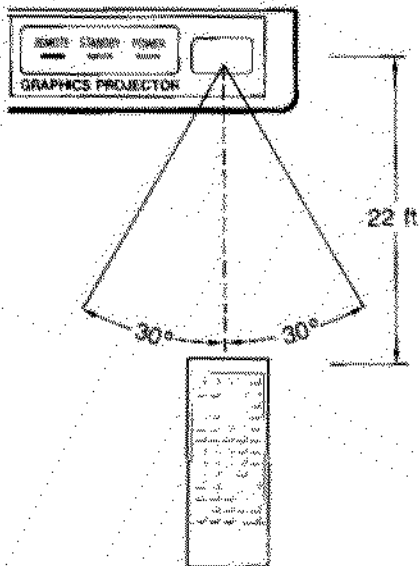

Precautions when Using Remote Control

- (a) There are infrared light receiver sections and remote jacks on both the projector and System Interface. Either can be used at the same time.
- (b) When the remote control is used with the remote cable, it is connected to the REMOTE 2 jack on the front of the System Interface or the front of the projector.
- (c) Use the wireless remote control within the valid operating range. When strong light strikes the infrared light receiver section or there are obstructions between the remote control and the infrared light receiver section it will not operate correctly.

2. ADJUSTING THE CENTERING MAGNETS

- (a) Cancel static convergence. (See p. 47)
- (b) Loosen the two ⓑ screws, then raise the upper chassis.

NOTE: Screws ⓑ cannot be removed from the upper chassis.

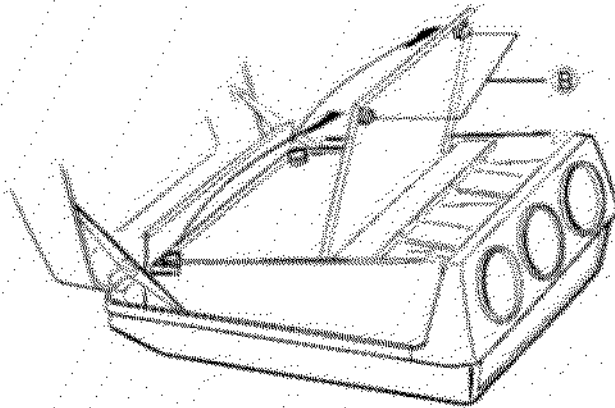

- (c) Press the TEST key.

A crosshatch pattern will be projected. Turn off the red or blue CRT by pressing the R or B key on the remote control. Adjust the R or B centering magnet being projected and match it to the pattern corresponding to green. Project the R or B CRT, which was turned off in advance by the same method, then turn off the remaining CRT and adjust to the corresponding green pattern.

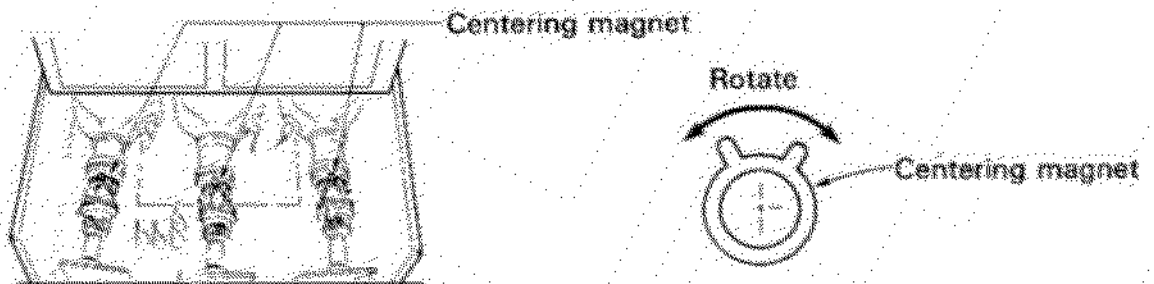

NOTE: If focus cannot be optimally adjusted, adjust the C.P.C. magnet, referring to the service manual. When the centering magnet has been substantially moved, the C.P.C. magnet must be adjusted.

- (d) Turn off the power. Install the two ⓑ screws, attach the upper chassis.

3. LENS FOCUS ADJUSTMENT

- (1) Turn the power ON.
- (2) Press the remote control TEST key and display the crosshatch pattern.
- (3) Press the two R, G or B keys that you don't want to adjust, then only the CRT you want to adjust will be projected.



Example

Green pattern



Red pattern



Blue pattern



- (4) Loosen wing nut (A) while each respective CRT is displayed, rotate the lens, then adjust the focus of the center section of the screen to its optimum focus. Tighten wing nut (A). Likewise loosen wing nut (B) and adjust the peripheral area of the screen. Tighten wing nut (B). Again loosen wing nut (A) and adjust the focus of the center. Tighten wing nut (A) after the adjustment has been completed.

NOTE: Do not overtighten the wing nuts.

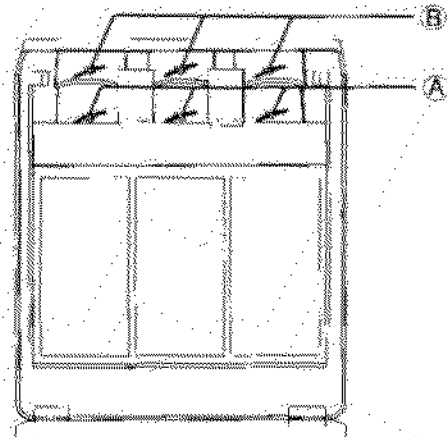
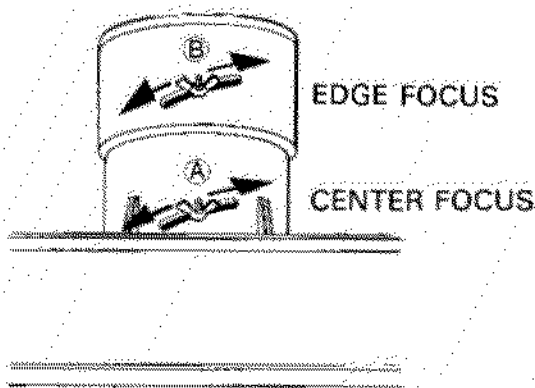

NOTE: To focus the image more precisely, adjust the focus in the most detailed display area within the input being used (test pattern off). At this time the individual CRT cannot be cut off, so cover the CRT's not being adjusted with a lens cap.

4. ELECTRICAL FOCUS ADJUSTMENT

- (1) Select and press the signal you wish to adjust from INPUT keys 1-5 and project an image.
- (2) Press the TEST key and display the crosshatch pattern.

NOTE: You can also adjust electric focus on the normal screen.

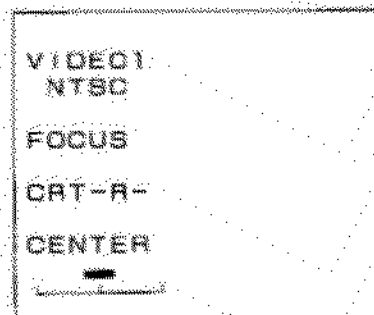
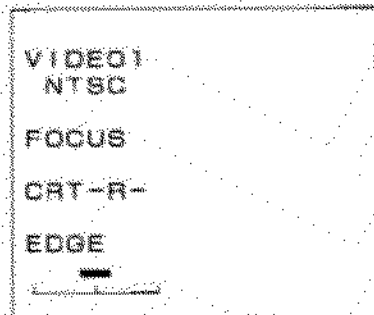

- (3) Press the FOCUS key to initiate the FOCUS adjustment mode.
- (4) Select the CRT you wish to adjust by pressing either the R, G or B key while pressing the CTL key.
When you wish to delete a signal other than the CRT you want to adjust, you can turn each CRT beam ON/OFF by pressing the R, G and B keys.
- (5) Select the CENTER or EDGE adjustment by pressing the FOCUS key. Each time the FOCUS key is pressed the CENTER and EDGE adjustments are alternately selected.
- (6) Adjust the optimum focus by pressing the cursor key <, >, ^ and v. The cursor keys ^ and > move the level up. v and < move the level down.
- (7) When you change the CRT to be adjusted, repeat steps (4)-(6).
- (8) Once the adjustment of the focus has been completed, press the STORE key. "STORE" appears on the screen. Press the STORE key once more to complete the store procedure.
- (9) Terminate the FOCUS adjustment mode by pressing the END key.

NOTE: For CENTER adjustment, adjust by watching the center of the screen. For EDGE adjustment, adjust by watching the 4 corners of the screen.

The following instructions are primarily for serviceman.

H/V Balance (Focus Control)

The H/V balance controls the H-width and V-height focal balance to an optimum setting whenever an input signal changes.

- ① This adjustment is made on a green CRT display. With the test pattern on screen, press the R and B keys to display the Green CRT only.
- ② Press the FOCUS key to initiate the FOCUS adjustment mode. Select the EDGE adjustment to adjust the optimum H-width focus with the cursor keys while watching the edge marked A in Fig. 1. Be sure the Green CRT is selected by pressing the CTL and G keys.
- ③ Press the CTL key and hold it down while you press the FOCUS key. The following display Fig. 2 will appear. Adjust the optimum V-height focus by pressing the cursor keys <, >, ^, and v while watching the edge marked B in Fig. 2.
- ④ Store this adjustment by pressing the STORE key twice. Repeat steps (3) - (9) above.

Note: Make this adjustment for each individual input signal.

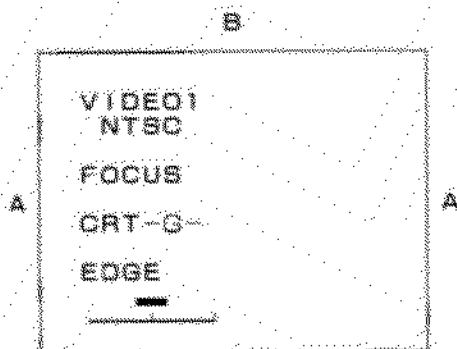

Fig.-1

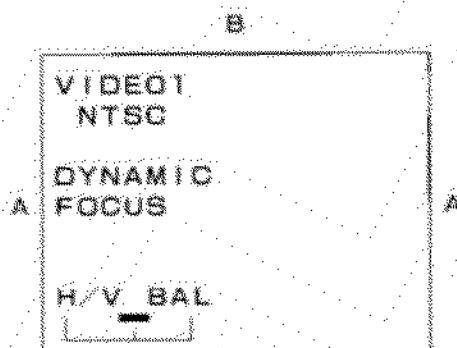

Fig.-2

5. ALIGNMENT ADJUSTMENT



(1) Select the signal to be adjusted using the INPUT keys 1-5 and project an image.

(2) Select the function to be adjusted by pressing one of the keys V-HEIGHT, H-WIDTH, H-POSITION and V-HOLD.

(3) Adjust to the optimum level by pressing the cursor keys <, ^, > and v. When ^ and > are pressed the level increases, when < and v are pressed the level decreases.

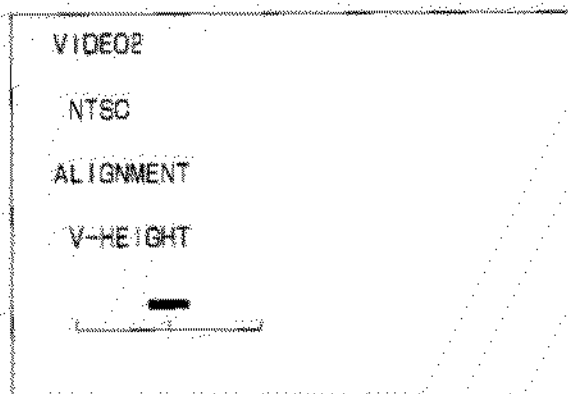

(4) When adjusting the remaining functions, repeat from step (2).

(5) When adjustment is completed, press the STORE key. "STORE" appears on the screen. Press the STORE key once more to complete the store procedure.



(6) Terminate the ALIGNMENT adjustment mode by pressing the END key.

NOTE: When the test pattern is displayed only V-HEIGHT and H-WIDTH operate. When the ALIGNMENT has been adjusted, the EDGE focus may change slightly. At such times the focus should again be adjusted.

NOTE: The selection of the function to be adjusted can also be done using the ALIGNMENT up and down buttons in the projector rear panel.

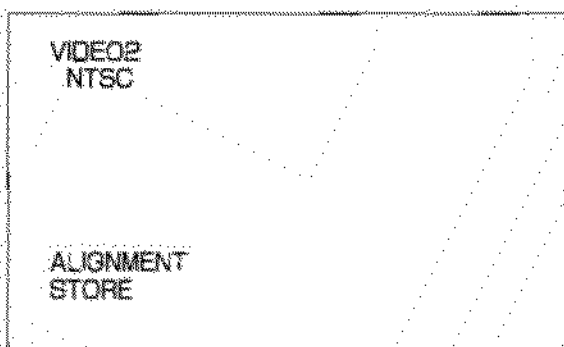

6. CONVERGENCE ADJUSTMENT

Adjust distortions such as linearity, pincushion, etc. which can not be corrected during ALIGNMENT adjustment. The green pattern is made the standard and thus you should first correct each green pattern distortion. Then correct the convergence of the other CRT's.

NOTE: Make sure that the image of the signal you want to adjust appears on the screen.



(1) Adjustment of Geometric Distortion for Green

- a. Display the crosshatch pattern by pressing the TEST key.
- b. Set to the convergence adjustment mode by pressing the CONV key.
- c. Display the green pattern only by pressing the R key and the B key.
- d. If you press the G key while pressing the CTL key, a display as shown below will appear.

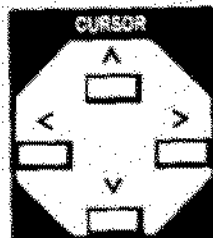
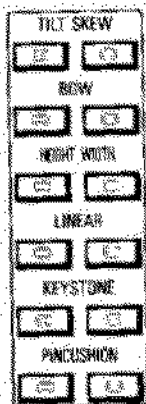
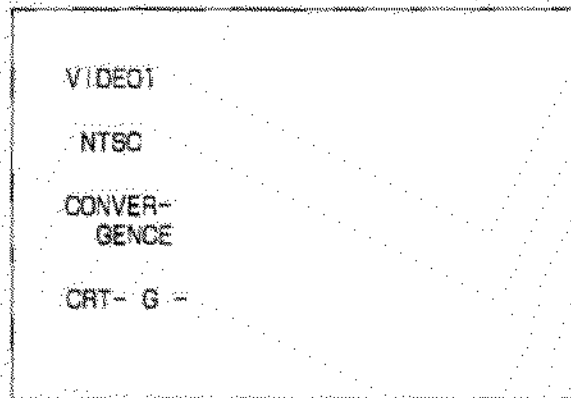

- e. Press to select one of the dynamic adjustment function keys.
- f. Adjust the green crosshatch pattern by pressing the cursor keys V, ^, < and >.

NOTE: Refer to p. 44 and 45 for each function.

(2) Red and Blue Convergence Adjustment

After having adjusted the geometric distortion for green, adjust the convergence for red and blue.

- Display the crosshatch pattern by pressing the TEST key.
- Set to the convergence adjustment mode by pressing the CONV key.

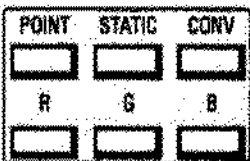
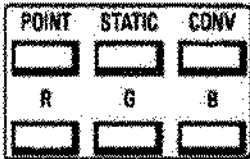
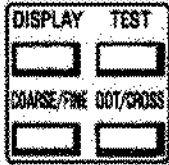

- Display only the standard G-CRT and the CRT you wish to adjust by operating the R, G and B keys.
- Select the CRT to be adjusted by pressing the R or B key while pressing the CTL key.
- Perform the static adjustment. (See below)
- Perform the dynamic adjustment. (See next page)
- Perform the point adjustment. (See page 46)

h. After adjustment has been completed, store the adjustment data by pressing the STORE key twice.

- Terminate the convergence adjustment mode by pressing the END key.

(3) Static Adjustment

- While in the convergence adjustment mode, press the STATIC key. A display as shown in the figure below will appear.

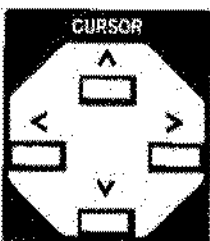
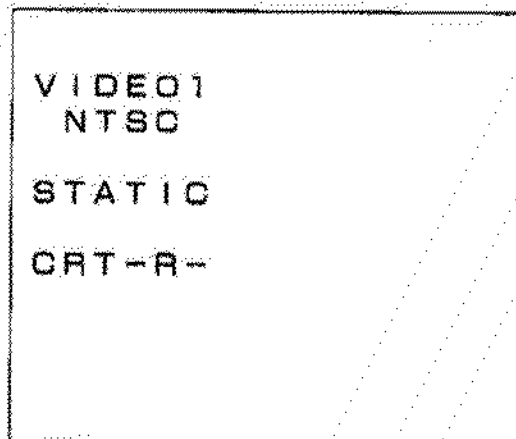

- Perform the adjustment using the cursor keys <, ^, v and > such that the center of the screen is lined up, using the green pattern as a reference.

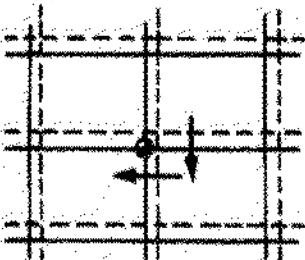

(4) Dynamic Adjustment

- a. Set to the convergence adjustment mode, then select each dynamic function.
- b. Perform the adjustment using the cursor keys <, ^, v and >.

NOTE: To adjust the convergence for KEYSTONE or PIN-CUSHION BALANCE, press the KEYSTONE keys or PINCUSHION keys while pressing the CTL key.

1. Dynamic TILT

Adjust Vertical to Center
Adjust Horizontal Right/Left Side

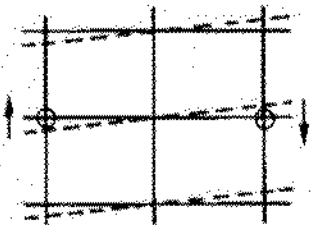

2. Dynamic V BOW

Adjust Vertical to Center
Adjust Horizontal Right/Left Side

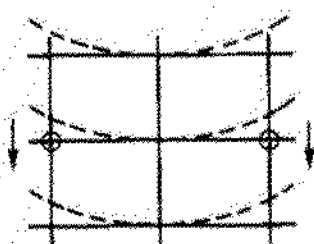

3. Dynamic V KEYSTONE

Adjust the 4 corners

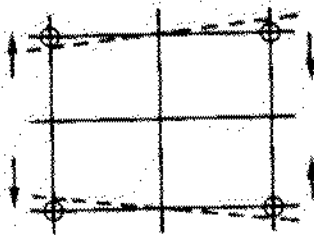

4. Dynamic V LINEAR

V Upper/Lower Side
H Center

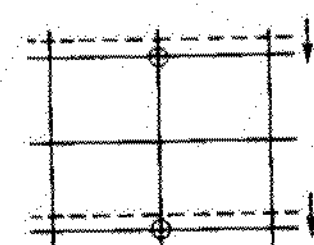

5. Dynamic HEIGHT

Adjust Vertical Upper/Lower Side
Adjust Horizontal to Center

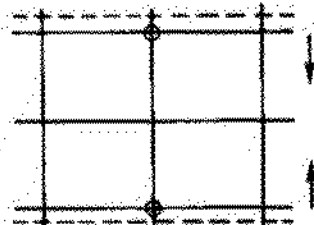

6. Dynamic TOP/BOTTOM PINCUSHION

Adjust the 4 corners

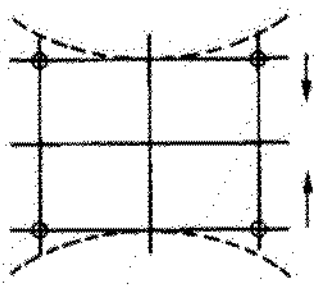

7. Dynamic SKEW

Adjust Vertical Upper/Lower Side
Adjust Horizontal to Center

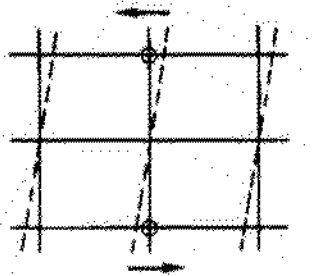

8. Dynamic H BOW

V Upper/Lower Side
H Center

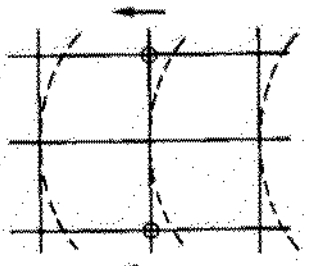

9. Dynamic H KEYSTONE

Adjust the 4 corners

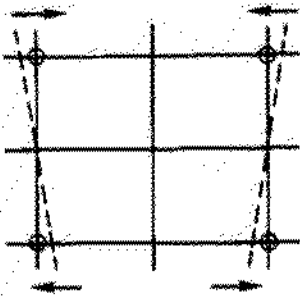

13. V KEYSTONE BALANCE

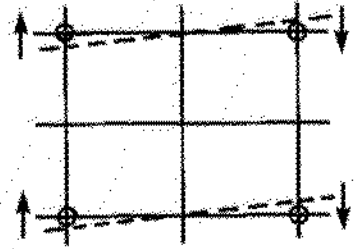

10. Dynamic H LINEAR

V Center

H Right, Left Side

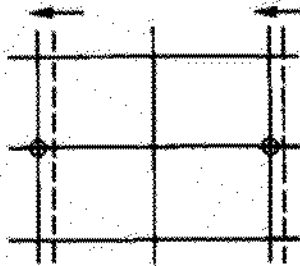

14. H KEYSTONE BALANCE

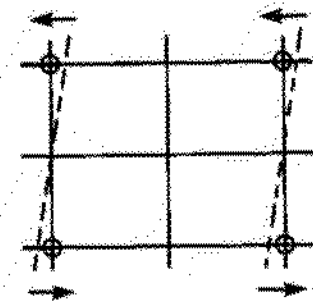

11. Dynamic WIDTH

V Center

H Right, Left Side

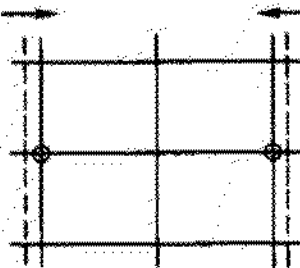

15. TOP/BOTTOM PINCUSHION BALANCE

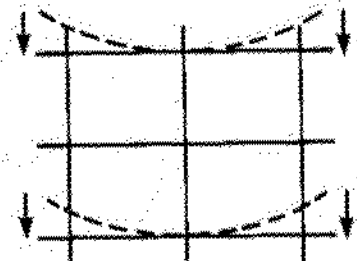

12. Dynamic SIDE PINCUSHION

Adjust the 4 corners

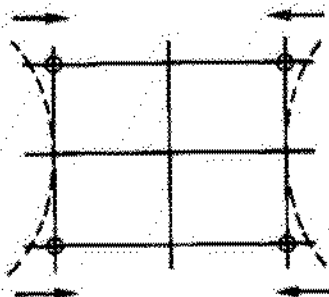

16. SIDE PINCUSHION BALANCE

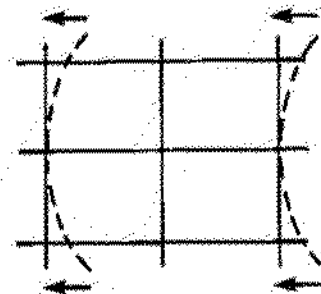

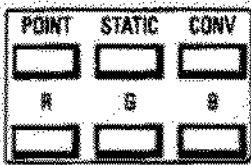

(5) Point Adjustment

- Press the POINT key while in the convergence mode.
- A display, as the one in the below figure, and the cursor will appear.
- Move the cursor to the spot to be adjusted using the cursor keys <, >, ^ and v.
- Adjust the cursor position by pressing the cursor key <, >, ^ and v while pressing the CTL key at the same time.

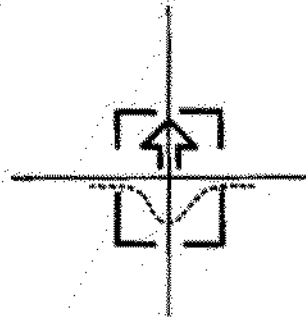
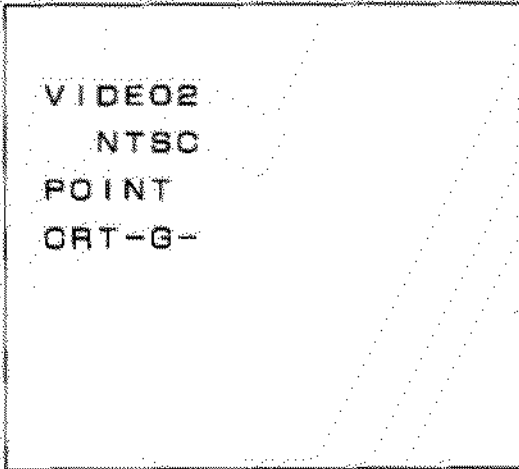

7. CONVERGENCE CANCEL FUNCTION

When the projector position must be changed, the screen size changed, the connection signal changed or the convergence substantially changed, cancel the convergence adjustment (to uncorrected condition) so that the convergence will not be over-corrected. Each input signal must be cancelled for each respective R, G and B CRT. After changing over to the signal you wish to cancel, display the test pattern by pressing the TEST key and select the CRT to be adjusted by pressing the R, G or B key while pressing the CTL key. Perform the below operation by pressing the CONV key.

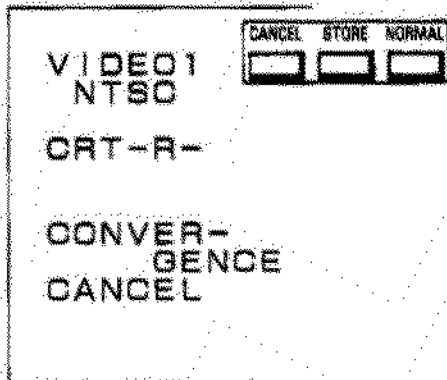

A. All data cancel (When all the convergence data is to be cancelled).

- Press the CANCEL key.
The "CANCEL" on-screen display will appear.
- Press the CANCEL key once more.
The "CANCEL" display will disappear and the convergence data will go into the floating condition.
- Press the STORE key.
The "STORE" on-screen display will appear.
- Press the STORE key once more.
The on-screen display will disappear, then the cancelled (clear) status will be stored.

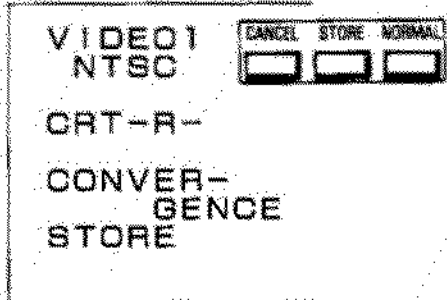

NOTE: You can return to the status before pressing the cancel key at any time prior to executing instruction (3). If you execute either of the following two instructions, it will return to the status prior to cancellation.

- Shut off power switch
- Press the CANCEL key twice while pressing the CTL key. "LOAD" will appear on the screen.

(5) Repeat steps (1)-(4) for each R, G and B CRT.



B. Dynamic cancel (When dynamic convergence data is to be cancelled)

- (1) Set to the adjustment mode by pressing the key for the item you wish to cancel from among the 12 dynamic adjustment keys.
- (2) Perform the same operations as (1) to (5) of part A.

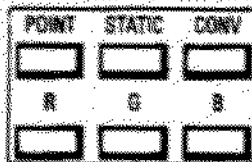
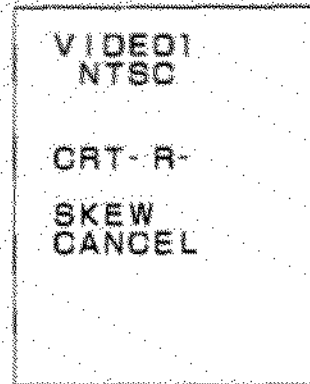

C. Static Cancel (When static convergence data is to be cancelled)

- (1) Set to the STATIC mode by pressing the STATIC key.
- (2) Perform the same operations as (1) to (5) of part A.

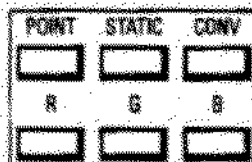
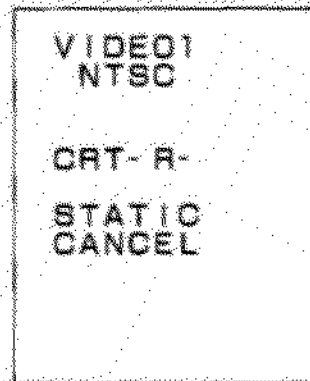

D. Point cancel (When point convergence data is to be cancelled)

- (1) Set to the point mode by pressing the POINT key.
- (2) Perform the same operations as (1) to (5) of part A.

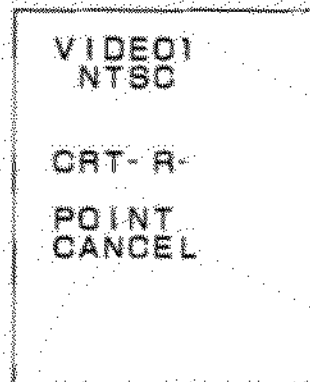

8. CONVERGENCE DATA COPY

If you have two or more input devices with similar signals (such as a VCR and a Video camera) you only need to completely adjust the convergence for the first input. Once it has been adjusted and stored, you can copy the convergence adjustments from the first input to any other similar input signal. To do this, follow the procedure outlined below.

(1) Change to the image signal you want to adjust.

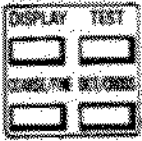

(2) Change to the test screen then display the copy screen by pressing the POINT key while pressing the CTL key.

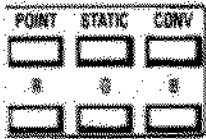

A list will be displayed on the screen with all of the signal names that have been recorded in the current INPUT LIST. Any non-recorded locations will be indicated with the characters "FREE." (See below)

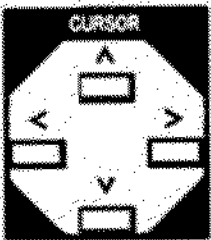

(3) Select the signal name to be copied by moving the cursor → using the cursor keys A and V.



(4) When the ENTER key is pressed, the convergence adjustment data for the input signal indicated by → is copied and output. It will then automatically return to the convergence adjustment mode. When FREE has been selected, the screen will not change.

(5) Complete the convergence adjustments at this point.



NOTE: To stop this mode, press the END key.

```

VIDEO1
NTSC
**** COPY LIST ****
00. VIDEO1 NTSC
01. VIDEO2 PAL
02. RGB1 CGA
03. RGB1 EGA
04. RGB1 VGA400
05. RGB1 VGA480
06. RGB2 IDC-1000
07. RGB3 MACII
08. FREE
09. FREE
10. FREE
11. FREE
    
```

9. PICTURE ADJUSTMENT

BRIGHT, CONTRAST, COLOR, TINT and SHARPNESS can be adjusted for each input. Store the set values after adjustment.

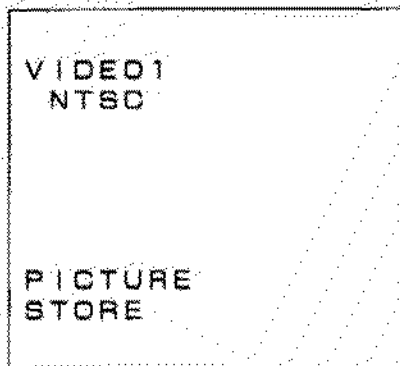
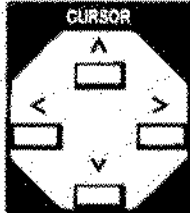
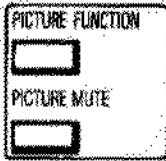
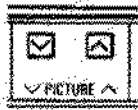

- (1) Select the picture adjustment mode using the PICTURE up or down buttons on the back of the projector or PICTURE FUNCTION key on the remote control.

- (2) The picture adjustment selected at that time and its level are displayed on the screen. (See below)
- (3) Adjust the level using the ADJUST button on the back of the projector or the cursor keys on the remote control. When Δ and $>$ are pressed the level increases; when ∇ and $<$ are pressed the level decreases.

NOTE: COLOR, TINT and SHARPNESS do not operate in the RGB mode. COLOR and SHARPNESS can be controlled only when NTSC, SECAM and PAL signals have been input. Also, TINT can be controlled only when NTSC is input.

- (4) Press the STORE key on the remote control.
 - a. "STORE" is displayed on the screen.
 - b. Press the STORE key again. "STORE" will disappear.
 - c. The picture adjustment level will be stored. (See figure on the left)

NOTE: Individually adjust the respective VIDEO 1, 2 and RGB 1, 2 and 3 signals. After having adjusted the picture, to return to the stored level (LOAD), press the CTL key while pressing the NORMAL key twice. To return the picture adjustments to their factory preset levels, press the NORMAL key twice.

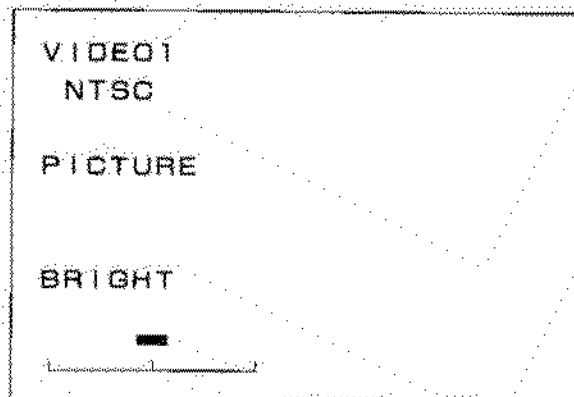

PART IV

INPUT SIGNAL RECORDING CHANGING RGB INPUT SIGNAL

1. INPUT SIGNAL ENTRY MODE METHOD

Signal entry

This projector uses a micro-processor to automatically read and distinguish several video signals input at the same time. These signals are then used to make optimum adjustments for focus, convergence, alignment, etc.

Various parameters must be recorded into the micro-processor beforehand to ensure the video signals are read correctly and adjusted to optimum quality.

The SIGNAL ENTRY MODE records these video signals in the INPUT LIST, and at the same time obtains the various parameters pertaining to these signals. Always access this mode first whenever inputting video signals for the first time so that you can record the video signals before making any adjustments.

1. Input List Mode

- (1) Display the MENU while the SOURCE display is showing by pressing the CTL and ENTER keys simultaneously.

```
INPUT LIST MODE
→ 1. INPUT LIST DISPLAY
   2. SIGNAL ENTRY
```

- (2) If you only want to review the INPUT LIST, select 1 with the cursor up/down keys, then press the ENTER key. Signals cannot be recorded at this display.

```
INPUT LIST
SC INPUT SOURCE COM
00 VIDEO1 NTSC - - -
01 VIDEO2 PAL - - -
02 RGB1 EGA - - -
```

- (3) Press the END key to return to the MENU display.

```
INPUT LIST MODE
1. INPUT LIST DISPLAY
→ 2. SIGNAL ENTRY
```

To record a signal for the first time, select 2 with the cursor up/down key, then press the ENTER key.

- (4) Press the END key to return to the MENU display.
- (5) Press the END key once more to terminate the INPUT LIST MODE.

2. Explanation of Screen Format

Each of the terms displayed on the screen of Fig. 1-2 is as follows. In the example of Fig. 1-2, the NTSC signal has already been recorded.

- "P1" The number of screen pages is displayed from P1 to P2.
12 signals can be recorded on each page for a possible total of 24.
- "SC" This area records the scan number. Scan numbers from 00 to 11 can be recorded. The scan number refers to the number allocated to the stored convergence data. Also, when you wish to input the same signal in VIDEO 1 and VIDEO 2, the same scan number can be recorded. You can also record more than one RGB 2, 3 signal.
- "INPUT" This area indicates the input terminal of the signal to be recorded. It is automatically displayed when INPUT 1-5 is used.
- "SOURCE" This area records the source name of the input signal.
- "COM" This area records the combination of input signals. This function is to reduce the number of times required to re-calculate these corrective waveforms when switching video signals.

NOTE: Refer to p. 58 for combination recordings.

Fig. 1-2

SIGNAL ENTRY			
P. 1			SI MODE
SC	INPUT	SOURCE	COM
00	VIDEO1	NTSC	---

3. Selection and Cancellation of the Recording Line

A two space underbar is displayed in the SC column as shown in Fig. 1-3. Move the underbar up and down using the up or down key on the remote control and select the line you wish to record. Then press ENTER.

NOTE: You cannot select a line that has already been recorded. When you wish to use a line that has already been recorded, cancel it, then delete the recorded signal. The cancel operation is as follows.

- (1) Move the underbar using the remote control up or down key to the position under the scan number to be cancelled.
- (2) Press the CANCEL key. The "CANCEL?" message will appear on the lower left corner of the screen. Press the CANCEL key again. The "CANCEL?" message will disappear and the cancel function will have been executed.

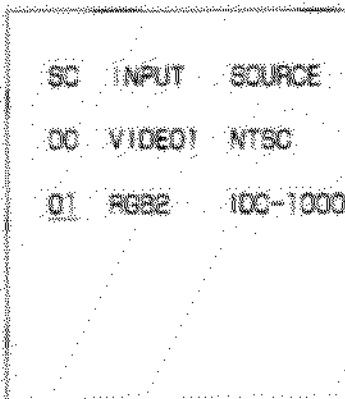
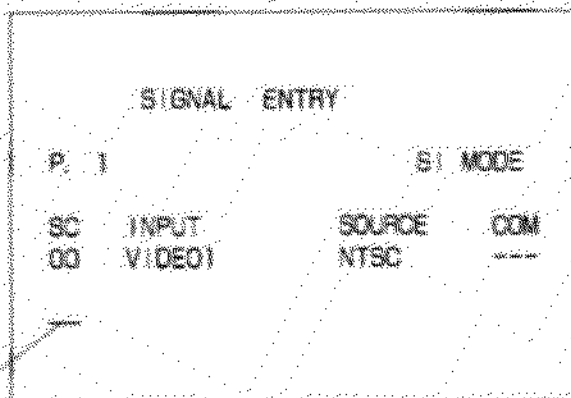
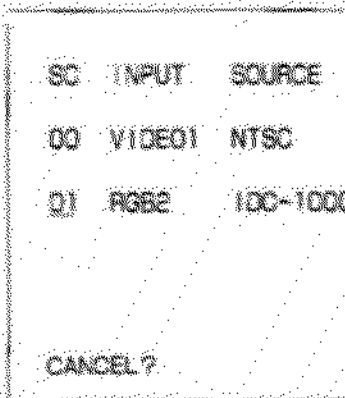
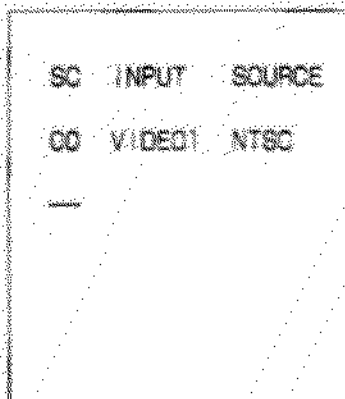

Fig. 1-3



Two digit underbar



* IDC-1000 is a registered trademark of NEC Corporation

4. Recording of Scan Number

When a one digit underbar is displayed in the SC column as shown in Fig. 1-4, select the scan number from 00 to 11 that you wish to record by using the up or down key on the remote control. Record it by pressing the ENTER key.

When the scan number has been recorded an 8 digit underbar will be displayed in the INPUT column.

(1) Display the scan number by pressing the cursor up or down key. Pressing \wedge key selects the scan number as follows:

00-11-10-09-----03-02-01-00

Pressing \vee key selects the scan number as follows:

00-01-02-03-----09-10-11-00

(2) Press the ENTER key to record the scan number.

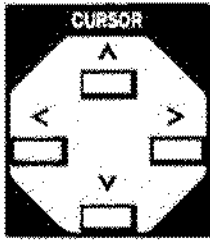

Fig. 1-4

SIGNAL		ENTRY	
P. 1		SI	MODE
SC	INPUT	SOURCE	COM
00	VIDEO1	NTSC	---

One digit underbar

Scanning number

The number in the SC column on the left side of the list indicates the SCANNING NUMBER. SCANNING NUMBERS range from 00 to 11 and represent the memory where the convergence data is stored. Since up to 24 different video signals can be recorded, several signals can use the same scanning number to enable convergence data sharing.

SC	INPUT	SOURCE	COM
00	VIDEO1	NTSC1	- - -
01	VIDEO2	PAL	- - -
00	VIDEO2	NTSC2	- - -
02	RGB2	PC1	- - -
03	RGB2	PC2	- - -
03	RGB3	PC3	- - -

The example above shows scanning number 00 being used for both inputs VIDEO 1 and VIDEO 2 so that they can receive NTSC signals. PC2 of RGB2 and PC3 of RGB3 also use the same scanning number, 03.

The NTSC signal is a standardized video signal. This means you can share convergence correction data because the H-width and V height frequencies, as well as the display amplitude are all regulated. Personal computers, on the other hand, do not have common standards for output video signals. Sharing convergence correction data would thus require similar H-width, V-height, and display amplitudes. The advantages in sharing convergence correction data are that you can use the storage area efficiently and cut down on adjustment time. For devices that both share the same data, this means that you can switch video signals without having to calculate convergence correction waveforms, thus making the switch instantaneous. This also means that the H-width and V-height for convergence and alignment cannot be adjusted individually. Nevertheless, focus, picture, and alignment adjustments can be made individually to achieve the optimum adjustment.

5. Recording of the Input Signal Terminal

Fig. 1-5

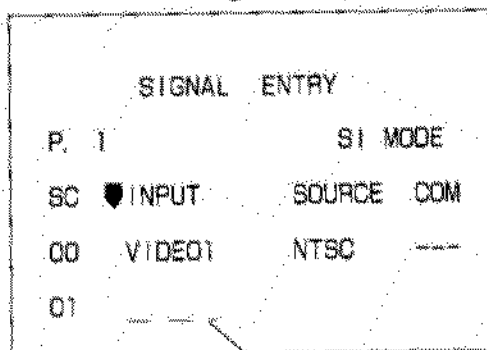

Eight-digit underbar

When the 8 digit underbar is displayed in the INPUT column as shown in Fig. 1-5, match it to the projector setting condition on the below Table 1-1, then press the corresponding INPUT keys 1-5. The input recording is performed in this manner. For example: To select RGB 2, press INPUT 4 on the remote control. After input recording has been completed, the name of the input terminal will be displayed in the INPUT column. Also, an 8 digit underbar will be displayed in the SOURCE column.

Table 1-1

When SI Connected		When Projector Only	
INPUT 1	VIDEO-1	INPUT 1	VIDEO
INPUT 2	VIDEO-2	INPUT 2	RGB
INPUT 3	RGB-1		
INPUT 4	RGB-2		
INPUT 5	RGB-3		

NOTE: After pressing the INPUT key, the vertical synchronization may be disturbed. If this happens, adjust it by using the V-HOLD key. Following V-HOLD adjustment, press the END key to return to the recording screen.

6. Recording of the User Source Name

When the ENTER key is pressed, the underbar in the SOURCE column will change to a single digit. Input the source name by selecting one character at a time with the INPUT keys 1-9 and moving the cursor with the right (>) or left (<) key. For example: To select the letter A, press the INPUT 1 key once, to select the letter B, press it twice and to select the letter C, press it three times. When finished, press the ENTER key. After recording the source name, there will be a delay for inputting combinations. (See Fig. 1-7 on the following page.)

Fig. 1-6

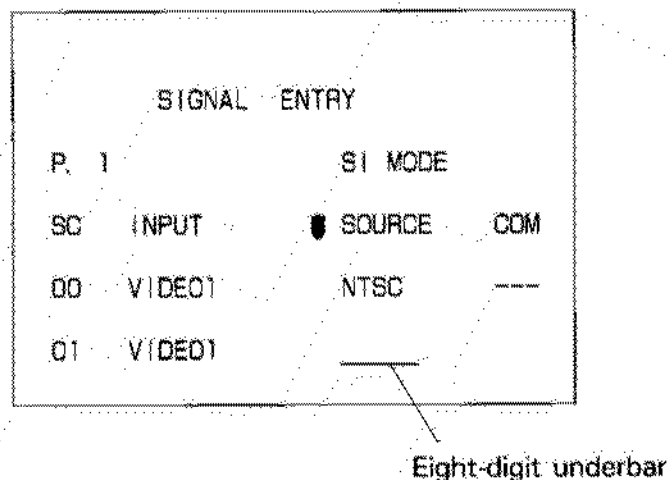

7. Recording of Combinations

Fig. 1-7

SIGNAL ENTRY			
P. 1		SI MODE	
SC INPUT		SOURCE	COM
00 VIDEO1		PAL-SOM	---
01 VIDEO1		NTSC	---

Move the cursor (underline) using the right (>) and left (<) keys. When the ENTER key is pressed, the number 1, 2 or 3 will be displayed and recorded. Display the priority sequence 1, 2 and 3. To cancel a combination, move the cursor to the position to be cancelled and press the CANCEL key once.

Video signal switching takes a certain amount of time to accomplish due to the task of re-outputting adjustment data and re-calculating convergence correction waveforms. This device has an increased memory capacity that allows you to store several different convergence correction waveforms at the same time, therefore reducing the number of times required to re-calculate these corrective waveforms when switching video signals. Two functions have also been provided to take advantage of this hardware.

History function

The history function keeps track of the video signals you can switch to by storing them into the output memory, arranged according to how often that signal is used. Video signals for most personal computers will usually require only four scans of data. Under normal switching requirements, the history function should be all you need for smooth switching.

Combination function

Some personal computers have several video signal outputs per one machine and may be running software that switches these signals quite often.

If you are using this kind of personal computer as your signal source, the history function should suffice. However, if you want to connect two or more computers to the System Interface, the history function may not work properly.

Instead, you can use the combination function to specify a combination of video signal data, and store that combination in memory.

SC INPUT	SOURCE	COM
00 VIDEO1	NTSC1	---
01 VIDEO2	PAL	---
00 VIDEO2	NTSC2	---
02 RGB1	CGA	1 - -
03 RGB1	EGA	1 - -
04 RGB2	VGA1	- 2 -
05 RGB2	VGA2	- 2 -
06 RGB2	VGA3	- 2 -

The previous example shows how the combination function is used with the RGB1 and RGB2 signals. The figures displayed in the COM column on the right side indicate the order of priority. Under this condition, when the signals are switched to RGB1 CGA, the corrective waveforms for RGB1 EGA are also calculated and stored in memory to prepare for a fast signal switch. Whenever either VGA1, VGA2, or VGA3 of RGB2 is selected, the remaining two signals are also calculated and stored in memory.

Combinations can be specified more than once to a single signal. The example below shows two specifications for RGB1 VGA1. Whenever RGB1 VGA1 is selected, the combination of CGA and EGA (which are higher in priority) are also stored in memory.

SC	INPUT	SOURCE	COM
00	VIDEO1	NTSC1	- - -
01	VIDEO2	PAL	- - -
00	VIDEO2	NTSC2	- - -
02	RGB1	CGA	1 - -
03	RGB1	EGA	1 - -
04	RGB1	VGA1	1 2 -
05	RGB1	VGA2	- 2 -
06	RGB1	VGA3	- 2 -

Combinations can be registered up to the three times. Keep this number to a minimum, however, as too many specifications may hinder the effectiveness of the combination.

8. Completion of Signal Recording

Press the END key to complete the recording. To record another input, return to step 3.

To terminate this mode, press the END key again. Select 2. SIGNAL ENTRY from the on-screen menu and press END to return to the source screen.



INPUT LIST MODE

1. INPUT LIST
- 2. SIGNAL ENTRY



9. Input Signal Recording at the Time of Factory Shipment

INPUT LIST			
SC	INPUT	SOURCE	COM
00	VIDEO1	NTSC	_____
01	VIDEO2	PAL	_____
02	RGB1	CGA	_____
03	RGB1	EGA	_____
04	RGB1	PGA400	_____
05	RGB1	PGA480	_____
06	RGB2	IDC-1000	_____
07	RGB3	MACII	_____

MAC II is a registered trademark of Apple Computer Inc.

Figure 1-8

The input signals are recorded at the factory as shown in Fig. 1-8.

2. CHANGING THE RGB INPUT SIGNAL

When the Projector is shipped from the factory, RGB 1 is adjusted to accept *IBM PC/AT and RGB 2, 3 will accept RGB 2, 3 signal input as in the table on page 64. If inputting a different signal, it is necessary to adjust in the following order.

(1) To Change RGB 2, 3 Input Signal RGB 2, 3 Preset Signal

The RGB 2, 3 inputs have been adjusted at the factory to receive the signals as in the table on page 64. If different signals are used, follow the steps outlined below.

1. Cancel the recorded signal. (See page 54. "Cancellation of the Recording Line")

2. R GAIN, G GAIN, B GAIN (Only connected to System Interface)

- a) Press the PICTURE FUNCTION key while pressing the CTL key to select the desired color again and light R, G or B GAIN indicator on the System Interface. The "R, G or B GAIN" message will be displayed on the screen.

NOTE: You must have a picture displayed on the screen—not the test pattern.

b) Connect an oscilloscope to selected color TEST point R-GAIN (TP607), G-GAIN (TP608), and B-GAIN (TP609).

c) Adjust the remote control cursor keys to obtain a value of 1.4 Vp-p on the oscilloscope.

NOTE: Since the R, G and B GAIN are set at the optimal condition at the time of shipment, adjustment is normally unnecessary.

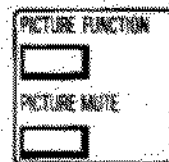
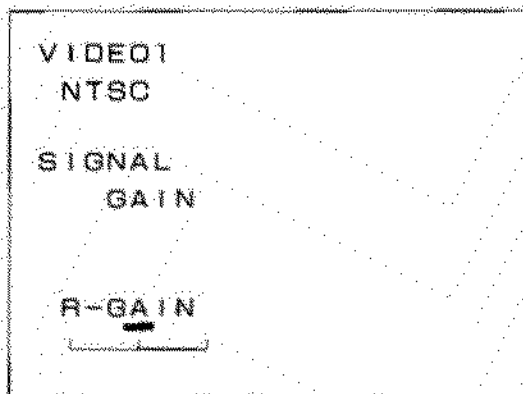

3. H POSITION (Phase Adjustment)

a) Press the H POSITION key to display "H POSITION" on the screen.

b) Press the remote control cursor keys to position the picture in the center of the screen.

4. H WIDTH, V HEIGHT (Amplitude Adjustment)

a) Press the H WIDTH key to display "H WIDTH" on the screen.

b) Press the remote control cursor keys to obtain a scan of 95% in proportion to the screen.

c) In the same manner, adjust the V HEIGHT.

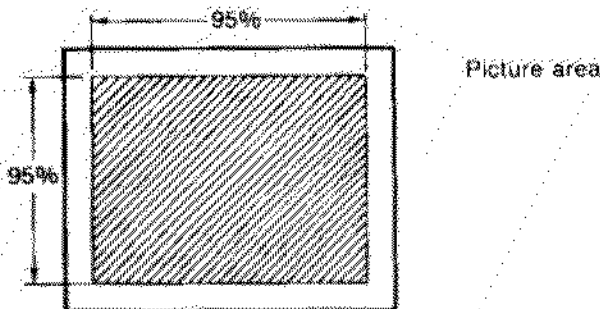

5. V HOLD (Vertical Sync Fine Adjustment)

- a) Press the V HOLD key to display "V HOLD" on the screen.
- b) Press the remote control cursor keys to obtain a picture without pairing.

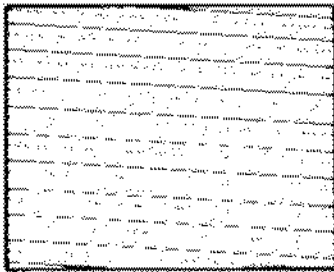

Normal Condition

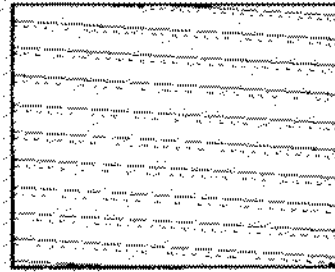

Pairing Occurs

NOTE: Store the adjustment data in the memory by pressing the STORE key twice after the above adjustments have been completed.

6. Convergence Focus Adjustment

- a) Carry out convergence and focus.

(2) To Change RGB 1 Input from *IBM PC/AT to *PS-2

- 1. Set No. 1 pin of DIP switch on the rear panel of the System Interface to OFF to select PS-2 mode.
- 2. Connect the input signal as shown on page 10. There are 4 modes for *IBM PS-2 as in table 1, therefore, carry out the adjustment for each mode.
Adjust using the same procedures as in (1), steps 1-6 above.

Sync. Polarity		VGA Mode
H	V	
Positive	Negative	350 line
Negative	Positive	400 line
Negative	Negative	480 line
Posetive	Posetive	8514 A

Table 1

PART V

**CHARTS
REFERENCE TABLES
TROUBLESHOOTING**

TIMING CHARTS

Separate Sync.

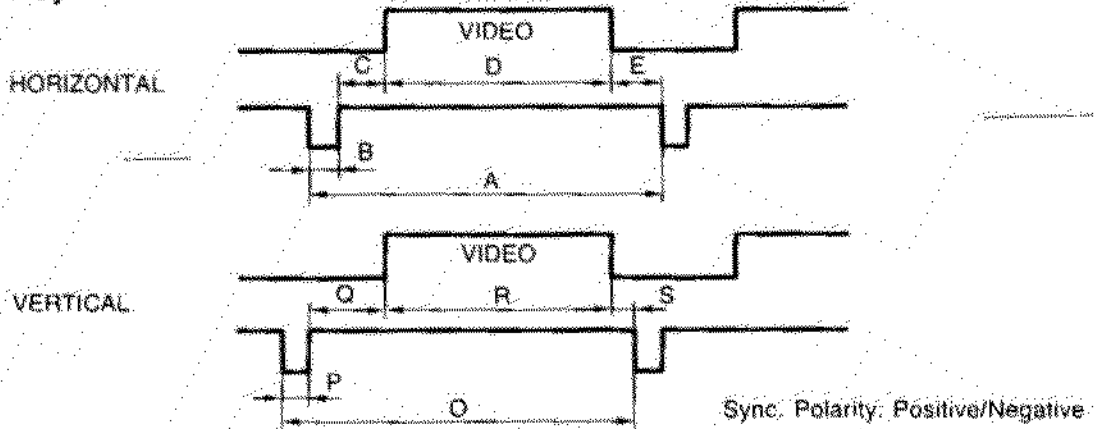

		RGB 1 SIGNAL				RGB 2 SIGNAL	RGB 3 SIGNAL
		* IBM CGA	* IBM EGA	* IBM PGA 400Line MODE	* IBM PGA 480Line MODE	IDC-1000	** MAC II
Horizontal	A _{μs}	63	45.5	33	33	31.78	28.57
	B _{μs}	4.2	4.9	4.5	4.5	2.76	2.12
	C _{μs}	7.2	1.6	2.8	2.8	1.6	3.17
	D _{μs}	45	39	25.6	25.6	26.29	21.16
	E _{μs}	6.6	0	0.1	0.1	1.13	2.12
Vertical	Oms	16.4	16.68	16.6	16.6	16.67	15
	Pms	0.076	0.6	0.07	0.07	0.64	0.09
	Qms	1.525	0.08	2.12	0.83	0.77	1.11
	Rms	12.6	16	13.05	15.67	15.14	13.71
	Sms	2.2	0	1.36	0.03	0.12	0.09

IBM PS-2 TIMING CHARTS

		350 Line MODE 31.47kHz	400 Line MODE 31.47kHz	480 Line MODE 31.47kHz	8514A MODE 35.52kHz
		Horizontal	A _{μs}	31.8	31.8
	B _{μs}	3.8	3.8	3.8	3.9
	C _{μs}	1.6	1.6	1.6	1.3
	D _{μs}	26.1	26.1	26.1	22.8
	E _{μs}	0.3	0.3	0.3	0.2
	Sync polarity	+	-	-	+
Vertical	Oms	14.3	14.3	16.7	11.5
	Pms	0.06	0.08	0.06	0.11
	Qms	1.72	0.89	0.79	0.56/0.58*
	Rms	11.53	13.19	15.79	10.81
	Sms	0.99	0.16	0.06	0.02/0"
		Sync polarity	-	+	-

* Interface

TIMING CHARTS EXAMPLE

(a) Separate Sync.

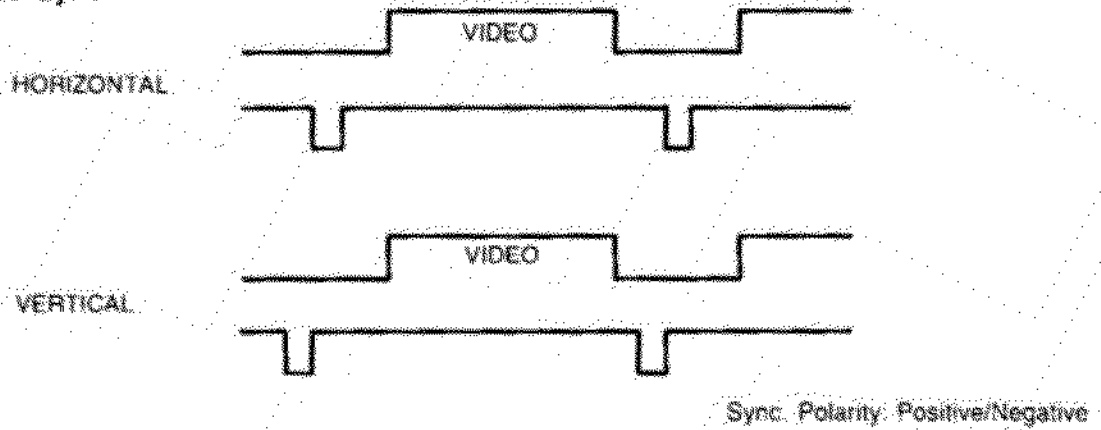

(b) Composite Sync.

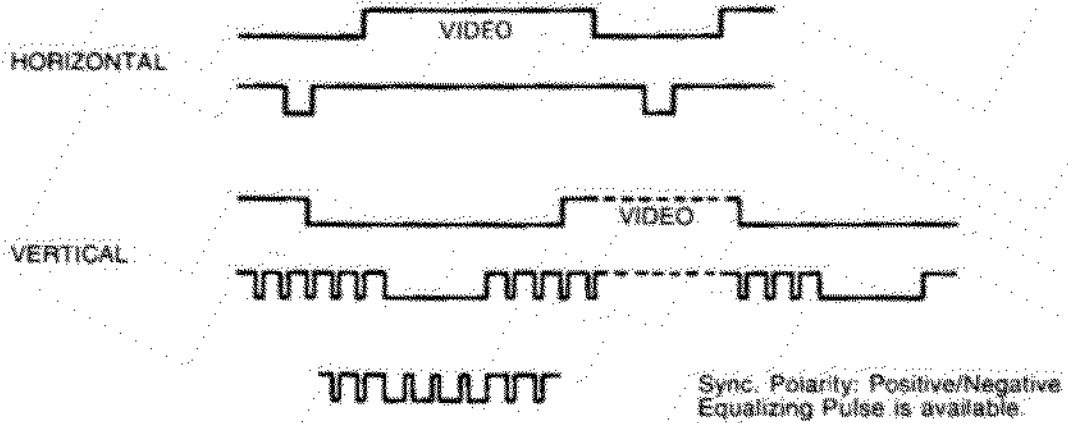

(c) Composite Sync. & Video (Sync. on Green)

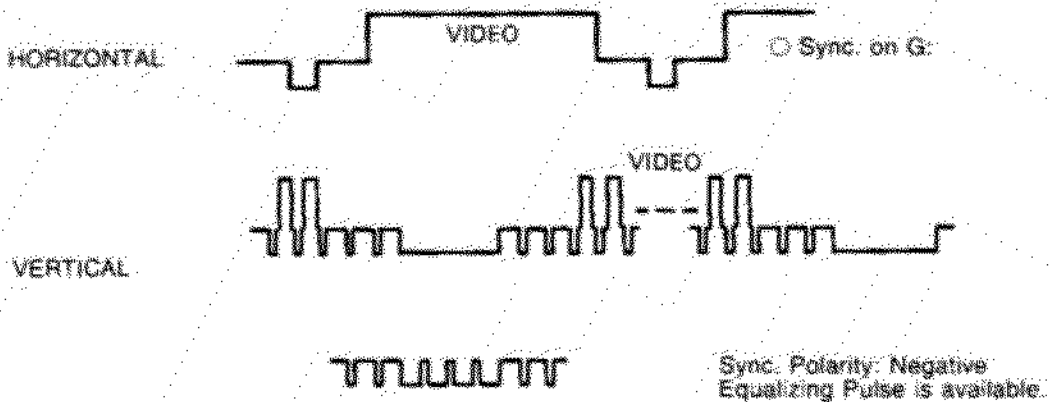

TROUBLESHOOTING

Problem	Check/Solution
<p>No power</p>	<ul style="list-style-type: none"> • Is the projector plugged into an active AC outlet and the power switch ON? • Is the STAND-BY indicator on the projector lighted? If it goes on and off, make sure that the System Interface and the remote cable are securely connected. • Is the System Interface plugged into an active AC outlet and the power switch ON? • Is the POWER indicator on the System Interface lighted? • Is the remote cord between the System Interface and projector connected and properly secured? (page 36) • Is the remote control unit plugged in (wired) and the power button ON? • Is the remote control unit (wireless) within the effective operating distance when the power-button is pressed? (page 37)
<p>No picture</p>	<ul style="list-style-type: none"> • Are the R, G, B, H and V leads correctly connected between the System Interface output terminals and the projector input terminals? (page 10) • Is the correct video or RGB input selected? • Is the external component properly connected? (page 10) • Is the external component plugged into an active AC outlet and power ON? • If using an *IBM personal computer, is the TTL, ANALOG switch in the correct position? • Is the test mode selected without any beam turned ON? • Is BEAM "OFF" selected on the external control?
<p>Picture is not clear</p>	<ul style="list-style-type: none"> • After inputting a new signal, carry out electrical focus adjustments. • Is the installation of the projector set correctly? • Is level of a signal normal? Be sure to adjust the RGB gain control of the System Interface to obtain a value of 0.7Vp-p. • Is adjusting convergence correct?
<p>No color</p>	<ul style="list-style-type: none"> • Is the correct system button on the System Interface depressed? • If using an *IBM computer, confirm the correct setting of the TEXT button and the DIP switch on the System Interface
<p>Picture is inverted left or right direction reversed</p>	<ul style="list-style-type: none"> • Check the setting of the Horizontal and Vertical polarity plugs. Refer to the Table on page 30.

Problem	Check/Solution
Color unusual	<ul style="list-style-type: none"> • Are the R, G, B, H and V leads correctly connected between the System Interface output terminals and the projector input terminals? (page 10) • Are the controls in the control compartment of the System Interface correctly set for the R, G, B input signal? • If not using an IBM computer confirm that the signal is compatible.
No operation from remote control	<ul style="list-style-type: none"> • Is the wired remote control plugged into the System Interface or the projector? • If using the remote control unit as the wireless confirm you are within the effective operating range see page 37. • Is the remote lead between the System Interface and the video projector connected correctly? (page 10) • Is the EXT CONTROL/Remote switch on the rear panel of the System Interface in the correct position?

INDUSTRIAL VIDEO PRODUCTS
LIMITED WARRANTY
PROFESSIONAL RECEIVER AND MONITORS

NEC Technologies, Inc. (hereafter NECTECH) warrants this product to be free from defects in material and workmanship under the following terms:

HOW LONG IS THE WARRANTY

Labor is warranted for (6) Six Months from the date of the first consumer purchase. Parts are warranted for (1) One Year from the date of the first consumer purchase, with the exception of the pick-up device (Image Sensor) which is warranted for (90) Days.

WHO IS PROTECTED

This warranty may be enforced only by the first consumer purchaser.

WHAT IS COVERED AND WHAT IS NOT COVERED

Except as specified below, this warranty covers all defects in material or workmanship in this product. The following are not covered by the warranty:

1. Any product which is not distributed in the U.S.A. by NECTECH or which is not purchased in the U.S.A. from an authorized NECTECH dealer. Authorized NECTECH dealers can be identified by an NECTECH window decal. Any dealer which does not display this decal may be an unauthorized dealer. If you are uncertain as to whether a dealer is authorized, please contact NECTECH at (708) 860-0335.
2. Any product on which the serial number has been defaced, modified or removed.
3. Damage, deterioration or malfunction resulting from:
 - a. Accident, misuse, abuse, neglect, fire, water, lightning or other acts of nature, commercial or industrial use, unauthorized product modification, or failure to follow instructions supplied with the product.
 - b. Repair or attempted repair by anyone not authorized by NECTECH.
 - c. Any shipment of the product (claims must be presented to the carrier).
 - d. Removal or installation of the product.
 - e. Any other cause which does not relate to a product defect.
 - f. Burns or residual images upon the phosphor of the tubes.
 - g. Damage to the writing board caused by improper markers/cleaners.
4. Carbons, carrying cases, batteries, external cabinets, magnetic tapes, or any accessories used in connection with the product.

WHAT WE WILL PAY FOR AND WHAT WE WILL NOT PAY FOR

We will pay labor and material expenses for covered items, but we will not pay for the following:

1. Removal or installation charges.
2. Costs of initial technical adjustments (set up), including adjustment of user controls. These costs are the responsibility of the NECTECH dealer from whom the product was purchased.
3. Payment of shipping charges.

REGIONAL SERVICE FACILITIES:

NEC Technologies, Inc.
1255 Michael Drive
Wood Dale, Illinois 60191
(708) 860-9230

NEC Technologies, Inc.
373 E. Route 46 West
Fairfield, New Jersey 07008
(201) 882 9008

NEC Technologies, Inc.
4947 W. Rosecrans
Lawton, California 95060
12/31/9/8-1805

NEC Technologies, Inc.
4335 Cambridge Road
Fort Worth, Texas 76155
(817) 267 6191

HOW YOU CAN GET WARRANTY SERVICE

1. If you have purchased a 19" or larger monitor or a projection television, service will be rendered at the location of the product. Mediabus also have service rendered at the location of the product.
2. To obtain service on your product, you must take or ship it prepaid to any authorized NECTECH service center.
3. Whenever warranty service is required, the original dated sales slip (or a copy) must be presented as proof of warranty coverage, and should be included in any shipment of the product. Please also include in any mailing, your name, address, and a description of the problem(s).
4. For the name of the nearest NECTECH authorized service center, contact your dealer or NECTECH.

LIMITATION OF IMPLIED WARRANTIES

ALL IMPLIED WARRANTIES, INCLUDING WARRANTIES OF MERCHANTABILITY AND FITNESS FOR A PARTICULAR PURPOSE, ARE LIMITED IN DURATION TO THE LENGTH OF THIS WARRANTY.

EXCLUSION OF DAMAGES

NECTECH'S LIABILITY FOR ANY DEFECTIVE PRODUCT IS LIMITED TO THE REPAIR OR REPLACEMENT OF THE PRODUCT AT OUR OPTION. NECTECH SHALL NOT BE LIABLE FOR:

1. DAMAGE TO OTHER PROPERTY CAUSED BY ANY DEFECTS IN THIS PRODUCT, DAMAGES BASED UPON INCONVENIENCE, LOSS OF USE OF THE PRODUCT, LOSS OF TIME, COMMERCIAL LOSS, OR
2. ANY OTHER DAMAGES, WHETHER INCIDENTAL, CONSEQUENTIAL OR OTHERWISE.

SOME STATES DO NOT ALLOW LIMITATIONS ON HOW LONG AN IMPLIED WARRANTY LASTS AND/OR DO NOT ALLOW THE EXCLUSION OR LIMITATION OF INCIDENTAL OR CONSEQUENTIAL DAMAGES, SO THE ABOVE LIMITATIONS AND EXCLUSIONS MAY NOT APPLY TO YOU.

HOW STATE LAW RELATES TO THE WARRANTY

This warranty gives you specific legal rights, and you may also have other rights which vary from state to state.

TO HAVE YOUR PRODUCT SERVICED:

TELEPHONE: 708-860-9230

FOR ALL OTHER INFORMATION

TELEPHONE: 708-860-0335

NOTE: All products returned to NECTECH for service MUST have prior approval. This may be obtained by calling the number above.

1-800-849-4088

Maria Cotton
X-130

Eldon Carl
Cart. Inc.

X-130