

54-7068-01P

Issue #	Issue Date	RFC#	Apprv. Date	Description	Approved By...	
					Design Eng.	Design Val'n.
01	5-5-97	N/A	05-2-97	Original	<i>Gary Waldeck</i>	<i>Barry Robinson</i>

PRODUCTION NOTES

Use attached pages as masters for double-sided copies.

ECP[®] 3500 PLUS

User's Manual

54-7068-01P

WARNING

To reduce the risk of fire or electrical shock, do not expose the projector to rain or moisture. Observe and follow all warnings and instructions marked on the projector.



The exclamation point within the equilateral triangle is intended to alert the user to the presence of important operating and maintenance (servicing) instructions in the literature accompanying the projector.



The lightning flash with arrowhead symbol, within the equilateral triangle is intended to alert the user to the presence of uninsulated "dangerous voltage" within the projector's enclosure that may be of sufficient magnitude to constitute a risk of electric shock to persons.

Before operating the projector for the first time, read section 4.1 Warnings and Guidelines.

NOTICE

The projector generates and may radiate radio frequency energy. If not installed and used in accordance with this manual, it may cause interference with radio communications.

The projector is tested to and complies with the limits for a Class A computing device pursuant to subpart J of part 15 of FCC rules, which are designed to provide reasonable protection against radio interference in a commercial environment. When the projector is operated in a residential area it may cause radio interference. In such a case the user will be required, at his/her own expense, to take measures required to correct the interference.

The projector is tested to and complies with the limits for a Class A digital apparatus pursuant to the Canadian Department of Communications radio interference regulations. The regulations are designed to provide reasonable protection against such interference from devices operated in a commercial environment.

Cet appareil à affichage numérique a été contrôlé. Il est conforme aux limites des règlements de la Classe A d'appareils à affichage numérique établis par le Ministère des Communications du Canada en ce qui concerne les interférences radio. Ces règlements ont été mis en place pour assurer une protection raisonnable contre les interférences produits par des appareils utilisés dans un environnement commercial.

CAUTION

Only use attachments or accessories recommended by Electrohome. Use of others may result in the risk of fire, shock or personal injury, and may void the warranty.

Typographical Conventions

Please note the following typographical conventions used throughout this manual.

- Warnings that relate to user safety are highlighted in **bold** print.
- First and second level subsection titles are located in the left margin of each page. Third level titles are located within the body text and are in ***bold italic*** print.
- The pointing hand symbol  emphasizes important information within a subsection or paragraph.
- Special notes and comments appear in *italics*. Important terms within a paragraph appear in *italics*.

PROJECTION SYSTEMS LIMITED WARRANTY POLICY

WARRANTY

Electrohome Projection Products are warranted to be free of defects in material and workmanship in normal use for the period listed below from the original date of purchase:

PRODUCT	PART	PICTURE TUBES	LABOUR
Color Projection Monitor	1 Year	1 Year	1 Year
Interface Devices	1 Year replacement warranty		1 Year
Wire Harness	90 Day replacement warranty		
Accessories (stands, screens, etc.)	90 Day replacement warranty		

This warranty does not apply to units which have been subject to abuse, accident, improper installation or on which the serial number has been removed or damaged.

1. LIMITATIONS

1. The labour warranty is valid only if the malfunctioning unit is returned prepaid to an authorized service depot or selling dealer. It does not cover "on location" service.
2. The warranty does not cover:
 - a) Problems caused by associated equipment such as antenna distribution systems, video tape recorders, cameras, etc.
 - b) Damage caused by accident, misuse, improper power source, fire, flood, lighting, other acts of God, repair or alteration by other than Electrohome Limited authorized service organization.
 - c) Transit damage.
 - d) Phosphor degradation of the picture tube: example, visible burns or patterns on phosphor screen during normal use.
3. Proof of purchase is necessary for verification of warranty.
4. Unit must be properly packaged (in original packaging if possible) when returned under warranty.
5. Electrohome Interface devices are designed to be used with Electrohome projection systems. Use of other interface devices with Electrohome projection systems could void the warranty. Interfaces used with other than Electrohome projection systems are void of all warranty.
6. Wire harness assemblies sold by Electrohome contain installation instructions. These instructions are current at the time of printing and updated as necessary. Although Electrohome strives to maintain our technical information as current as possible, we cannot be responsible for changes made by the terminal manufacturer to their specs and equipment as it applies to the installation of the wiring harness or its operation. Wire harness should be installed by qualified technical personnel.

2. DEALER'S OBLIGATION

1. The dealer is expected to evaluate the merchandise to insure that it is in working order, and is responsible for making any minor setup adjustments at no cost to Electrohome or the customer.
2. The dealer must advise the customer that the warranty registration card is to be filled out and mailed to Electrohome within 7 days of the date of purchase using the return envelope provided.
3. If assistance or guidance is required on technical problems, it is the dealer's responsibility to contact Electrohome Limited, or the nearest authorized service depot.
4. Where warranty service is required, it is the dealer's responsibility to insure that the unit is packed and shipped prepaid to an authorized Electrohome Limited service depot.
5. If a dealer elects to make warranty repairs through anyone other than an authorized Electrohome Service depot, the warranty becomes void, unless otherwise specified.
6. A current list of all authorized serviced organizations can be obtained from Electrohome Limited. In the United States, call 1-800-265-2171. In Canada, call (519) 744-7111.

7. When returning a unit for repair to an authorized service depot, documentation should be included with the following information.

In Warranty

- A. Customer's name and address.
- B. Date of Purchase.
- C. Specific complaint/failure (Notations such as "defective" or "repair under warranty" are not acceptable).

Out of Warranty

- A. Include terms A, B, C, of "In Warranty".
- B. A purchase Order to cover the cost of repairs.

Damaged Merchandise

See transit damage/loss below.

3. TRANSIT DAMAGE/LOSS

VISIBLE/HIDDEN DAMAGE

Electrohome Limited endeavours to use reliable and reputable carriers but occasionally damage or loss can occur. Resolving the problem of transit damage or loss depends on the co-operation of all parties. The following will outline the responsibilities of the various parties involved.

The consignee or buyer must:

- Inspect all shipments on arrival.
- If damage, suspected damage or loss is apparent upon delivery, an appropriate notation should be marked on all copies of the carrier's pro bill and the driver **must** sign all copies to acknowledge this notation.
- Ask the carrier to do a detailed inspection of the damages.
- File a claim with the carrier.
- Co-operate with the carrier to achieve damage repair where possible.
- Follow-up as necessary to secure final settlement.

The carrier should:

- Co-operate in every way with the buyer/claimant to achieve an amicable settlement.

Electrohome will:

- **Assist** our customers, through our Distribution Services Department, in freight claim matters.
- **Drop Shipments:** Electrohome does not promote the practice of drop shipments.
- Although Electrohome will provide every assistance, we cannot be responsible for the actual filing of claims on the carrier or accept liability for uncontrolled freight claims.

4. SERVICE DEALER

Dealers who maintain their own service facilities and would like to become an authorized depot may acquire application forms from Electrohome Limited.

Table of Contents

1	Introduction	1.1	The Projector	1-1
		1.2	Purchaser's Record and Servicing	1-2
2	Installation & Setup	2.1	Quick Setup	2-1
		2.2	Installation Considerations	2-2
		2.3	Keypad Battery Installation	2-8
		2.4	Mounting	2-8
		2.5	Power Connection	2-11
		2.6	Source Connections	2-12
		2.7	Serial Port Connections	2-13
		2.8	Memory Setup	2-16
		2.9	ACON Setup	2-21
3	Operation	3.1	Overview	3-1
		3.2	Projector Basics	3-1
		3.3	Source Selection	3-10
		3.4	Setup Memories	3-13
		3.5	Display Adjustments	3-16
		3.6	Convergence Registration	3-21
		3.7	Utility Features	3-28
		3.8	Multi-projector Functions	3-36
4	Maintenance	4.1	Warnings and Guidelines	4-1
		4.2	Cleaning	4-3
		4.3	Troubleshooting	4-3
5	Specifications	5.1	Specifications	5-1
	Appendices	A	Glossary	A-1
		B	Throw Distance Tables	B-1
		C	ASR Reference	C-1
		D	Communication Cables	D-1
		E	Keypad Reference	E-1
		F	Projector Default Settings	F-1

Note: Due to constant research, the information in this manual is subject to change without notice.

Introduction

1.1 The Projector

The Electrohome *ECP 3500 Plus* series projector is a high resolution data/graphics projector compatible with most input sources. Its high performance places it well above other projection systems in its class. Its features include:

- high definition optics
- automatic input locking between 15 kHz and 72 kHz
- projected display size from 5 to 25 feet (1.52 to 7.62 metres) diagonal
- simple push-button control using the full-function built-in keypad, infrared hand-held remote keypad or optional wired remote keypad
- displayed menus and help screens
- advanced features such as *ASR* and *Auto Power-up*
- an RS-232 serial port interface
- two input slots for interface modules
- a two input RGB interface
- microprocessor control circuitry
- 120V and 240V input voltage capability

Functional Description ►

The projector accepts data/graphics and video input signals from a variety of sources for projection onto flat, curved, or rear projection screens. System inputs are processed to provide separate red, green, and blue image components for projection through the projector's three front lenses. The three primary color components converge on the projection screen to provide a high quality display output.

Processor-based logic and control circuitry provide many of the features designed into the *ECP 3500 Plus*. This circuitry interfaces with the built-in and IR hand-held remote keypads, both of which provide full projector control. Control functions include:

- turning the projector on or off
- switching input sources from interface modules and signal switchers
- adjusting settings such as contrast, brightness, size, and convergence
- correcting for undesirable display effects and input noise
- controlling audio output
- projector selection
- displaying projector operating status screens and help information
- controlling the projector's operating settings

Because projector settings are usually different for different sources, the projector stores display settings for each source individually. These settings

Construction ►

are retained until changed by the user, even if power is removed.
 The projector body is comprised of a metal chassis with removable metal side, front, back and bottom panels for servicing. The hinged top cover is constructed of sturdy moulded plastic.

The projector is designed to accept a variety of input modules. All modules plug directly into the projector via an internal card rack. Simple plug-in of new or upgraded interfaces eliminates time consuming service procedures and increases the reliability of the system.

Expandability ►

The *ECP 3500 Plus* can be expanded or upgraded to include additional features, accessories, and input options; these include a variety of quick plug-in input modules to suit the input devices you are using, a signal switcher, a video multi-standard decoder, and ceiling and floor mount accessories. For more information, or if you need assistance for upgrading your projector, contact your dealer or Electrohome.

1.2 Purchaser's Record and Servicing

Whether the projector is under warranty or the warranty has expired, Electrohome's extensive factory and dealer service network is always available. Electrohome service technicians are fully trained to quickly diagnose and correct projector malfunctions. Complete service manuals and updates are available to service technicians for all new projector models manufactured by Electrohome.

If you have a problem with your projector or require assistance, contact the authorized Electrohome dealer from which the projector was purchased. Fill out the information below for your records.

Purchaser's Record

Dealer:
Dealer Phone Number:
Projector Serial Number:
Purchase Date:

Note: Projector serial is located on the I.D. label at the front of the projector.

Electrohome Service Locations

Electrohome Limited
 809 Wellington Street North
 Kitchener, Ontario
 Canada N2G 4J6
 Telephone (519) 744-7111
 Call toll-free in N.America
 1-800-265-2171
 Fax: (519) 749-3136

Electrohome USA (1989), Inc.
 10282 Sixth Street
 Rancho Cucamonga
 California 91730-5835
 Telephone: (909) 466-3816
 Fax: (909) 466-3824

 181 Cooper Ave.,
 Suite 100,
 Tonawanda, N.Y. 14150
 Telephone: (716) 874-3630
 Fax: (716) 874-4309

Electrohome Europe Ltd.
 ImagePoint
 58 Suttons Park Avenue
 Reading, Berkshire
 UK RG6 1AZ
 Telephone: 0734 266300
 Fax: 0734 266322

Electrohome Asia PTE
 37 Tannary Lane
 #03-05 Tannary House
 Singapore 347790
 Telephone (65) 749 5525
 Fax: (65) 744 2900

Installation & Setup

This section explains how to install and set up the projector. If you are familiar with the projector and want to quickly set it up for temporary use, follow the Quick Setup instructions in section 2.1. For a complete setup, skip section 2.1 and follow the instructions and guides covered in the remaining subsections.

2.1 Quick Setup

Follow these 6 steps for quick set up of the projector:

Step 1 ► **Position the Projector**

For a quick setup, the projector must be positioned so that the distance between the center lens on the projector and the screen is the same as that used during the last optical alignment, otherwise a detailed setup is required. If the projector is new, the projector-to-screen distance should be approximately 87.5" (222 cm). *Note: If a detailed (optical) setup is required, call your dealer or an authorized Electrohome service technician.*

Step 2 ► **Set Supply Voltage and Connect the Power Cord**

Locate the AC line input unit on the lower front panel of the projector. The indicator pin shows 120V or 240V. If it shows the incorrect input voltage, refer to section 2.5 to change the line voltage setting. Next, plug the AC line cord into the line input unit. Plug the three prong end of the line cord into a grounded AC outlet. The green "ready" light will come on.

Note: The line voltage indicator setting must match the power source. The 120V setting covers 90 to 132 VAC. The 240V setting covers 180 to 264 VAC.

Step 3 ► **Connect a Source**

Connect a source to one of the projector inputs. Ensure the source is on and properly connected.

Step 4 ► **Turn the Projector On**

Using the built-in or remote keypad, press and hold **POWER** for one second to turn the projector on. For the IR Remote Keypad, point it towards the screen or the projector lenses. All green voltage LEDs should come on.

Step 5 ► **Select the Input**

Press **SOURCE** **m** **n** to select the source, where *m* is the slot number and *n* is the input number (1 or 2).

Step 6 ► **Adjust the Display**

Press **HELP** **1** to select the Quick Setup guide. The guide provides display adjustment instructions. *Note: Increase Contrast if the image is not visible.*

2.2 Installation Considerations

Careful consideration should be given as to how and where the projection system is installed. Although the performance of the projector is extremely good, the final display quality could be compromised if the projector is not installed properly. This subsection discusses the considerations you should make before proceeding with a final installation. These considerations include the installation type (floor, ceiling, rear), screen size and type, room lighting and ventilation.

Installation Type ►

Choose the installation type which suits your needs: front or rear screen, floor mount or ceiling mount.

Front Screen, Floor Mount Installation

ADVANTAGES	CONSIDERATIONS
<ul style="list-style-type: none"> ● Easy to set-up. ● Can be moved or changed quickly. ● Easy to access projector. 	<ul style="list-style-type: none"> ● Shares floor space with audience. ● May be accidentally moved, necessitating re-alignment.

Front Screen, Ceiling Mount Installation

ADVANTAGES	CONSIDERATIONS
<ul style="list-style-type: none"> ● Does not take up audience space. ● The projector is less noticeable. ● The projector cannot be accidentally moved. 	<ul style="list-style-type: none"> ● Installation is more permanent. ● It is more difficult to physically access the projector.

Rear Screen, Floor Mount Installation

ADVANTAGES	CONSIDERATIONS
<ul style="list-style-type: none"> ● Projector is completely hidden from the audience. ● Easy to access projector. ● Usually good ambient light rejection. 	<ul style="list-style-type: none"> ● Requires separate room. ● Image sharpness may be reduced depending on the screen material used.

Rear Screen, Ceiling Mount Installation

ADVANTAGES	CONSIDERATIONS
<ul style="list-style-type: none"> ● Projector is completely hidden from the audience. ● Usually good ambient light rejection. 	<ul style="list-style-type: none"> ● Requires separate room. ● Installation cost is usually higher. ● Projector hardware access may be difficult. ● Image sharpness may be reduced depending on the screen material used.

Rear Screen, Floor Mount With Mirror

ADVANTAGES	CONSIDERATIONS
<ul style="list-style-type: none"> ● Projector is completely hidden. ● Usually good ambient light rejection. ● Less space is required behind the screen than other rear screen installations. 	<ul style="list-style-type: none"> ● Requires separate room. ● Installation cost is usually higher. ● Image sharpness may be reduced depending on the screen material used.

Note: A qualified service technician is required to configure the projector for a different installation type.

Screen Type ► Screen type is a very important factor when designing a projection system. Inexperienced users or installers should always consult their dealer when deciding on screen type. The following guidelines may be helpful to understand the differences between screen types.

Front Screen Installations

There are two basic screen types: flat and curved. The choice between a flat screen versus a curved screen is dependant on audience viewing angle and screen gain. There is always a trade-off between viewing angle and gain. Viewing angles for both screen types are illustrated in Figures 2-1 and 2-2.

Flat screens offer a gain of about 1 with a viewing angle just less than 180°. Incident light reflects equally in all directions so the audience can see the display from various angles. Because of the lower gain, flat screens are more effective when ambient lighting is reduced.

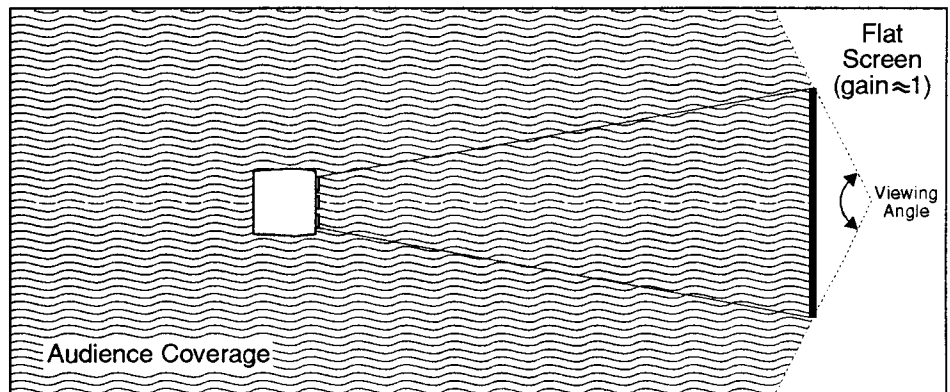

Figure 2-1. Audience Coverage with Flat Screen

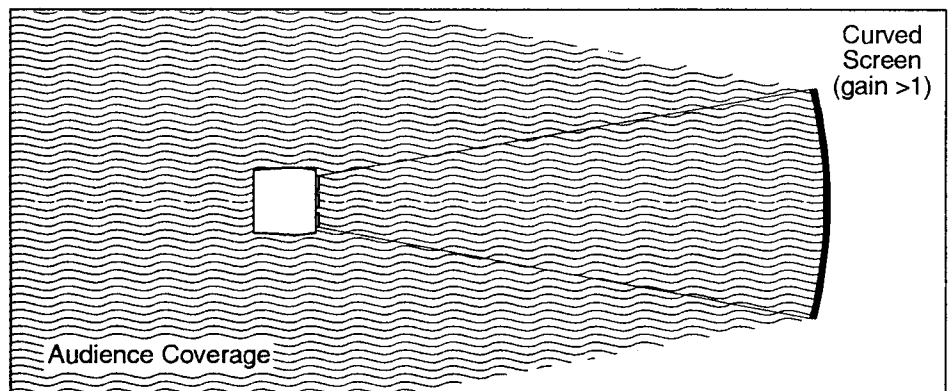

Figure 2-2. Audience Coverage with Curved Screen

Curved screens have gains larger than 1 and viewing angles much less than 180°. Most curved screens have different horizontal and vertical viewing angles. Incident light does not reflect equally in all directions. The reflected light concentrates in a conical volume or "viewing cone". Audiences within the viewing cone see a brighter image than that from an equal area on a flat screen. Audiences outside the viewing cone see a dimmer image.

To summarize, curved screens are better suited for brightly lit rooms where the audience is situated within the viewing cone. Flat screens are best suited when a wide viewing angle is required and ambient room lighting (near the screen) is low.

Note: Screen Gain is defined in Appendix A, Glossary.

Rear Screen Installations

There are two basic types of rear screens: diffused and optical. A diffused screen has a surface which spreads the light striking it. Purely diffused screens have a gain of less than 1. The main advantage of the diffused screen is its wide viewing angle, similar to that of a flat screen for front screen projection.

Optical screens take light from the projector and redirect it to increase the light intensity at the front of the screen. This reduces it in other areas. A viewing cone, similar to that of a curved front screen installation, is created.

To summarize, optical screens are better suited for brightly lit rooms where the audience is situated within the viewing cone. Diffused screens are best suited when a wide viewing angle is required but there is low ambient room lighting.

Screen Size and Distance ►

Screen size and projector-to-screen distance are interrelated. As screen size increases, the distance between the projector and the screen also increases. During projection room design, make sure that the room can accommodate the required position of the projector for the screen size you need.

Screen Size

Screen size may be from 5 to 25 feet diagonal (1.5 to 7.6 meters). Choose a screen size which is appropriate for your application. If the projector will be used to display text information it is important that the image size allows the audience to clearly resolve all text. The eye usually sees a letter clearly if eye-to-text distance is less than 150 times the height of the letter. Small text, located too far from the eye, may not be legible at a distance even though it is projected sharply and clearly on the screen.

To fill a screen with an image, the aspect ratio of the screen must be equal to the aspect ratio of the image. The aspect ratio of an image is the ratio of its width to its height. Standard video from a VCR has a 4:3 or 1.33:1 aspect ratio. For example, to display a VCR output with a 4:3 aspect ratio onto a 10 foot (3m) high screen, the width of the screen must be at least 13.3 feet (4m).

Note: Screen size is often specified as diagonal size. Screens specified by diagonal size have aspect ratios of 4:3. Screens with other aspect ratios are not typically specified by diagonal size.

Throw Distance

The throw distance (projector-to-screen distance) must be determined for every new installation. Throw distance, the distance between the projector's center lens and the center of the screen, is based on the screen size. As screen size increases, the distance between the projector and the screen increases. Make sure that the room can accommodate the required position of the projector for the chosen screen size.

Once your screen size is known you can determine the required throw distance using the calculation below. You can also use the Throw Distance Tables in Appendix B.

$$\textit{Throw Distance} = 1.515 \times \textit{Screen Width} + 9.0'' \textit{ (23cm)}$$

Notes: 1) Calculated values are for reference only. It is good practice to simulate the setup to determine the necessary throw distance. 2) Display size is affected by input signal frequency. Once the projector is set, use the Size function to fine tune display size.

Lighting ►

Proper lighting is another important factor when designing a projection room. Visiting a movie theatre can give you an idea of what makes a good projection environment. All walls, floors and furnishings are dull colored and non-reflectively finished. Every effort should be made to create the best environment for your system.

When designing a projection room try to avoid white, reflective ceilings and non-directional lighting such as fluorescent lights. The white ceiling spreads the light which makes the room appear brighter. You want to keep the lighting and reflections to a minimum. If it is not possible to keep fluorescent lights off, consider using parabolic reflectors ("egg crates") to direct light down to the floor and away from the ceiling. Spot lighting (incandescent) is a better way to obtain illumination. Installing light dimmers or rheostats allows you to control your lighting environment.

Outside windows are undesirable in any projection environment. A small crack between curtains on a sunny day can severely wash-out a projected image. Make sure that curtains are opaque and tightly fitted. Some curtains are designed to provide up to 100 percent blockage of outside light. Pay close attention to the curtain material facing inside the room. It should contain a non-reflective finish.

Even with all lighting removed it is still possible that reflections within the room can degrade the image. Light from the projection screen should be absorbed by the ceilings, walls and floors so that it will not be reflected back to the screen. Again, reflective surfaces should be kept to a minimum.

To minimize the effects caused by unwanted light from door and aisle ways, carefully choose the position of your projector and screen. Figure 2-3 shows an installation where poor screen placement has allowed too much unwanted light to enter the screen. In Figure 2-4, the screen and the projector are positioned so that unwanted light is minimized.

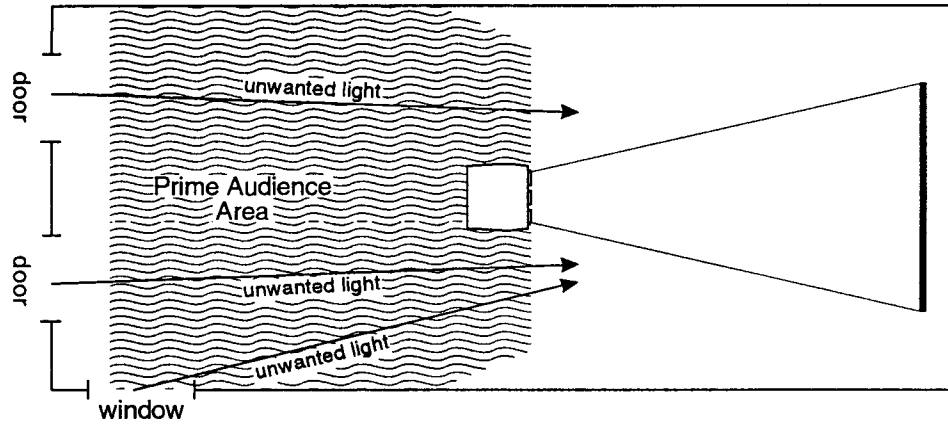

Figure 2-3. *Poor Screen Placement*

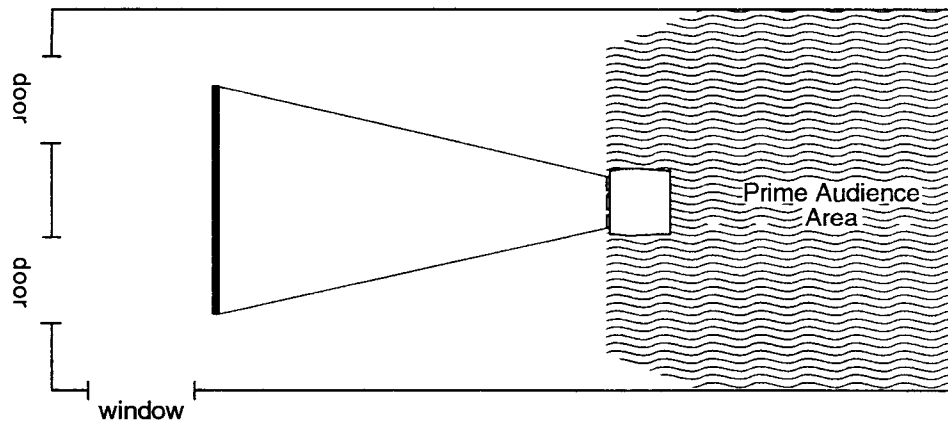

Figure 2-4. *Good Screen Placement*

Other Considerations ➤

Here are some other considerations and tips which can help you improve the design of your projection system.

- Ventilation is an important factor when preparing a projection room. The ambient temperature should be kept constant and below 35 °C (95 °F). Keep the projector away from heating and/or air conditioning vents. Changes in temperature can cause drifts in the projector circuitry which may affect performance.
- Keep the projector away from devices which radiate electromagnetic energy such as motors and transformers. Common sources of these are slide projectors, speakers, power amplifiers, elevators, etc. Keep 35 mm slide projectors at least 2 feet away from the projector. Even if both are not used at the same time, the magnetic fields created by the slide projector can cause permanent magnetization of the projector.
- For rear screen applications, less space is required if a mirror is used to fold the optical path.
- Choose the right screen size for your application:
 - As screen size increases, magnification increases which reduces brightness. This reduces the contrast ratio which affects legibility. Sharp defined edges become soft and fuzzy. Consider whether screen size is more important.
 - Installing a large screen in a small room is similar to watching television close up; too large a screen can overpower a room. A good rule of thumb is to be no closer than 1.5 times the width of the screen.
 - Larger screens require greater attention to lighting conditions.
- When laying out your projection room, consider positioning the projector and screen in a manner which will achieve maximum audience coverage and space efficiency. For example, placing the screen along the larger wall in a rectangular room will reduce audience coverage. Figure 2-5 shows two examples of how audience coverage is maximized.

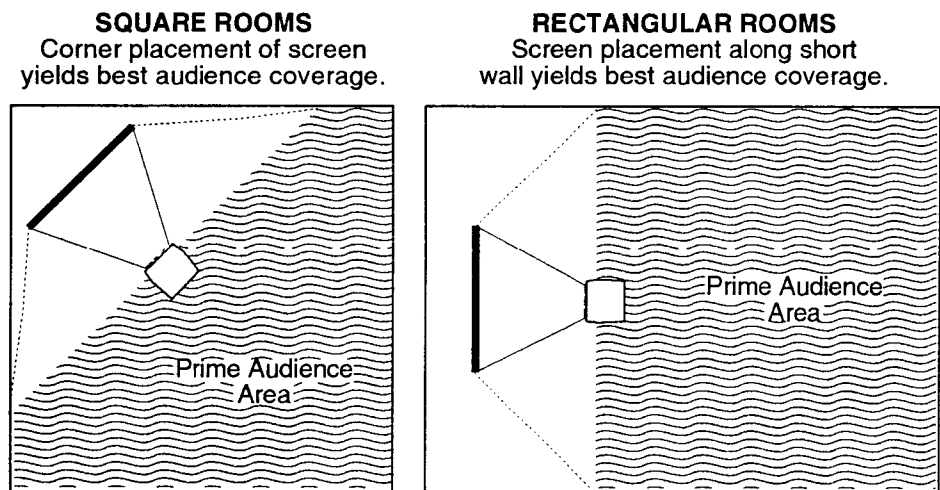

Figure 2-5. Screen Locations for Maximum Audience Coverage

2.3 Keypad Battery Installation

The IR Remote Keypad requires four AA size, 1.5V alkaline batteries (supplied) to operate. To install the batteries, locate the battery compartment at the back side of the keypad. Squeeze the latch to open the door as shown. Place the batteries in the compartment ensuring that the +/- orientation of each battery is correct. Required orientation is identified in the compartment. When complete, position the door into place.

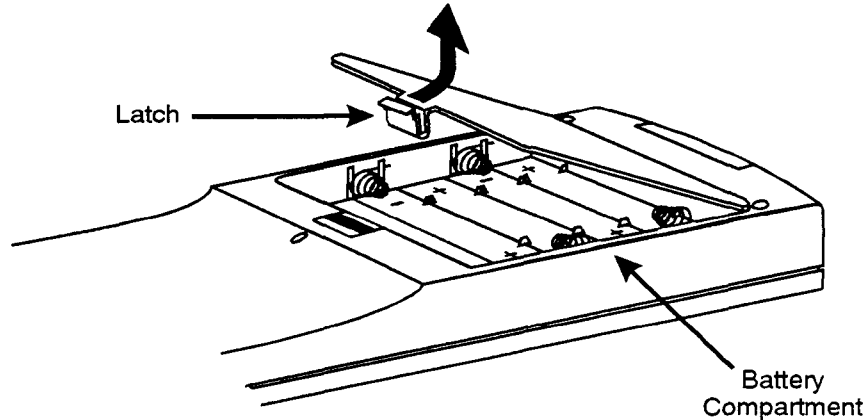

Figure 2-6. Battery Installation

2.4 Mounting

This section provides guidelines and instructions for mounting the projector. Before mounting you must know what operating configuration you require. Possible operating configurations include: front or rear screen, floor or ceiling mount. The projector is configured at the factory for a front screen, floor mount configuration. If a different configuration is required, your dealer or an authorized service technician must change the projector's scan direction settings. For more information, contact your dealer or Electrohome.

Front Screen Installations

Floor Mount

Mount the projector on a secured table or cart. Position the projector at the chosen room location with the projector pointing towards the center of the projection screen. The angle of projection combined with the tilt angle of the screen should direct the reflected image towards the center of the audience. The difference between the projection angle and the screen tilt angle (within a common reference) should be less than 15°. Refer to Figure 2-7.

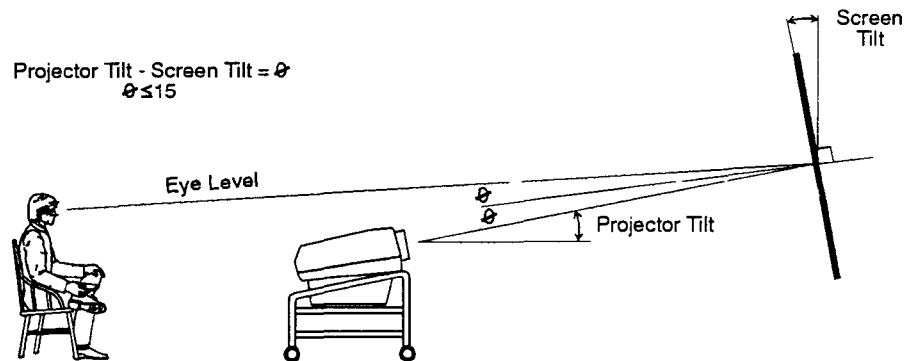

Figure 2-7. Floor Mount Installation

You can adjust the projection angle and level by adjusting the height of the projector legs. See Figure 2-8.

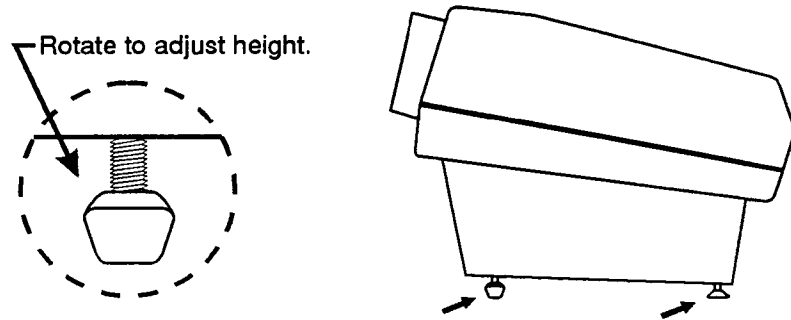

Figure 2-8. *Leg Adjustment*

To make leg adjustments simply grasp the leg (shown above) and rotate it. A clockwise rotation reduces the projector height. A counter-clockwise rotation increases projector height.

Ceiling Mount

Mounting the projector to the ceiling requires the use of a projector ceiling mount fixture. The fixture is shipped from the factory in kit form (with assembly instructions) for assembly and installation by the dealer/installer. For more information, contact your dealer or Electrohome.

Position the projector so that it is pointing toward the center of the projection screen. The angle of projection combined with the tilt angle of the screen should direct the reflected image towards the center of the audience. The difference between the projection angle and the screen tilt angle (within a common reference) should be less than 15°. Refer to Figure 2-9.

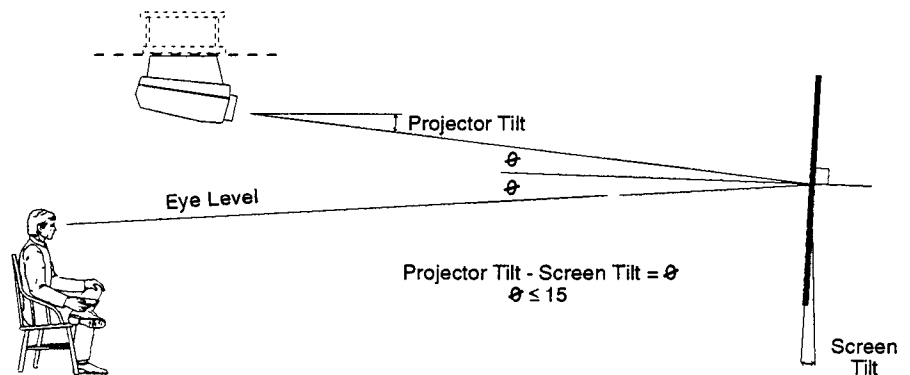

Figure 2-9. *Ceiling Mount Installation*

Rear Screen Installations

When installing a rear screen system, the vertical positioning of the projector is dependant on the type of rear screen being used. There are two basic types of rear screens: optical and diffused.

Optical Rear Screen Systems

If the system includes an optical rear screen, mount the projector along the center axis of the screen as shown in Figure 2-10.

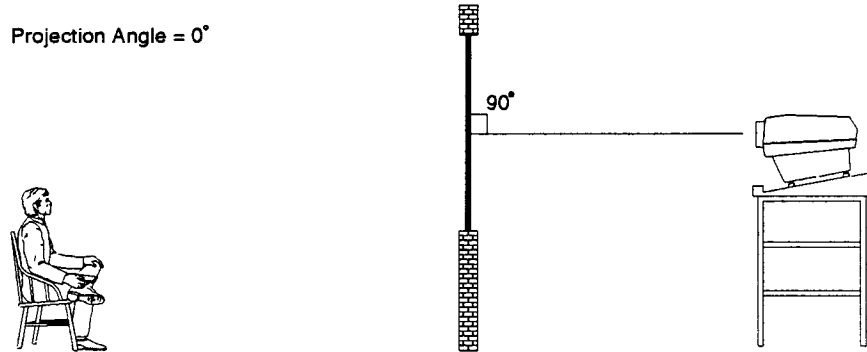

Figure 2-10. Optical Rear Screen Installation

Diffused Rear Screen Systems

If the system includes a diffused rear screen, mount the projector so that the image is directed to the center of the audience. Projection tilt should be less than 15°. See figure 2-11.

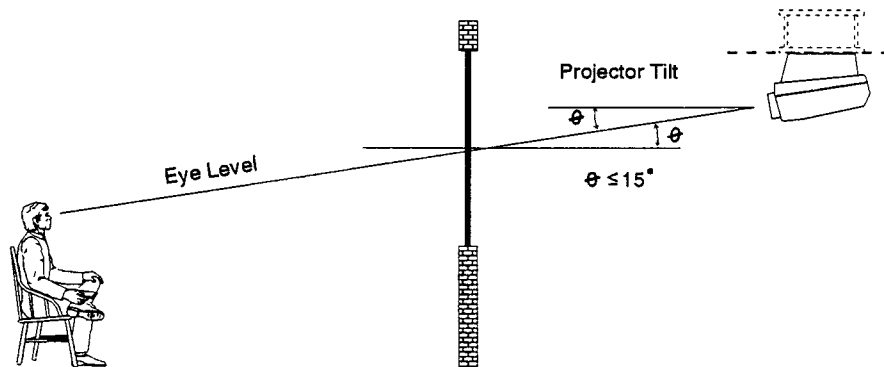

Figure 2-11. Diffused Rear Screen Installation

In situations where the space behind the projector is limited, a mirror may be used to fold the optical path as illustrated in Figure 2-12. If a diffused screen is used, the projection angle θ should be less than 15°. If an optical screen is used, the optical path between the mirror and the screen should be perpendicular to the screen. Much attention must be given to the positioning of the projector and the mirror. This can be quite difficult for installers unfamiliar with this type of installation. It is recommended that your dealer or an experienced installer perform the installation.

Note: When using a mirror as shown in Figure 2-12, the calculated projector-to-screen distance (D) is the summation of D1 and D2.

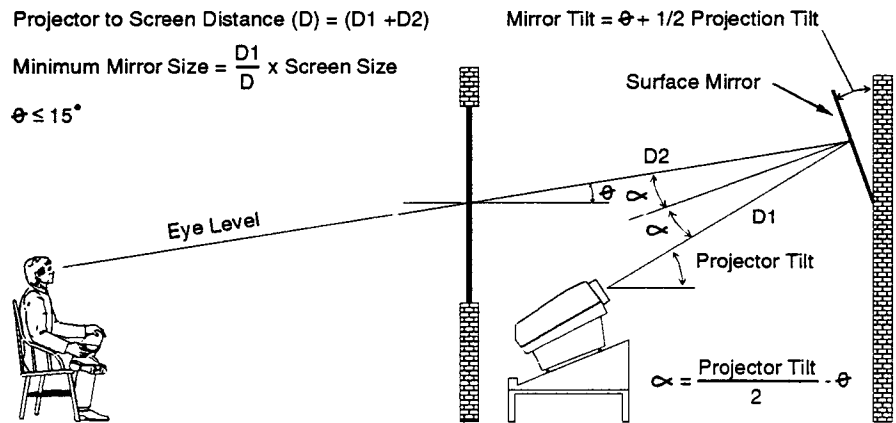

Figure 2-12. *Folded Optics*

2.5 Power Connection

Locate the AC line input unit on the lower front panel of the projector. The indicator pin shows 120V or 240V. The 120V setting covers a 90 to 132 VAC input range. The 240V setting covers a 180 to 264 VAC input range.

If the voltage setting must be changed, remove the line input cover using a small blade screwdriver or similar tool. See Figure 2-13 below.

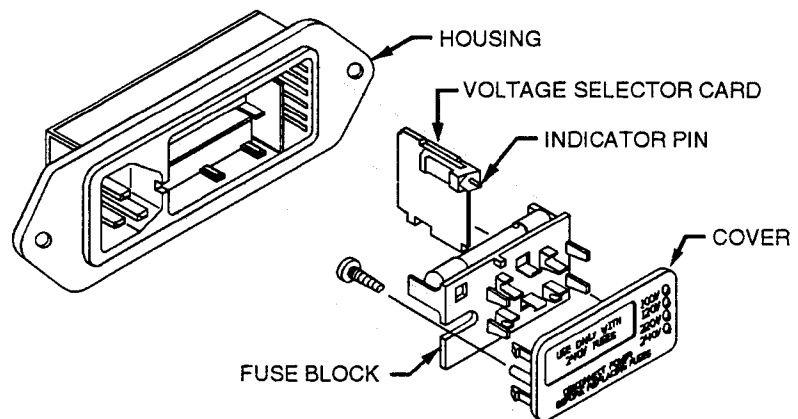

Figure 2-13. *Line Voltage Selection (A)*

A Phillips screw secures the fuse block to the back of the cover. Remove the screw. Flip the fuse block over and install the screw. Make sure one fuse is visible for 120V line voltage and two fuses are visible for 240V line voltage. Next, pull out the voltage selector card using needle-nose pliers. Rotate the pin such that it points away from the desired line voltage. Place the voltage selector card and cover back in place. Check that the pin shows the correct line voltage. See Figure 2-14.

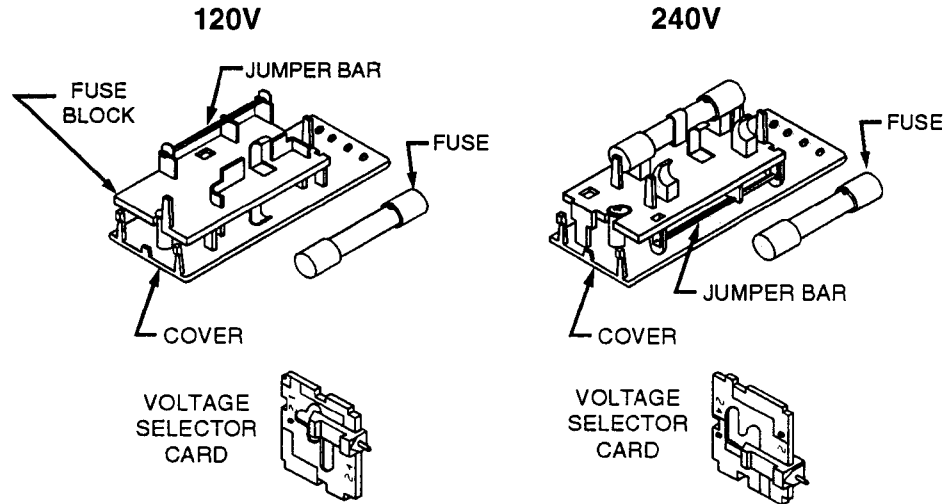

Figure 2-14. Line Voltage Selection (B)

To apply power to the projector, plug the AC line cord into the line input socket. Plug the three prong end of the line cord in a grounded AC outlet. The power source must be capable of supplying 450 watts of power to the projector.

2.6 Source Connections

The projector has two slots to accept input modules: slot 0 and slot 1. An RGB Sync 2 Input module, installed in slot 1, is provided with the projector. Other optional input modules may be installed to increase the total number of inputs and accommodate other signal types. These include an RGB 3,4,5 Wire Loop Thru module, an RGB Sync 10 Pin module, an RGB Sync 10 Pin Direct module, a 2 Input Mono module, a PS/2 (VGA) Interface module, an Enhanced PC Interface module, a TTL Interface module, and a S-VHS Multi-Standard Decoder module.

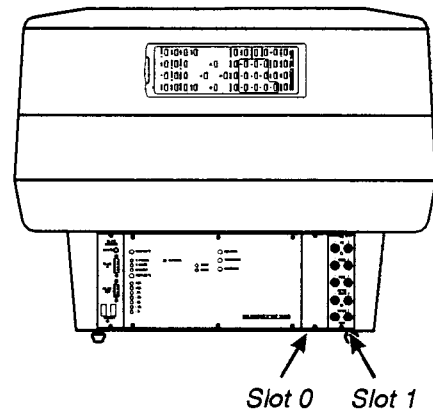

Figure 2-15. Projector Input Slots

With the appropriate input modules installed, up to four sources may be connected directly to the projector for selection using the keypad. A single switcher may be connected if the projector has an RGB Sync 10 Pin input module or a Multi-Switcher Interface module installed in slot 1. With two Multi-Switcher Interface modules installed in slots 0 and 1, up to four Electrohome ECP Video/Data Switchers may be connected to allow source selection of 24 input sources. Descriptions and installation details of optional modules and products are available from your dealer and Electrohome.

Note: If using a single switcher connected to an RGB Sync 10 Pin module, the module MUST be installed in slot 1 of the projector. In this case, slot 0 may only contain an input module with up to two direct source inputs.

The standard RGB Sync 2 Input module allows connection of up to two analog RGB sources, each having one of the following sync types: *sync-on-green*, *composite sync*, or *separate sync*. See Figure 2-16. To connect a source to one of the inputs, connect the red, green, and blue outputs to the red, green, and blue inputs on the input module. If the source uses sync-on-green, no additional cables are required. If the source provides a composite sync output, connect it to the H.SYNC/COMP input. If the source provides separate horizontal and vertical sync outputs, connect the horizontal sync signal to the H.SYNC/COMP input and connect the vertical sync signal to the V.SYNC input. Interconnection cables must be terminated with BNC connectors.

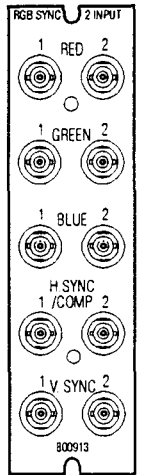

Figure 2-16.
*RGB Sync
2 Input Module*

2.7 Serial Port Connections

Serial port connections are required if you want to electrically link (network) projectors, or control one or more projector(s) by a computer or programmable controller. The projector's serial ports are located on the rear panel communications interface as shown in Figure 2-17. All serial connections require a 9 pin D connector at the projector end. Refer to Appendix D for cable wiring requirements.

Keypad Control Application

Using standard serial communications cables, up to 1000 projectors can be linked together and controlled by a single Wired Remote Keypad (optional). The projectors in the group can be placed many feet apart or even in separate rooms. They do not have to be in viewable range of the keypad. The cable linkage assures reliable communications between projectors and the keypad.

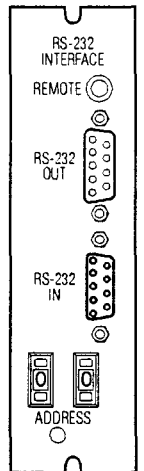

Figure 2-17.
*Communications
Interface*

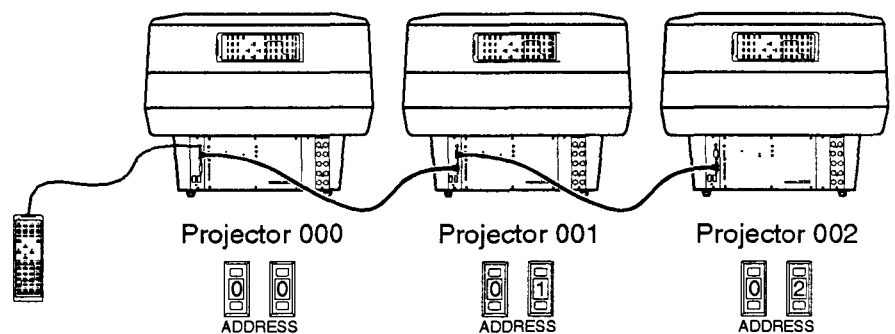

Figure 2-18. *Wired Remote Control of Multiple Projectors*

Projectors are linked using a "chain configuration" as shown in Figure 2-18. The RS-232 OUT port of the first projector is connected to the RS-232 IN port of the next. This continues to the last projector in the chain. For keypad control, a Wired Remote Keypad is connected to the REMOTE input jack of any one of the projectors.

To allow control of individual projectors, each projector must have its own projector identity number and matching network address. To display a projector's identity number, press **[*]**. If you need to change the identity number, press **[HELP]** **[5]** **[5]** to display the Projector ID Number setup screen. Refer to section 3.7, *Utility Features* for setup instructions. The projector's communications address number is identified on the communications interface. To change the network address, use the buttons above and below each of the two digits. The projector's communications software must also be reset. There are two ways to reset the communications software: 1) Turn the projector off, temporarily unplug the AC line cord, then turn it back on again, or 2) Press **[▲]** **[▼]** **[◀]** **[▶]** **[⏏]** on a Wired Remote Keypad connected to the REMOTE port. For instructions on controlling multiple projectors, refer to section 3.8, *Multi-projector Functions*.

Computer/Controller Application

The RS-232 feature also allows the projector to be controlled by a computer or programmable controller. A typical setup is shown in Figure 2-19. The setup is identical to that described for keypad control except that instead of connecting a wired keypad to the REMOTE input jack of one of the projectors, a serial communications cable is connected between the RS-232 serial port of the computer/controller to the RS-232 IN port of the first projector in the chain.

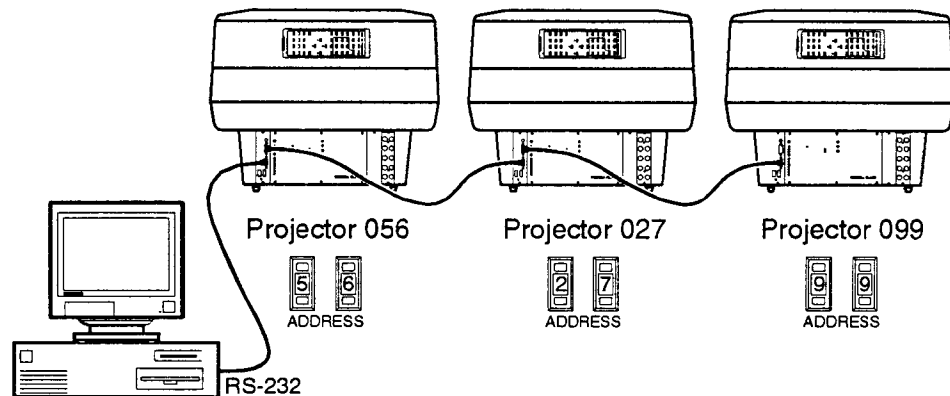

Figure 2-19. Computer/Controller Control

All commands available through the keypad can be sent from the computer or controller. This setup provides many control possibilities. For example, the computer or controller may be programmed to switch input sources at specific times or intervals. It could also be set to automatically turn the projector on at the beginning of each day, and off at the end of each day. If your application requires control by a computer or controller, contact your dealer or Electrohome for technical and setup assistance.





Customization

Network Address

The two digit network address on the communications interface is actually the last two digits of a three digit address. The first digit is internally set at the factory to 0. Your dealer can modify the projector to change the first digit of the address to allow addresses beyond 99, up to 999. For more information, contact your dealer.

Broadcast Mode

The communications interface includes a broadcast mode feature which can be turned on or off. If broadcast mode is set to Off, control commands received from a connected keypad or computer/controller will only be used by that projector. If set to On, control commands will also be broadcast to other projectors connected in the chain. You may use this feature to assign one projector in the group to be the control hub of the network.

Each projector is factory set so that upon power-up, broadcast mode is On. Broadcast mode can be toggled off by pressing      on a Wired Remote Keypad connected to the projector. The new setting will remain in effect until the projector is unplugged. If you want the projector to always power-up with broadcast mode set to Off, contact your dealer to have the factory setting changed.

Communications Baud Rate

The projector is set at the factory to transfer communications data at 9600 baud (bits per second). If necessary, your dealer can change the factory setting to 300, 1200, and 2400. 9600 baud provides the fastest data transfer rate and is recommended for use, however, a lower baud rate may be required for certain installations. Consider operating at a lower baud rate if the distance between adjoining projectors is very large, or the controlling device, for example a computer or programmable controller, cannot operate at 9600 baud. At 9600 baud it is recommended that the distance between adjoining projectors not exceed 50 feet (15.2 meters). As the distance increases, the likelihood of transmission errors increases. Reducing the baud rate can reduce the likelihood of transmission errors.

Note: The baud rate setting of all projectors in the network must be identical. If a computer/controller is used, it must also use the same baud rate.

2.8 Memory Setup

To get full benefit of the ASR feature (briefly explained below), the projector's setup memories must be properly set up. This section explains how to set up projector memories for use by the ASR feature. If you are not familiar with setup memories, read section 3, *Operation* prior to memory setup; in particular, read section 3.4, *Setup Memories*, and the "Auto Source Recall (ASR)" entry in section 3.7, *Utility Features*.

Note: Memory setup should be performed when the projector is in its final operating position. If the physical position of the projector changes, memory setup must be repeated.

Here is a brief summary of the setup memory and ASR discussions in Section 3:

About Setup Memories ...

The projector has 63 setup permanent memories for storing display settings of different sources. Multiple setup memories are required since display settings usually vary for different sources. There are three types of setup memories: Source, Recall, and Zone. All three memory types store the same parameters. The only difference is that Source memories store display settings for a particular physical source input (e.g., switcher 0, slot 1) while Recall and Zone memories can be used with any input.

At any one time, one setup memory is the *current setup memory*. The display settings in the current setup memory are used for the current display; one exception is when ASR is on and ASR has created a temporary memory for use. When a source is selected by entering the slot and input number of its connection route, the Source memory for the selected input becomes the current setup memory. If a Recall memory is selected, it becomes the current setup memory. Display adjustments are automatically saved in the setup memory which is current at the time of adjustment (unless the setup memory is locked or a temporary memory created by ASR is in use).

About ASR ...

ASR is a feature which, when turned on, provides automatic memory selection or automatic source interpolation (ASI) for the current source. ASR processing can activate when 1) a change in scan frequencies is detected at the input, 2) an input is selected, 3) a Recall memory is selected, or 4) a channel is selected. This feature is primarily intended for use when many different sources must share the same input (via a third party switcher, for example) or when a signal source can output several different scan frequencies (e.g., a SVGA card). When a source switch or mode change occurs, ASR attempts to adjust the current display settings to provide the best image for the new input. The settings may be a copy of a Recall, Input or Zone memory with matching scan frequencies, or new settings may be created by interpolating Zone memory settings. The new display settings are stored in a temporary memory. The temporary settings are automatically discarded when a new setup memory is selected from the keypad.

Note: In order for ASR to use other memories, these memories must be "frequency stamped". Refer to section 3.7 for details.

Zone Memory Setup ➤

The projector has five Zone memories. These memories are used by the ASR feature for generating new display parameter settings by interpolation. When ASR attempts an interpolation, it chooses two Zone memories for use: one above the source scan frequency and one below. Selection is based solely on horizontal scan frequency.

Before setting up Zone memories, determine which scan frequencies to use. You can display the current Zone memory setup frequencies by pressing **[*] [*]**. Recommended setup frequencies are shown in Table 2-1. The recommended frequencies cover each end of the projector's two frequency bands with one additional setup within the lower frequency band. For setup, use a multi-frequency signal generator. If a signal generator is not available, Zone memories may be set up using various computer and/or VCR outputs.

Table 2-1. Recommended Setup Frequencies

ZONE #	HORIZONTAL FREQUENCY
1	15.7 kHz
2	21.0 kHz
3	35.5 kHz
4	36.5 kHz
5	64.0 kHz

Note: Though not absolutely necessary, it is good practice to use ascending zone numbers with ascending scan frequencies. For optimum interpolation accuracy, set up zone memories as accurately as possible for convergence, geometry, contrast, etc.



To set up a Zone memory:

Select an input which is at the desired horizontal scan frequency. Press **[SOURCE] [#] [n]**, where *n* is the Zone memory number (between 1 and 5). Adjust all display (and convergence) settings to provide an optimum display output. The display settings are automatically saved in the Zone memory. Press **[SOURCE] [RESET]** to frequency stamp the Zone memory with the input signal scan frequencies. The stamped scan frequencies are used by the ASR logic for Zone memory selection.

Recall Memory Setup ➤

The projector has ten Recall memories (0 to 9) which store commonly used projector setups that can be used with any input. Recall memories are particularly useful when used with the ASR feature.



To set up a Recall memory:

Select an input for display. Press **[SOURCE] [RECALL] [n]**, where *n* is the Recall memory number (between 0 and 9). Adjust all display (and convergence) settings to provide an optimum display output. The display settings are automatically saved in the Recall memory. Press **[SOURCE] [RESET]** to frequency stamp the Recall memory with the input signal scan frequencies. The stamped scan frequencies are used by the ASR logic for Recall memory selection.

Source Memory Setup ➤

The projector has 48 Source memories which store display parameter settings for each physical source input (i.e., Slot 1, Input 2).



To set up a Source memory:

Press **SOURCE** **m** **n** to display the source, where *m* is the slot number and *n* is the input number (1 or 2). Adjust all display (and convergence) settings to provide an optimum display output. The new display settings are automatically saved in the Source memory. Press **SOURCE** **RESET** to frequency stamp the Source memory with the input signal scan frequencies. The stamped scan frequencies are used by the ASR logic for Source memory selection.

Memory Setup Notes & Tips ➤

- Once memory setup is complete, select the current input, i.e., Slot 1, Input 2. It is recommended that Recall and Zone memories not be used (via keypad selection). ASR will automatically use Recall and Zone memories settings as required.
- If you leave a Zone memory as the active setup memory, ASR cannot be activated.
- Set up Zone memories before Recall or Source memories. Zone memory data can be interpolated to make other setups easier.
- To UNDO the changes made to the current setup since it was selected, press **SOURCE** then hold down the **4** key for one second; the source status display briefly flashes and the initial settings are returned.
- A frequency stamp can be removed by copying a non-stamped setup memory to a stamped setup memory via the copy feature in the Utilities menu.

ASR Examples ➤

This subsection provides two examples of how the ASR feature may be used and set up.

ASR Example #1

Refer to the system illustrated in Figure 2-20 below.

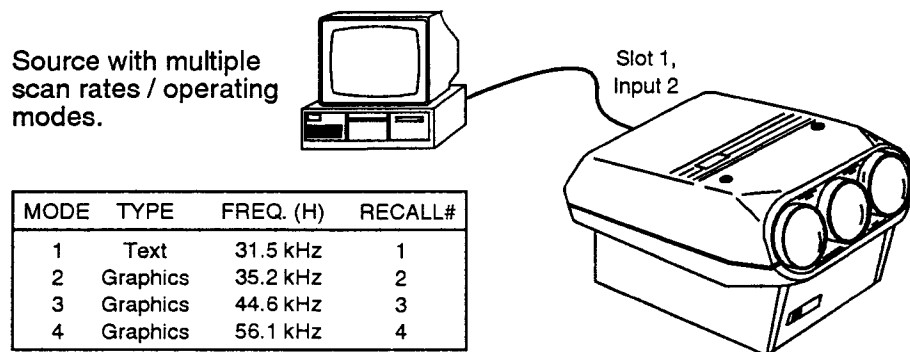

Figure 2-20. ASR Example #1

A computer is connected to input 2 of slot 1 of the projector. The graphics adapter in the computer can operate at different frequency modes to accommodate various software applications. The ASR feature may be used so that when the frequency mode of the computer changes, the projector setup also changes to match that of the new mode.

To prepare setup memories for the above system, follow these steps:

Step 1

Select the source by pressing **SOURCE** **1** **2**.

Step 2

At the computer, switch to an application which uses one of the graphics adapter operating modes. Select an unused Recall memory as the current setup memory. For example, to make Recall memory 1 the current setup memory, press **SOURCE** **RECALL** **1**. Make display adjustments as required. The display settings for the current graphics mode will be stored in the Recall memory. Press **SOURCE** **RESET** to frequency stamp the Recall memory with the input signal scan frequencies.

Repeat this step for the remaining graphics adapter operating modes, storing adjustments for them in Recall memories 2, 3 and 4.

Step 3

Press **HELP** **5** **7** **1** to turn ASR on. Now, each time the computer's graphics adapter switches operating modes, the projector will automatically adjust its display settings to suit the new mode.

ASR Example #2

Refer to the system illustrated in Figure 2-21. Six different sources are connected to a third party (non-Electrohome) signal switcher. Unlike the *ECP Video/Data Switcher*, this third party switcher is not controlled by the keypad. Under normal circumstances the projector is not aware of source switches made by the switcher. However, if ASR is turned on, and a Recall memory has been set up for each source device, the projector will detect the external source switch and automatically select the appropriate Recall memory. If no Recall memories have been set up but the Zone memories have, ASR may interpolate Zone memory data to generate new display settings for each source during selection. To prepare Recall memories for this system, follow these steps:

Step 1

Connect the output of the third party signal switcher to a projector input. Select the input using the Source command. For this example, press **SOURCE** **1** **1** to select input 1 of projector slot 1.

Step 2

At the switcher, switch in one of the source devices. Select an unused Recall memory as the current setup memory. For example, to make Recall memory 1 the current setup memory, press **SOURCE** **RECALL** **1**. Make display adjustments as required. The display settings for the selected device will be stored in the Recall memory. Press **SOURCE** **RESET** to frequency stamp the Recall memory. Repeat this step for the remaining devices.

Step 3

Press **HELP** **5** **7** **1** to turn ASR on. The projector will automatically adjust its display settings to match the source selected by the switcher.

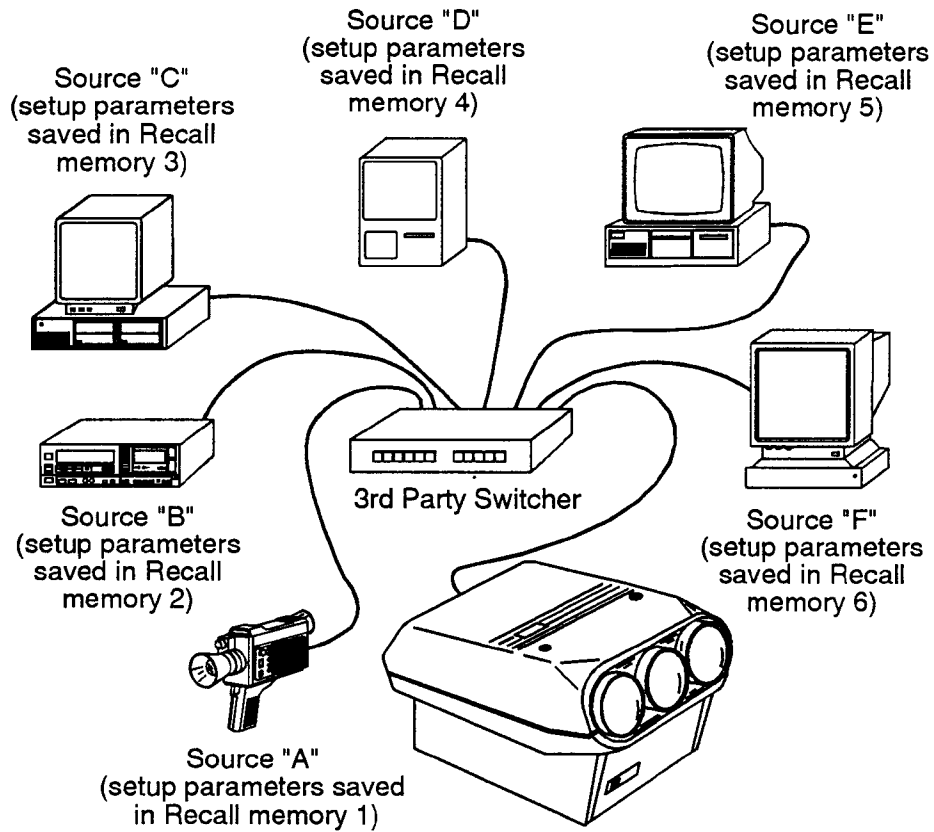

Figure 2-21. ASR Example #2

2.9 ACON Setup



This section provides setup and usage guidelines for systems which include the optional ACON automatic convergence feature.

There are a few simple rules and fundamentals of operation which should be understood and considered when installing a projector which includes the ACON automatic convergence feature. ACON operates on the principle of monitoring projected screen images using its Locator Assembly, analysing this data, then adjusting the vertical and horizontal positions of the red and blue colors until optimum convergence with the green is achieved. This process requires that the view of the display screen by the Locator Assembly be totally unobstructed. ACON's performance can be adversely affected if the projector's optical and system functions are not properly set. Ensure the projector is focused and all user adjustments have been made prior to operating ACON.

Figure 2-22 illustrates four common projection system configurations. ACON responds differently for each configuration. The projector configuration is determined by ACON during the Learn Screen process. Always perform a Learn Screen for a new or changed installation. For more information on Learn Screen, refer to section 3.6, *Convergence Registration*.

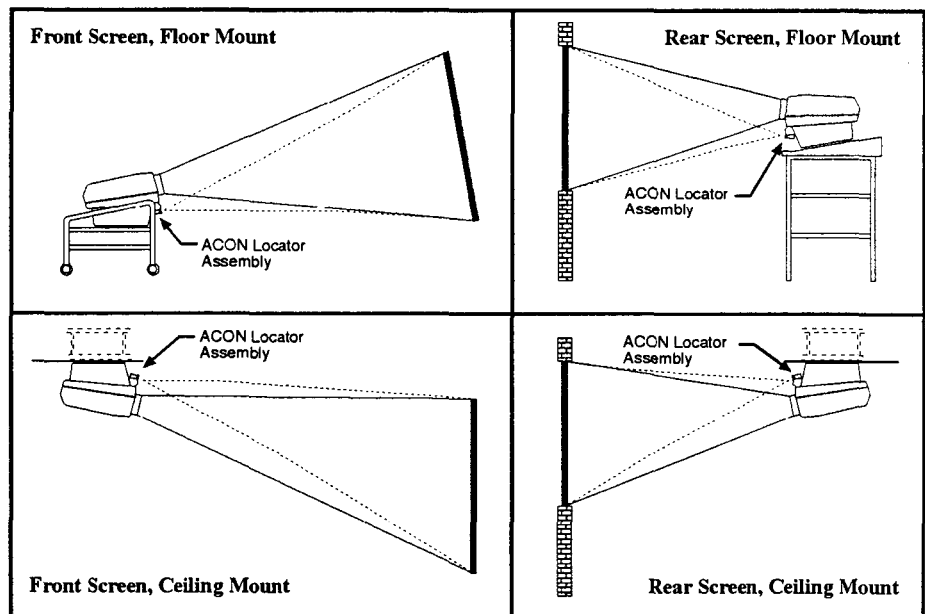

Figure 2-22. ACON Installation Examples

To avoid compromising ACON's performance in rear-screen installations, it is recommended that the Locator Assembly be mounted in front of the display with an optional Locator Mounting Bracket (kit# 38-8000805-01). See Figure 2-23 on the next page. If the Locator Assembly is behind the screen, make sure the screen facing the projector contains a very dark border, otherwise ACON may converge on a surface which is not actually part of the screen. If mirrors are used to fold the optical path, ensure the mirror height accommodates the path required by ACON. A mirror size suited only for the projector will not allow ACON to function properly.

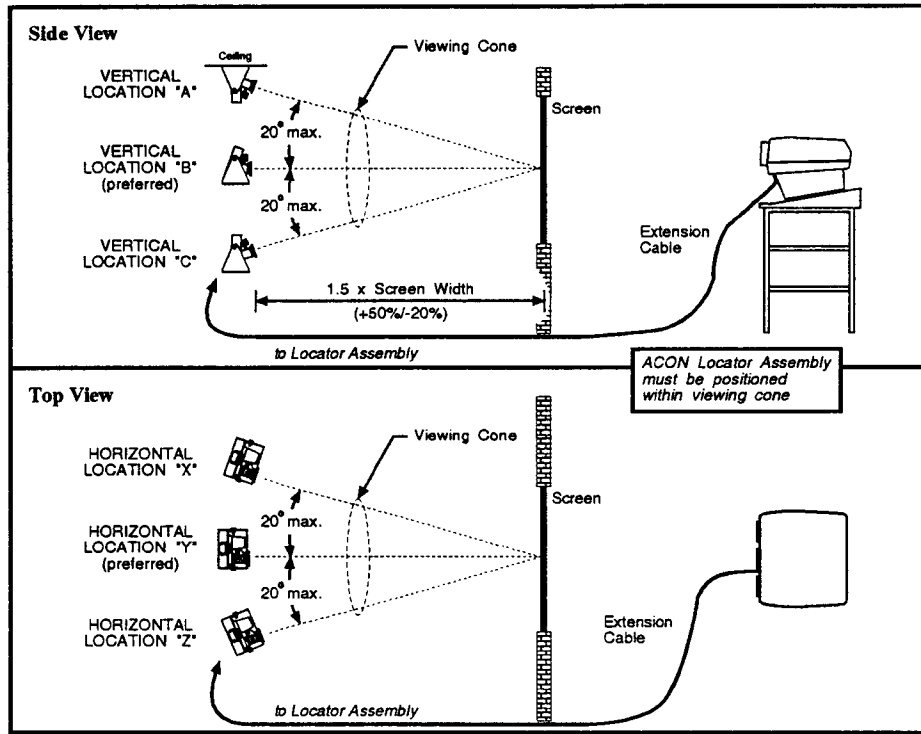

Figure 2-23. Remote Locator Assembly Placement

Operation

3.1 Overview

This section explains how to operate the projector once it has been installed and is ready for use. If you have not yet set up the projector, refer to Section 2, *Installation and Setup*.

Before using the projector for the first time, it is recommended that you read through this section of the manual. Although the projector is easy to use, there are many advanced features which allow you to enhance performance and operation. By understanding these features, and how to use them, you will soon be able to take full advantage of the projector's extensive capabilities.

Organization of this section is as follows:

- 3.1 Overview
- 3.2 Projector Basics
- 3.3 Source Selection
- 3.4 Setup Memories
- 3.5 Display Adjustments
- 3.6 Convergence Registration
- 3.7 Utility Features
- 3.8 Multi-projector Functions

3.2 Projector Basics

Notice that the projector has no external knobs or moving parts to make adjustments or change control settings. This is because all user adjustments are digitally controlled via the projector's built-in or remote keypad. Adjustment settings are retained in the projector's internal memory, even when the projector is unplugged.

Keypads ►

Four different keypads may be used with the projector: the Built-in Keypad, the IR Remote Keypad, the Wired Remote Keypad, and the Presenter's Keypad. The Built-in and IR Remote keypads are supplied with the projector. The Wired Remote and Presenter's keypads are optional. Use the keypad which is most appropriate for your application.

Built-in Keypad

The Built-in Keypad is the projector's primary keypad; it is a *full function* backlit keypad which enables control of all user functions (adjustments and control settings). This keypad is located at the back of the projector as shown in Figure 3-1. It is primarily intended for initial projector setup.

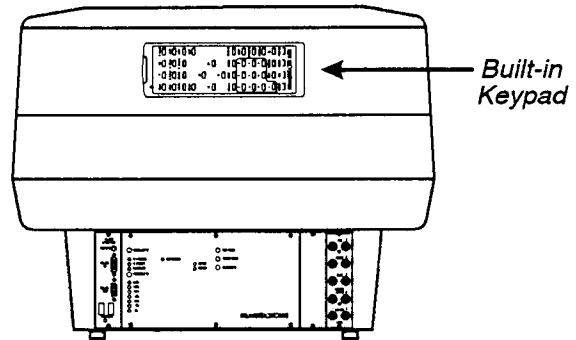

Figure 3-1. Built-in Keypad

IR Remote Keypad

The IR Remote Keypad is similar to the Built-In Keypad except that it allows the user to control the projector remotely. The keypad includes a battery powered infrared (IR) transmitter for wireless control. The IR Remote Keypad also includes illuminated keys for easy viewing in a projection room environment.

Presenter's Keypad (optional)

The Presenter's Keypad is similar to the IR Remote Keypad except that it is not a full function keypad; it contains only frequently used keys. Presenters may find that the Presenter's Keypad is easier to use than a full function keypad. For more information about the Presenter's Keypad, call your dealer or Electrohome.

Wired Remote Keypad (optional)

The Wired Remote Keypad is similar to the IR Remote Keypad except that it connects externally to the projector by a 25 ft extension cable. It plugs into the REMOTE input jack at the back of the projector. The Wired Remote Keypad is recommended when:

- the location of the keypad with respect to the projector or screen is inadequate for IR Remote Keypad operation,
- the projector is in a lighting environment which is unsuitable for IR Remote Keypad operation,
- there are multiple projectors in the same room and you want each projector to be controlled by its own remote keypad, or
- multiple projectors are linked by their RS-232 serial ports and you want to control all projectors from one wired keypad.

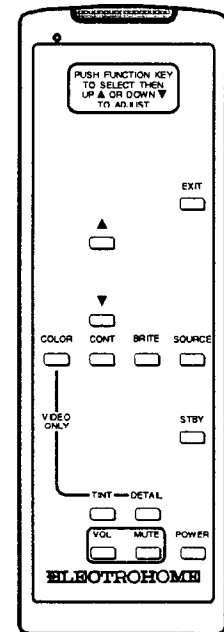

Figure 3-2. Presenter's Keypad

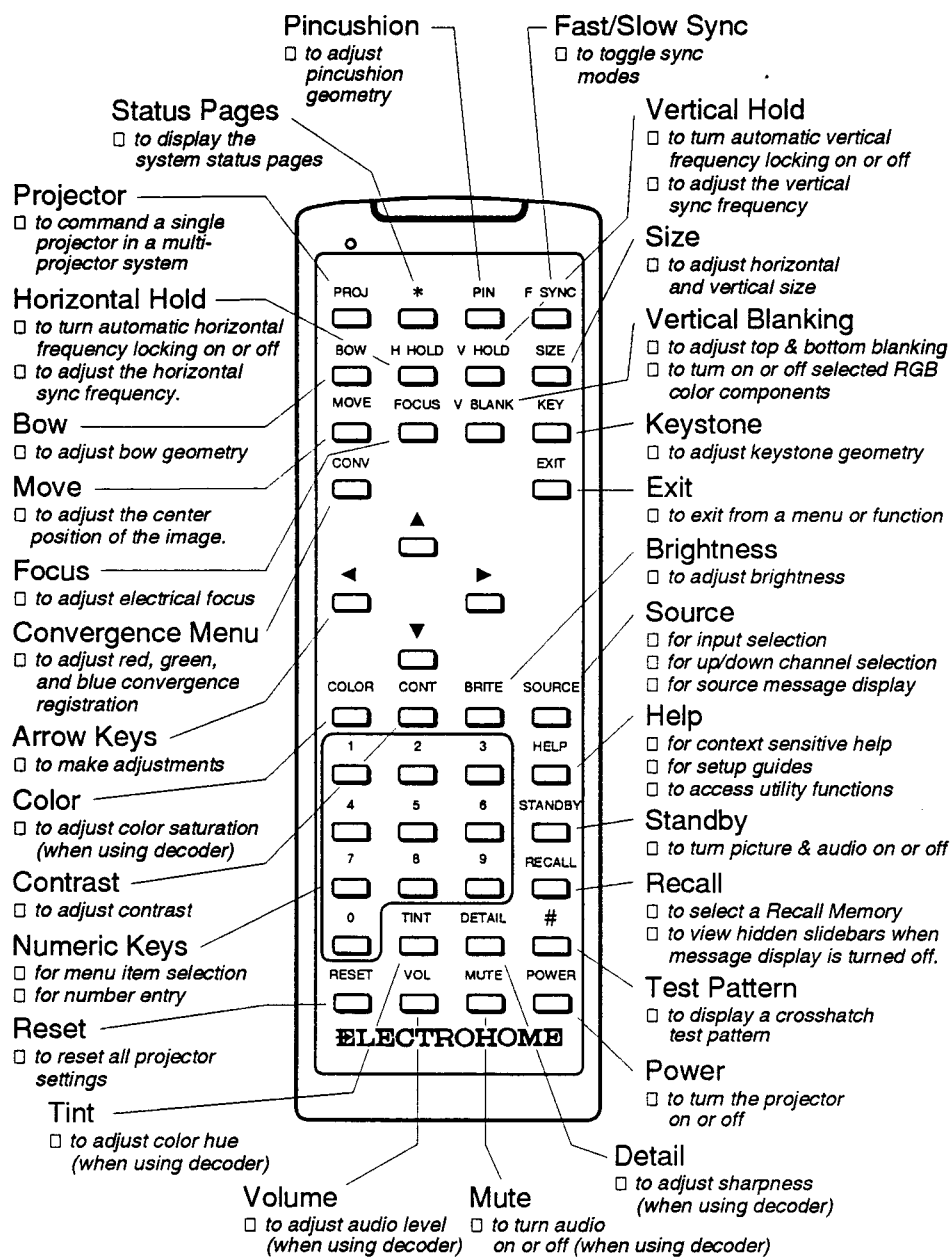

Figure 3-3. Full Function Keypad

Keypad Usage ► To use the keypad there are only a few general rules to remember:



Key Press Rules

- 1) No functions require simultaneous key presses.
- 2) **POWER** and **STBY** require an extended hold-down for function activation (about one second).
- 3) **▲**, **▼**, **◀**, and **▶** are the only keys which repeat when held down. For all other keys, release the key then press again for repeated activation.
- 4) If keys are pressed at a time when the projector is busy (such as during power-up), the key presses may not take effect.

Figure 3-3 shows the projector functions which are accessible from a *full function* keypad. Most functions are accessed directly from the keypad while others, such as the utility functions, are accessed through on-screen menus.

When the projector is turned on it begins operation at *Presentation Level*. Presentation level is the normal level of operation at which a source image is (or may be) displayed. The projector temporarily leaves presentation level when menus are displayed, control settings are changed, or online help is accessed. The screen display changes to reflect the operation or function being performed. One or more of the following may be displayed:

- Slidebar - to make adjustments to display settings.
- Menu - to select projector functions.
- Input Screen - to enter control settings.
- Confirmation Screen - to confirm or cancel an indicated action.
- Message - to display status information.
- Help Page - to display help and provide assistance.
- Test Pattern - to assist during setup.

Each of the above are explained in the following entries. As you read through the explanations, note the following:



In most cases ...

EXIT brings you back to presentation level,

HELP provides context-sensitive help.

(Note: The display of slidebars and messages can be suppressed if desired. For more information, refer to section 3.7, Utility Features).

Slidebars

When an adjustment is made a slidebar is superimposed on the image. The slidebar displays the adjustment setting on a scale of 0 to 10. To make an adjustment, use the arrow keys. In most cases the **▲** and **▼** keys are used. For some functions, such as side pincushion adjustment, the **◀** and **▶** keys are used. If no keys are pressed within 5 seconds or **EXIT** is pressed, the slidebar disappears from the display.

For example, if **BRITE** is pressed, the Brightness Slidebar is superimposed on the image. The slidebar shows that brightness is set to 5. Press **▲** or **▼** on the keypad to change the brightness level.

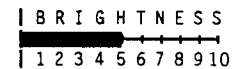

Menus

Some functions are accessed through menus which contain a list of items for selection. These items may include adjustment functions, control settings or additional menus.



To make a selection from a menu, simply press the number key corresponding to the item number.

Input Screens

Input screens allow you to change or enter projector control settings. For each input screen, instructions for data entry are provided by pressing **[HELP]** while the screen is displayed.

Confirmation Screens

Confirmation screens are displayed after performing convergence. These screens allow you to accept or discard recent convergence changes. For more information, refer to section 3.6, *Convergence Registration*.

Messages

Messages are briefly displayed on the screen to indicate a status, condition, or error. Messages are overlaid on the source image and most remain on the screen for about five seconds. To remove a message prior to the five second display period, press **[EXIT]**.

Help Pages

Help pages provide assistance when you need it. There are various forms of help available, all accessible by pressing **[HELP]**. For information about using help, refer to the *Using Help* entry in this section.

To exit from a help screen, press **[EXIT]**.

Test Pattern

The projector has an internal generator which can display a crosshatch test pattern for use during projector setup. The test pattern is displayed at the horizontal and vertical scan frequencies of the current input signal. Press **#** to display the test pattern. Press **#** again (or **[EXIT]**) to remove it.

The test pattern replaces the current display until it is turned off by the user. It is recommended that the test pattern be used when performing geometry correction functions such as Bow, Pincushion and Keystone.

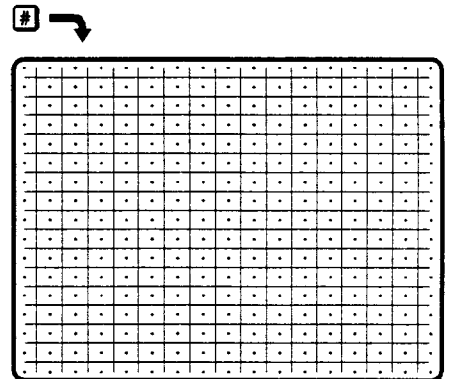

Note: Excessive time with high contrast and/or brightness levels during test pattern display may damage the projector's CRTs.

Using Help ► The projector includes an extensive online help system. The help system provides operational guidance and assistance. There are two types of online help: Context Sensitive Help and Guided Help.

Context Sensitive Help

Context Sensitive Help is used to display help pages pertaining to a specific keypad or menu function.



To view help pertaining to a keypad function, press the function key then **HELP**. If multiple help pages are available, press **HELP** to display the next page. Press **EXIT** to return to the image. To access help for menu items, simply press **HELP** after the item is selected.

For example, to view a help page which describes the brightness function, press **BRITE HELP**. To exit the help display, press **EXIT**.

Guided Help

Guided Help provides tutorials which explain how to operate the projector.



To access the tutorials, press **HELP** at presentation level. The Help menu is displayed. Select a guide from the help screen by entering its menu number. When using the tutorials, press **HELP** or **▶** to display the next tutorial page. Press **◀** to display the previous page. Press **EXIT** to return to the image.



```

HELP AND UTILITIES MENU
1. QUICK SETUP GUIDE
2. DETAILED SETUP GUIDE
3. KEYPAD GUIDE
4. SOURCE SELECTION GUIDE
5. UTILITIES

PRESS EXIT TO RETURN
  
```

1. Quick Setup Guide

The Quick Setup Guide provides a step-by-step procedure for quick setup of the projector, which may be performed while proceeding through the tutorial.

Note: If the image cannot be focused, ensure that the throw distance is correct (see section 2.2). If the image still cannot be focused, have an authorized service technician optically set up the projector.

2. Detailed Setup Guide

The Detailed Setup Guide provides instructions for service technicians when optically aligning the projector. Optical alignment is necessary when the screen size changes, the projector-to-screen distance changes, or the image does not focus using the focus control. Optical alignment is performed by your dealer or an authorized service technician.

3. Keypad Guide

The Keypad Guide explains keypad usage and the functions of each key.

4. Source Selection Guide

The Source Selection Guide explains various source selection methods.

Power-on ► To turn on the projector, press **POWER** on the keypad. Hold it down for about one second. If using the IR Remote Keypad, point the keypad at the projection screen or the front of the projector. During power-on, the projector proceeds through a series of internal diagnostic tests which last approximately eight seconds. Once complete, an input image should be displayed on the projection screen. If no image is displayed, press **SOURCE** to display the source message. The source message indicates the currently selected input. Check that the correct source is indicated on the display.

If having difficulties obtaining a display, press ***** to display the projector status page. If there is no display when ***** is pressed, the contrast setting may need to be increased. Also, check the LEDs (Light Emitting Diodes) on the projector back panel. The green READY LED and all voltage LEDs (200V, 150V, -24V, +24V, -12V, +12V, +5V) should be illuminated. The following LEDs should be off: ERROR, V.MANUAL, H.MANUAL, V.INHIBIT, and H.INHIBIT. If this is not the case, call your dealer for assistance.

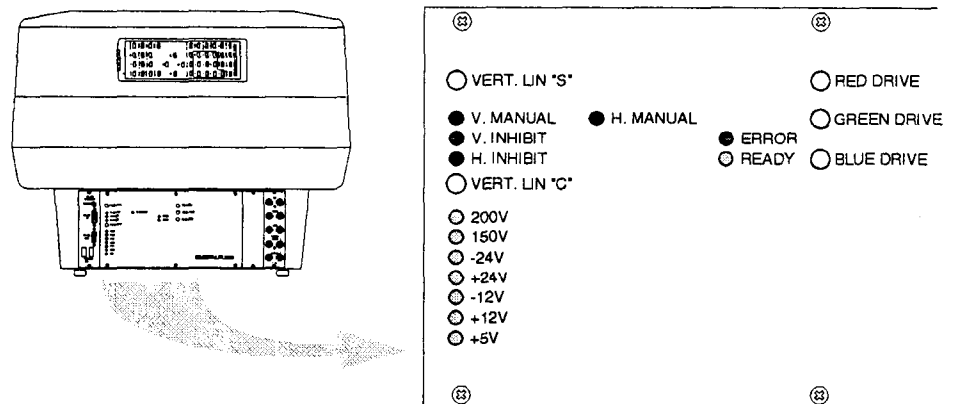

Figure 3-4. Rear Panel LEDs

Notes: 1) Make sure the lens covers have been removed before turning the projector on. 2) Allow the projector to warm up for 45 minutes before use. Critical adjustments should be made only after the warm-up period. 3) Turning the projector off using a keypad places the projector in a low power "wait to operate" mode. To completely remove power, unplug the power cord.

Standby Mode ► Standby Mode allows you to blank the display and mute the audio output while keeping the projector in a warmed-up and ready state.



To enter standby mode, hold down **STBY** for about one second at presentation level. The display blanks and audio is muted. To leave standby mode, hold down **STBY** or **EXIT** for one second. The display and audio are then restored.

Tip: The standby feature is useful during presentations when you want to direct audience attention away from the projection screen.

Note: To prolong CRT life it is recommended that the standby feature be used when the display is not required.

Audio Functions ▶

Mute

The Mute function is used to silence audio output when using an optional decoder module.



To silence the audio output, press **[MUTE]**. Press **[MUTE]** again to restore audio.

Note: The use of the Mute function does not alter Volume settings.

Volume

The Volume function is used to adjust the audio level when using an optional decoder module.



To adjust Volume, press **[VOL]** then **[▲]** or **[▼]** until the desired audio level is attained.

System Status Pages ▶

The projector's current operating settings may be displayed by pressing **[*]** while at presentation level. The first press of **[*]** displays a status page containing general projector information. A second press of **[*]** displays an ASR (Automatic Source Recall) status page. Both pages are displayed for approximately ten seconds. To return to presentation level before the ten second time-out, press **[EXIT]**.



```

ELECTROHOME
V X . X   X X X X X X X X
SWITCHERS 1 2 3 4
ECP X X X X S E R I E S
MUTE OFF                                CHANNEL 01
PROJ 000 ON                             SWITCHER 010
PROTOCOL ONE                             INPUT 010
UPRIGHT ON FRONT SCREEN                  RECALL 0
AUTO POWER-UP OFF
CURRENT:  H 38.0 KHZ
          V 61.5 HZ
ASR OFF
    
```

Each item in the first status page is described below.

VX.X XXX XX XXXX shows the version number and the release date of the projector software.

SWITCHERS 1, 2, 3, 4 shows which switchers are connected to the projector. If no switchers are connected, nothing is shown in this space.

ECP XXXX SERIES shows the model series to which the projector belongs.

MUTE shows the current on/off status of the Mute function.

PROJ shows the projector's three digit identification number and its infrared listening status (on/off).

PROTOCOL shows which keypad protocol (1 or 2) the projector is set to respond to.

AUTO POWER-UP shows the current setting of the Auto Power-up feature.

UPRIGHT ON FRONT SCREEN shows the mounting configuration of the projector.

H 38.0 KHZ shows the horizontal frequency of the current source (example - 38.0 kHz).

V 61.5 HZ shows the vertical frequency of the current source (example - 61.5 Hz).

ASR shows the current setting of the Auto Source Recall feature.

CHANNEL shows the currently selected channel from the Channel List. If a channel is not selected, nothing is shown.

SWITCHER shows the currently selected switcher (1 to 4). If no switchers are selected (or installed), nothing is shown.

SLOT shows the currently selected input slot (0 or 1). If a switcher is selected, the slot number may be between 1 and 6.

INPUT shows the currently selected input (1 or 2) of the input module in the identified slot.

RECALL shows the Recall memory in use for the current display (0 to 9). If a Zone memory is the active setup memory, ZONE and the Zone memory number (1 to 5) is displayed instead. If a Source memory is the active setup memory in use, nothing is shown in this space.

The ASR Status Page is helpful to users who operate the projector with ASR turned on. The status page displays all Zone and Recall memory scan frequencies, and the scan frequencies stored in the Source setup memory of the physical source input. The ASR feature (briefly described here) enables automatic adjustment of the projector's display settings when the input signal frequency changes at the source end.



ASR STATUS		
MEMORY	HORZ	VERT
ZONE 1	15.70	60.00
ZONE 2	18.00	60.00
ZONE 3	26.50	60.00
ZONE 4	27.50	60.00
ZONE 5	62.00	60.00
RECALL 0	16.20	60.00
RECALL 1	19.00	60.00 *
RECALL 2	19.00	60.00
RECALL 3	0.00	0.00
RECALL 4	0.00	0.00
RECALL 5	-	-
RECALL 6	-	-
RECALL 7	-	-
RECALL 8	-	-
RECALL 9	-	-
PHYS 3, 1, 2 48.00 70.00		
* MEMORY ASR WILL USE		
PRESS EXIT TO RETURN		

When a change is detected, the projector may adjust its display settings to match those stored in another Recall or Zone memory with matching scan frequencies, or create new display settings by interpolating Zone memory settings.

PHYS 3, 1, 2 (shown above) indicates that the current physical source input is switcher number 3, slot 1, input 2. If the source is not from a switcher, only the slot and input numbers are displayed. In the example shown, 48.0 and 70.00 are the horizontal and vertical scan frequencies which have been frequency stamped in the Source setup memory. (Frequency stamping is described in the ASR entry in section 3.7).

Scan frequencies which indicate a 0.00 or "-" indicate that the memory is not frequency stamped, thus the setup memory will not be used by the ASR feature. A "-" further indicates that the memory has never been selected for use by the user. A frequency stamp can be removed by copying a non-stamped setup memory to a stamped setup memory via the copy feature in the Utilities menu.

An asterisk (*) indicates which memory ASR will use when two memories have the same horizontal and vertical scan frequencies.

For more information about ASR, Recall memories and Zone memories, refer to sections 3.4 and 3.7.

3.3 Source Selection

The projector includes an RGB Sync 2 Input module in slot 1. Slot 0 is empty. Optional input modules are available which can be installed in either of the two slots. With optional modules and the use of one or more external switchers, the number of inputs can be significantly increased. Because of this large capability, three source selection methods are available: Input Selection, Direct Channel Selection, and Up/Down Channel Selection. Sources are selected at presentation level.

Note: For installations with only one or two source connections, direct input selection may be the only method needed. If your system includes many sources, all methods may be of interest.

Input Selection ➤

This method is the most basic of the three source selection methods. A source is selected by specifying the input to which the source is connected, defined by a slot number and input number.

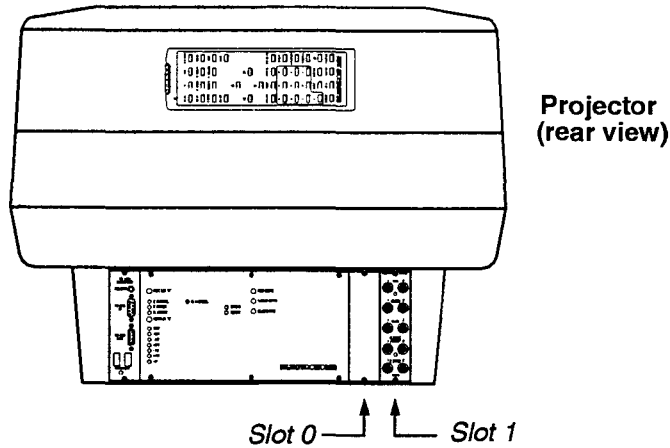

Figure 3-5. Projector Slots

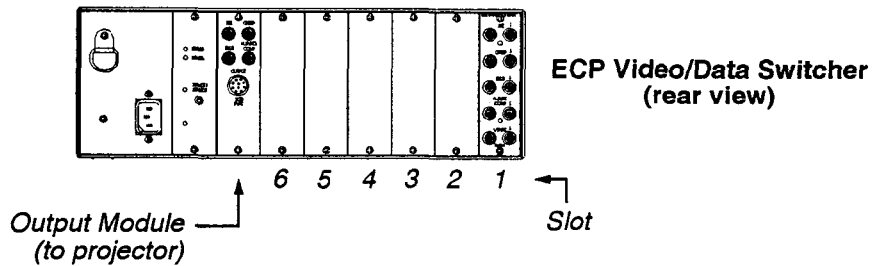

Figure 3-6. Switcher Slots



To select an input:

Press **SOURCE** **m** **n**.

where: *m* = slot number (0 or 1, or 1 to 6 when using a switcher)

n = input number (0 or 1)

The projector switches to, and displays, the source connected to the input selected. The projector also uses the display settings previously set in memory for that input. If the selected input is invalid, a warning message is displayed.

If the system includes a switcher connected to a switcher input module in slot 1, up to 6 switcher inputs may be selected. The slot and input number in the Source command refer to the switcher slot and input number. If your system includes more than one switcher (via one or two multi-switcher interface modules), you must indicate to the projector which switcher your Source commands refer to. To do this, press **SOURCE** * **n**, where **n** is the switcher number (1 to 4). When a source selection is made, the slot number (1 to 6) then refers to the switcher slot number. Refer to the *ECP Video/Data Switcher* user's manual for more details.

Example 1

Slot 1, Input 2 on the projector has the output from a computer workstation connected to it. To display the workstation output, press **SOURCE** **1** **2**.

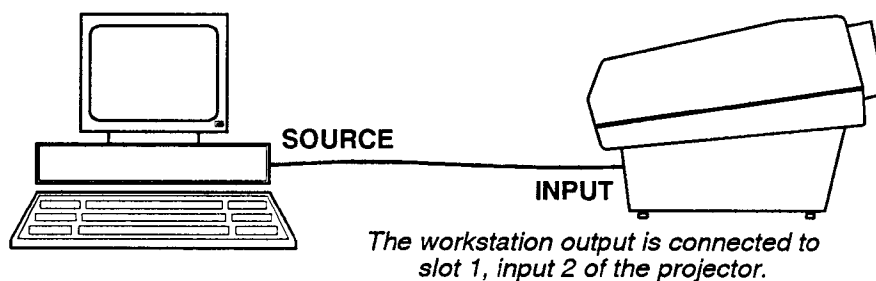

Example 2

An single *ECP Video/Data Switcher* is connected to the switcher input in slot 1 of the projector. A computer is connected to input 2 of a module in slot 3 of the switcher. To display the computer output, press **SOURCE** **3** **2**.

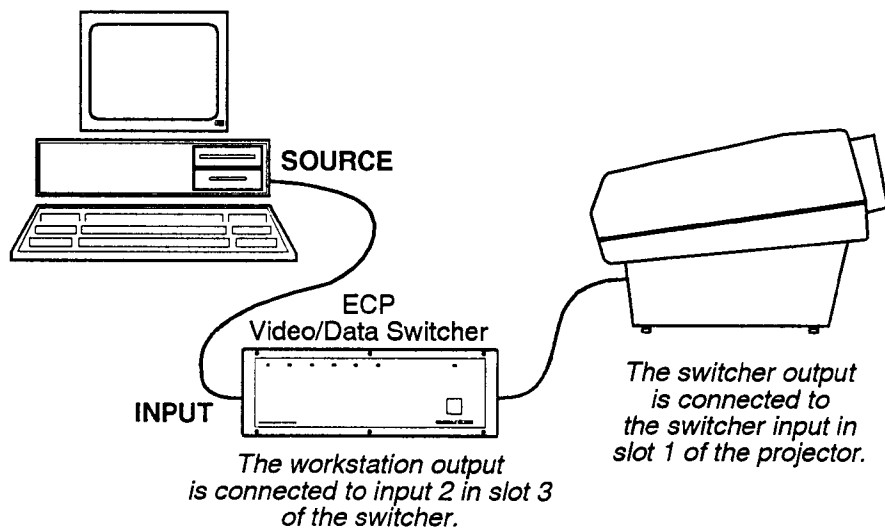

Direct Channel Selection ►

This method of source selection takes advantage of the Channel List feature explained in section 3.7, *Utility Features*. The Channel List allows you to assign a source to a 2-digit number, from 01 to 48.

Once you have assigned channel numbers to your sources, and the projector is at presentation level, you can select a source by pressing the 2-digit channel number associated with it.



To select a channel, press **[m]** **[n]**.

where: *m* = the 1st digit of the channel number
n = the 2nd digit of the channel number

The projector switches to, and displays, the source assigned to the channel number. If an invalid switcher or slot number is assigned to the channel a warning message is displayed.

Example

Channel 08 in the Channel List was programmed to select a source connected to input 1 of a module in slot 5 of switcher 3. To select this source, simply press **[0]** **[8]**.

Up/Down Channel Selection ►

This method of source selection also takes advantage of the Channel List feature. It lets you quickly switch between channels programmed in the Channel List by using the up and down arrow keys on the keypad.



To make a selection:

Press **[SOURCE]** followed by **[▲]** or **[▼]**.

Each time an arrow key is pressed a channel number is displayed in the lower right portion of the screen. When the desired channel number is displayed, simply wait to allow the projector to switch to the source defined by the channel.

Note: If a channel specifies a switcher which does not exist, the channel is considered invalid.

The Source Message ►

When **[SOURCE]** is pressed at presentation level and/or a source switch is made, a source message is briefly overlaid on the image. The source message displays information about the current source, as shown in the diagram.

*Note: If messages are turned off via the Screen Messages menu (**[HELP]** **[5]** **[4]**), the source message is not displayed.*

[SOURCE] →

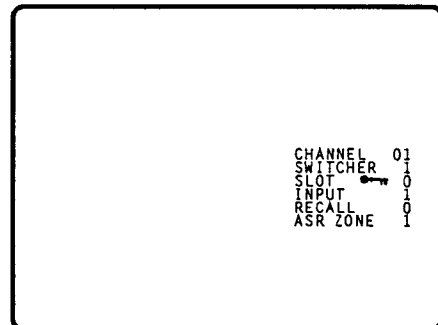

Channel Number

If a valid channel has been selected, the channel number is displayed; otherwise this line is blank.

Switcher Number

If a switcher has been selected, its number is displayed (1 to 4). If no switcher is selected (or installed), this line is blank.

Slot Number

The slot number of the active input is displayed (0 or 1). If a switcher is selected, the slot number may be between 1 and 6.

Input Number

The input (1 or 2) selected for the slot is displayed. If the Source memory for the input is locked, a key icon () is displayed. Setup memories which are locked are not affected by adjustments to display settings. For an explanation of Source memories and locked memories, refer to section 3.4, *Setup Memories*.

Recall Memory Number

When a Recall memory is in use, the Recall memory number (0 to 9) is displayed. If a Zone memory is the active setup memory, ZONE and the Zone memory number (1 to 5) is displayed instead. If a Source memory is the active setup memory in use, nothing is shown in this space.

ASR Message

If the ASR feature is set to On and ASR changed the display setting by selecting a different setup memory, an ASR message is displayed to indicate the action taken. For example, ASR ZONE 1 indicates that ASR changed the display settings to the settings stored in Zone memory 1. For more information about the ASR feature, refer to the ASR entry in section 3.7, *Utility Features*.

3.4 Setup Memories

The projector has 63 setup memories for storage of display settings. Multiple setup memories are needed because display settings are usually different for different sources. For example, the display settings (brightness, convergence, etc.) needed for a VCR may be very different than the settings for a high resolution computer output. When display adjustments are made, the new settings are automatically saved in one of the projector's setup memories.

There are three types of setup memories: Input, Recall, and Zone. All three memory types store the same parameters; the only difference is that Source memories store display settings for a particular physical input (e.g., slot 1, input 2) while Recall and Zone memories can be used with any input.

Setup memories store the following display parameters:

- | | |
|---|---|
| <input type="checkbox"/> BLANKING (T&B) | <input type="checkbox"/> HORIZONTAL HOLD |
| <input type="checkbox"/> BOW | <input type="checkbox"/> KEYSTONE |
| <input type="checkbox"/> BRIGHTNESS | <input type="checkbox"/> MOVE (H&V) |
| <input type="checkbox"/> COLOR | <input type="checkbox"/> PINCUSHION (T,B&S) |
| <input type="checkbox"/> CONTRAST | <input type="checkbox"/> SIZE (H&V) |
| <input type="checkbox"/> CONVERGENCE | <input type="checkbox"/> TINT |
| <input type="checkbox"/> DETAIL | <input type="checkbox"/> VERTICAL FREQUENCY |
| <input type="checkbox"/> FAST/SLOW SYNC | <input type="checkbox"/> VERTICAL HOLD |
| <input type="checkbox"/> FOCUS | <input type="checkbox"/> VOLUME |
| <input type="checkbox"/> HORIZONTAL FREQUENCY | |

At any one time, one setup memory is the *current setup memory*. The display settings in the current setup memory are used for the currently displayed image; one exception is when ASR is on and ASR has created a temporary memory for use. When a source is selected by entering its input number, the Source memory for the selected input becomes the current setup memory. If a Recall or Zone memory is selected, it becomes the current setup memory. Display adjustments are automatically saved in the setup memory which is current at the time of adjustment (unless the setup memory is locked or a temporary memory created by ASR is in use).

Source Memories ► As mentioned, Source memories store display settings for each physical input. When an input is selected, the Source memory for that input becomes the current setup memory and its display settings are used. The projector has forty eight Source memories.

Recall Memories ► Recall memories provide an alternative to using the display settings stored in the Source memory of the selected source. If there are many devices which will be sharing the same input, many Recall memories can be created to store the display settings for each. On the other hand, if there are many sources on different inputs with exactly the same signal characteristics, it may be possible for them to share the same Recall memory. The projector has ten Recall memories.



To select a Recall memory:

Press **SOURCE** **RECALL** **[n]**.

where: n = the Recall memory number (0 to 9)

For example, to select Recall memory 1, press **SOURCE** **RECALL** **[1]**. Recall memory 1 will then be the current setup memory and its settings will be used for the currently selected source. Any display adjustments you make will be stored in the Recall memory unless it is locked.

Zone Memories ► Zone memories are similar to Recall memories but provide an additional function — to maintain a database of display settings of five different input sources, each with a different horizontal frequency within the projector's input frequency band. Zone memories are sometimes interpolated or recalled to create new display settings when ASR is on or temporarily forced. The projector has five Zone memories.



Zone memories are primarily used by the ASR feature but may also be selected and used like Recall memories. To select a Zone memory:

Press **SOURCE** **#** **n**.

where: n = the Zone memory number (1 to 5)

For example, to select Zone memory 1, press **SOURCE** **#** **1**. Zone memory 1 will then be the current setup memory and its settings will be used for the currently selected source. Any display adjustments you make will be stored in the Zone memory unless it is locked.

**Locking Setup
Memories** ►
🔑

Setup memories may be locked or unlocked. Locking a setup memory prevents display setting adjustments from being saved in that memory. For example, if Recall memory 8 is locked and selected, then brightness is adjusted, the new brightness setting is only temporary. If the setup memory is then reselected, the original brightness setting will be restored.

Note: When a locked setup memory is selected, a key icon (🔑) is displayed in the Source Message.



To lock or unlock the current setup memory, press **SOURCE** **KEY**.

3.5 Display Adjustments

This section describes the projector's display adjustment functions. To access all display functions, a full function keypad such as the Built-in Keypad or standard IR Remote Keypad is required. If you are using the optional Presenter's Keypad, only the primary display functions are available. There are four types of display adjustment functions: Primary, Picture, Geometry, and Convergence.

- Primary display functions include Brightness, Contrast, Color, Tint and Detail.
- Picture functions are secondary display adjustment functions which include Vertical and Horizontal Hold, Fast/Slow Sync, Blanking, Move and Focus.
- Geometry functions are used to correct for geometric distortions of the image such as Size, Keystone, Pincushion and Bow.
- Convergence is used to align the red, green, and blue color components of the image. It is described in section 3.6, *Convergence Registration*.

For new images where much adjustment is required, it is recommended that adjustments be made using the sequence illustrated. Most adjustment functions, when selected, display a sidebar overlaid on the source image. The sidebar displays the current setting. The arrow keys are used to make adjustments. Adjustment settings are stored in the current setup memory (Input, Recall, or Zone). An exception is when the current setup memory is locked or a temporary memory created by ASR is in use. If locked, new adjustment settings are shown but they are not stored; they are discarded when another setup memory is selected.

**NORMAL
ADJUSTMENT
SEQUENCE**

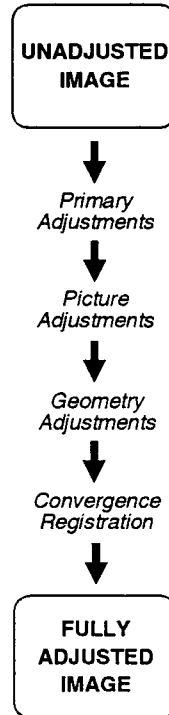

Primary Display Adjustments ►

Brightness

The Brightness function is used to adjust the overall light output of the projector.

To adjust brightness, press **[BRITE]** then **[▲]** or **[▼]**. If video or data is displayed with a black background, adjust until the background just disappears (black becomes a very dark grey).

Note: If room lighting changes, it may be necessary to re-adjust brightness.

Contrast

The Contrast function is used to adjust the contrast between the light and dark areas of the image.

To adjust contrast, press **[CONT]** then **[▲]** or **[▼]**. If contrast is set too high, the image loses detail and clarity. If set too low, it may be difficult to distinguish between foreground and background information.

Notes: 1) For best results, adjust brightness before contrast. 2) If projection room lighting changes, it may be necessary to re-adjust contrast and brightness.

Detail

The Detail function is used to adjust the sharpness of a video image when using the optional Multi-Standard Decoder input module.

To adjust detail, press **DETAIL** then **▲** or **▼** until the sharpest display is attained. Detail level should be roughly proportional to input signal quality. Higher levels of detail may enhance good quality signals. Lower levels of detail reduce noise in poor quality signals.

Color

The Color function is used to adjust color saturation in a video image when using the optional Multi-Standard Decoder input module.

To adjust color, press **COLOR** then **▲** or **▼** until the desired color saturation level is displayed. If Color is set to 0, the result will be a black and white image. If Color is set too high, the color levels in the image will be overpowering.

Tint

The Tint function is used to adjust color hue to obtain true color reproduction of an NTSC video image when using the optional Multi-Standard Decoder input module.

To adjust tint, press **TINT** then **▲** or **▼** until an optimum display is attained. It is best to adjust tint while displaying an image with natural flesh tones.

Note: Tint is not adjustable for PAL or SECAM sources.

Picture Functions ►

Vertical Hold

The Vertical Hold function is used to turn automatic vertical frequency locking on or off, or manually adjust the vertical synchronization frequency. The rear panel V. MANUAL light on the projector rear panel illuminates if manual mode is on.

To adjust vertical hold, press **V HOLD**. The slider displays the current locking mode (manual or auto) and the vertical locking frequency.

- 1) If automatic vertical frequency locking is on, you can switch to manual mode by pressing **V HOLD** once more. Use **▲** or **▼** to adjust the vertical frequency until the display is stable (vertically).
- 2) If automatic vertical frequency locking is off, a second press of **V HOLD** will turn automatic mode on.

Normally, users set the automatic vertical frequency locking feature to On. If the source signal is of low quality, the projector's automatic locking circuitry may have difficulty stabilizing to the required vertical hold frequency. It may then be required to manually adjust the vertical hold frequency.

Horizontal Hold

The Horizontal Hold function is used to turn automatic horizontal frequency locking on or off, or manually adjust the horizontal synchronization frequency. The rear panel H. MANUAL light on the projector rear panel illuminates if manual mode is on.

To adjust horizontal hold, press **[H HOLD]**. The slidebar displays the current locking mode (manual or auto) and the horizontal locking frequency.

- 1) If automatic horizontal frequency locking is on, you can switch to manual mode by pressing **[H HOLD]** once more. Use **[▲]** or **[▼]** to adjust the horizontal frequency until the display is stable (horizontally).
- 2) If automatic horizontal frequency locking is off, a second press of **[H HOLD]** will turn automatic mode on.

Normally, users set the automatic horizontal frequency locking feature to On. If the source signal is of low quality, the projector's automatic locking circuitry may have difficulty stabilizing to the required horizontal hold frequency. It may then be required to manually adjust the horizontal hold frequency.

Fast/Slow Sync

The Fast/Slow Sync function is used to minimize horizontal jittering, "flag waving" or tearing at the top of the image. This effect sometimes occurs when the source is a VCR or video signal. The function changes the synchronization mode of the projector from fast to slow, or slow to fast.

To switch between synchronization modes, press **[F SYNC]**. The new setting is briefly displayed at the lower right corner of the screen.

Vertical Blanking

- 1) The Vertical Blanking function is used to hide or black out unwanted information (or noise) at the top or bottom of the image. Blanking adjustments may be required when the source is a VCR or video signal.

To adjust vertical blanking, press **[V BLANK]** then **[▲]** or **[▼]** to adjust the amount of blanking at the top of the display screen. Press **[V BLANK]** again then **[▲]** or **[▼]** to adjust the amount of blanking at the bottom of the display screen.

- 2) The VBLANK key also allows you to turn on or off the red, green and/or blue color components of the image. To select the color components you want displayed, press **V BLANK** followed by a number (*n*). Refer to the chart below.

n	COLORS TURNED ON	n	COLORS TURNED ON
1	red	5	green-blue
2	green	6	red-blue
3	blue	7	none
4	red-green	8	all

To return the projector to normal operation, select 8 (above) or press **EXIT**.

Move

The Move function is used to move the image up, down, left or right within the image display area.

Use the Move function as follows:

Press **MOVE**. The sidebar displays NO MOVE, H MOVE, V MOVE or HV MOVE. If NO MOVE is displayed the projector's factory display position is active; otherwise, user-defined move settings are currently being used. Press **MOVE** to change sidebar displays.

With H MOVE displayed, **←** and **→** adjust horizontal position.
 With V MOVE displayed, **▲** and **▼** adjust vertical position.
 With HV MOVE displayed, **←**, **→**, **▲** and **▼** adjust both the horizontal and vertical position.

To de-activate the use of user defined position settings, select NO MOVE. The user defined H, V and HV settings will be stored but not used.

Focus

The Focus function is used to adjust the electrical focus of the combined red, green, and blue color components.

To adjust focus, press **FOCUS** then **▲** or **▼** until the center of the display appears the sharpest. If the displayed image cannot be adequately focused, a service adjustment to electrical focus or optical lens adjustment may be required. Contact your dealer or an authorized service technician for assistance.

Geometry ►
Functions

Size

The Size function is used to adjust the horizontal and vertical sizes of the image.

To adjust size, press **SIZE** then **▲**, **▼**, **◀** or **▶** until the objects within the image have the proper shape. For example, if there is a circle in the image, size should be adjusted so that the circle is round, not oval.

Note: The Size function should not be used to compensate for aspect ratio mismatches between source images and the projection screen. Not all sources use the same aspect ratio therefore it may not always be possible to fill the entire screen. ("Aspect Ratio" is defined in Appendix A).

Keystone

The Keystone function corrects for keystone geometry distortion. Adjust keystone if the width at the top of the display is not the same as the width at the bottom. For example, the images shown below require keystone adjustment.

To adjust keystone, press **KEY** then use **▲** and **▼** until the top and bottom widths of the image are equal.

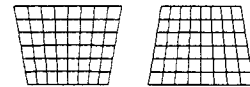

Pincushion

The Pincushion function corrects for curvature occurring at the sides and top of the image. For example, the six images shown below require pincushion adjustment.

To adjust pincushion, first press **PIN**. Use **▲** and **▼** until the top of the image is straight.

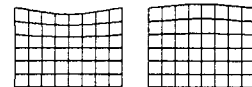

Press **PIN** again then use **▲** and **▼** until the bottom of the image is straight.

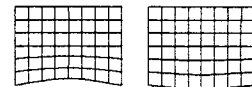

Use **◀** and **▶** until the vertical sides of the image are straight.

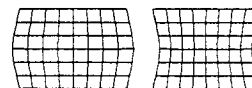

Bow

The Bow function corrects for curvature in the vertical direction in the middle of the image. For example, the images shown below require bow adjustment.

To adjust bow, press **BOW** then use **▲** and **▼** until the center of the image is straight.

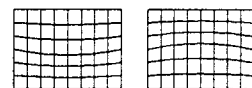

3.6 Convergence Registration

Convergence Registration is the process of aligning the red, green, and blue color components on the projection screen. The projector's convergence system provides accurate color registration in 45 discrete convergence zones configured in a 9 (horizontal) by 5 (vertical) array on the projection screen. Since the projector must converge colors differently for each source (due to varying scan frequencies), convergence settings are saved for each input. Convergence settings can also be saved in Recall memories and Zone memories.

There are three basic convergence methods available: Guided, Interpolated, and Random Access. Any one of these can be selected for performing a registration adjustment. All are easy to use and context-sensitive help is available if needed. If the projector includes the optional ACON feature, the convergence process is completely automated. ACON is recommended in situations where fast, accurate convergence must be performed, or when many inputs must be converged, or when the projector installation position frequently changes.



To perform a convergence:

Begin by selecting the input source to be converged. Convergence settings will be saved in the current setup memory (unless it is locked or a temporary memory created by ASR is in effect). Next, press **CONV** to display the Convergence menu. Select one of the convergence options.

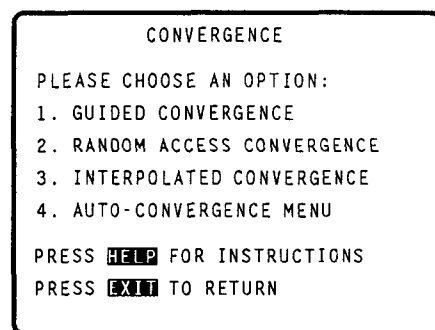

Guided Convergence provides a complete guided procedure for converging the red and blue images onto the green image in all 45 convergence zones. Use this option if the image requires minor convergence alignment.

Random Access Convergence allows you to converge a particular area of the display. Any zone may be quickly selected and converged. This option also allows convergence of the blue on the red image (if preferred to the normal blue on green).

Interpolated Convergence provides a complete convergence procedure similar to Guided Convergence but is recommended when the image requires major convergence alignment.



ACON is an optional feature which provides fast, accurate automatic convergence in all 45 convergence zones. Minimal user intervention is required. If the projector does not include ACON, item 4 in the menu reads: ACON NOT AVAILABLE.

The following options are available while performing any of the manual convergence routines:

Convergence on Image

When a convergence method is first selected, an internally generated crosshatch test pattern is displayed. You may use the crosshatch while adjusting convergence or instead choose to view the external image. Press **#** to toggle between the crosshatch and the external image.

Convergence Reset

If you want to reset all convergence settings during a convergence routine, press **0**.

Note: Allow the projector to warm up for at least forty five minutes prior to convergence registration.

Guided Convergence ►

Press **1** from the Convergence menu to select Guided Convergence. An internally generated crosshatch is displayed for the alignment. Initially, a red and green crosshatch is displayed and a rectangular box surrounds the center convergence zone. Use **▲**, **▼**, **◀**, and **▶** to move the red onto the green in the zone. Press **CONV** then move the blue onto the green in a similar manner. These first two adjustments adjust the position of the red and blue images with respect to the green over the entire screen (static convergence). The adjustments to follow (dynamic convergence), modify color positioning within individual zones.

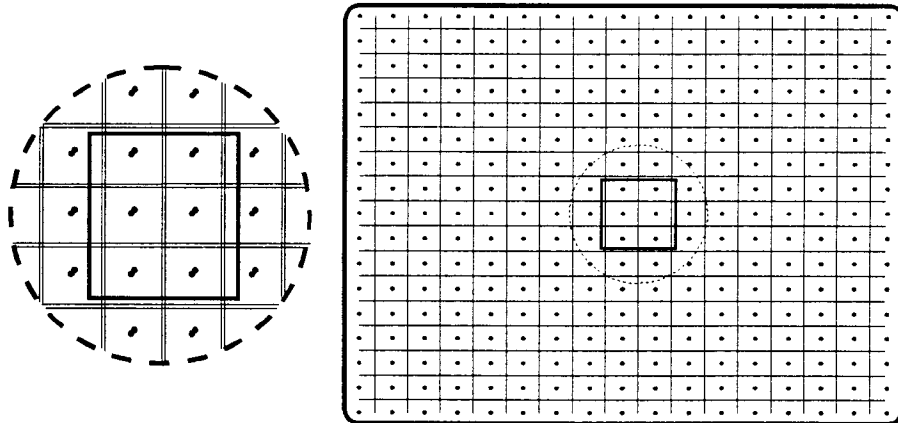

Press **CONV** to move the rectangular box to the next convergence zone. Again, use the arrow keys to align the red onto the green. Press **CONV**, then align the blue onto the green.

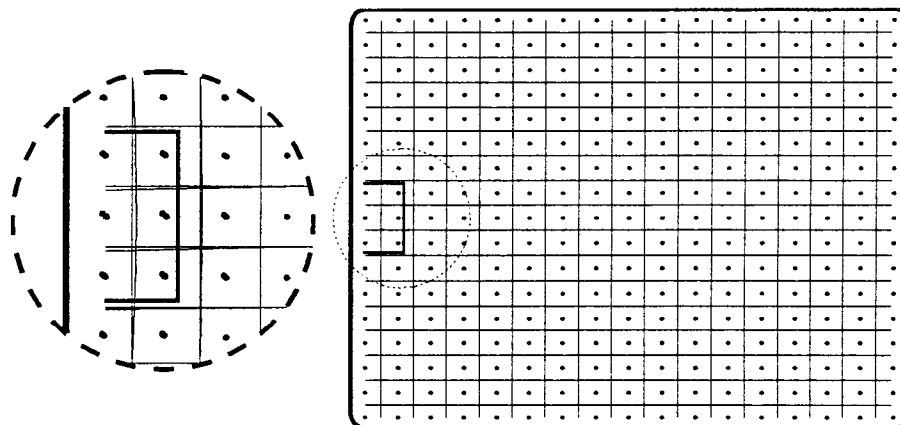

Within each zone, a central control point defines the position of each color within the zone. Notice that the center position within the box is most sensitive to the adjustment. This is where the control point is located. Continue using **CONV** to move to the next zone/color for adjustment. To go back to a previous zone, press *****. Once all 45 zones have been converged an Exit confirmation screen is displayed, as shown below. To exit prior to converging all 45 zones, press **EXIT** which will immediately display the Exit confirmation screen.

When the Exit confirmation screen is displayed, press **EXIT** to save the new convergence settings and exit Guided Convergence. Alternatively, to go back to the convergence routine, press **CONV**. To discard your changes, press **0**.

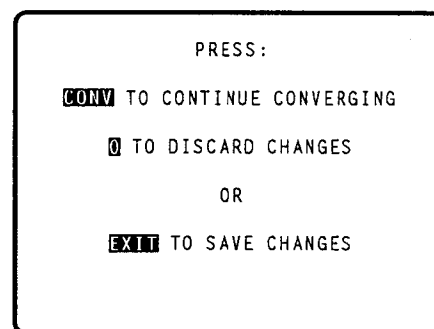

Random Access Convergence ►

Press **2** from the Convergence menu to select Random Access Convergence. A red and green crosshatch is displayed with a rectangular box at the center zone. Above the box, CONV indicates that the zone is ready for convergence. Use the arrow keys to move the red onto the green within the box. This affects the position of the red with respect to the green over the entire screen (static convergence).

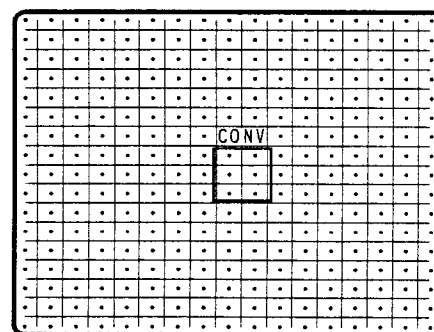

To change the convergence color, press **COLOR**. Each press of the Color key changes the color as shown.

SEQUENCE	REFERENCE COLOR	CONVERGENCE COLOR
1. COLOR	green	blue
2. COLOR again	red	blue
3. COLOR again	a white crosshatch for reference	
4. COLOR again	repeat starting at green-red	

To move to another control point, press **[MOVE]**. The caption above the box changes to MOVE. Use the arrow keys to move to another convergence zone. Press **[CONV]** to converge the zone. When all zones requiring adjustment are converged, press **[EXIT]** to display the Exit confirmation screen. Press **[EXIT]** to save the new convergence settings. Alternatively, to go back to the convergence screen, press **[CONV]**. To discard your changes, press **[0]**.

Interpolated Convergence ►

Press **[3]** from the Convergence menu to select Interpolated Convergence. Interpolated Convergence is performed in the same way as that described for Guided convergence. The primary difference between Guided Convergence and Interpolated Convergence is noticed during adjustment. In Interpolated Convergence, adjustments are not limited to single zones, but will affect larger regions of the raster. Response is greatest within the displayed box. Interpolated Convergence is recommended when converging a source for the first time, since it can be much faster than Guided Convergence. However, it is not recommended if only minor convergence alignment is required.

ACON Automatic Convergence ►



Press **[4]** from the Convergence menu to display the ACON Auto-Convergence menu. The menu displays five ACON options for selection, and shows the most recent ACON status number (if there is one). The version of the internal ACON Control Board is also displayed.

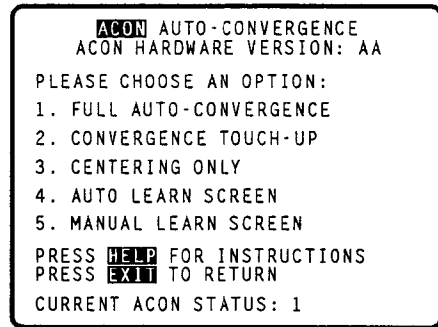
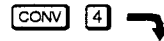

Note: The ACON Auto-Convergence menu is available only if the projector includes the optional ACON feature.

Before using ACON for the first time it is important to understand how ACON operates. ACON consists of two primary components; a Locator Assembly, normally mounted to the front of the projector, and an ACON Control Board, located inside the projector. The Locator Assembly includes a photosensor which, via two stepper motors, can monitor any point on the display screen. The ACON Control Board controls the aiming of the photosensor and reads the signals from it. During automatic convergence, small red, green, and blue targets are displayed for viewing by the photosensor. Data from the photosensor is analyzed and convergence adjustments are made accordingly. The lens of the Locator Assembly can be observed to move about as each convergence zone is analyzed and adjusted. No user intervention is required.

Note: Please read this entire sub-section prior to performing an automatic convergence.

Warning: In rare instances, flashing lights can trigger an epileptic seizure. During ACON operation persons with epilepsy should not watch the screen.

Automatic Convergence - Full, Touch-up, and Center Only

Options 1, 2 and 3 in the ACON Auto-Convergence menu provide selection of three automatic convergence routines: Full Auto-Convergence, Convergence Touch-Up, and Centering Only. If the image has never been converged or is poorly converged, select option 1, Full Auto-Convergence. If the image has been previously converged and only minor touch-up is required, select option 2, Convergence Touch-up. If the red or blue image has shifted position and is not registered with the green, select option 3, Centering Only.

Note: It is important to have a good lighting environment when using ACON. Dimmed incandescent lighting is preferred over fluorescent lighting. Avoid shadows on the screen.

When Full Auto-Convergence is selected, ACON converges the red and blue to the green at all 45 convergence zones. As each zone is converged, surrounding zones are also adjusted. Full Auto-Convergence provides fast, accurate convergence adjustment of poorly converged images. During automatic convergence you will notice a small red, green, or blue square briefly displayed at each zone location. It is at that time that ACON is analyzing and adjusting the convergence. Full automatic convergence takes approximately three minutes to complete.

Convergence Touch-up also converges at all 45 convergence zones. It is different than Full Auto-Convergence in that as each zone is converged, surrounding zones are not affected. It is faster than full auto-convergence and provides a good convergence alignment when minor convergence adjustment is required.

When Centering Only is selected, the full red and blue image positions are adjusted based on the misconvergence with respect to the green at the center of the display.

At the beginning of each auto-convergence routine, ACON calibrates the position of the lens/photosensor assembly. The screen displays HOMING THE MOTORS, PLEASE WAIT. Shortly thereafter, the projector memory is checked for screen position data saved from a previous Learn Screen. If screen position data does not exist, a Learn Screen is automatically performed. From this point on, throughout the remainder of the convergence process, you will notice a small square flashing on the screen. This is normal.

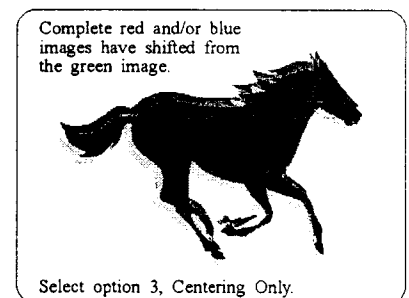
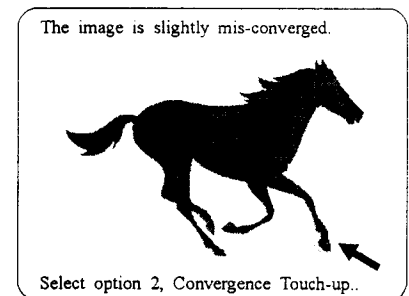
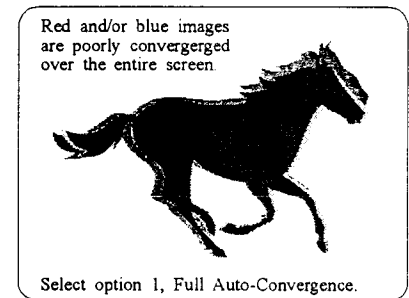

When convergence is complete, a save/discard confirmation screen is displayed. To save the new convergence settings, press **EXIT**. To discard the changes, press **0**.

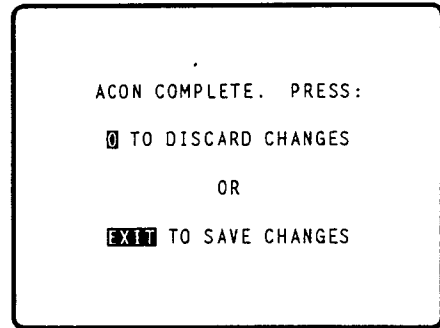

Learn Screen - Auto, Manual

Options 4 and 5 in the ACON Auto-Convergence menu allow you to perform an ACON Learn Screen.

A Learn Screen operation must be performed at least once for each new installation so that ACON knows the exact screen position relative to the Locator Assembly. A Learn Screen **MUST** be performed when one of the following conditions exist:

- The projector-to-screen distance has changed since the last Learn Screen.
- The ACON Locator Assembly mounting position has changed since the last time Learn Screen was performed.
- The screen type or size has changed.
- ACON is newly installed.
- The projector's software was reset by a dealer or a service technician.

Before performing a Learn Screen, make sure the projector is fully set up and adjusted for the installation. It is important that all focus and geometry adjustments have been made.

Two Learn Screen options are available: Manual Learn Screen and Auto Learn Screen. Manual Learn Screen (menu option 5) is the preferred method for performing a Learn Screen; it requires some user assistance but assures the best possible results. Auto Learn Screen, which requires no user assistance, works well in installations where ACON can easily determine the screen limits. The screen limits may be difficult for ACON to determine if the installation is a rear screen, the ambient light conditions are poor, or the top of the screen meets the ceiling. If an Auto Learn Screen was used but ACON had difficulty determining the screen limits, the quality of subsequent convergences will be affected — especially near the screen edges and corners. Until you have experience using ACON for the installation, it is recommended that Manual Learn Screen be used.

When Manual Learn Screen is selected, two vertical and two horizontal bars are displayed as shown. Adjust the position of each bar by pressing the appropriate number key, followed by an arrow key. The bar selected is indicated at the bottom of the screen. Each press of an arrow key moves the bar one position (50% of bar width). Adjust each bar until the distance between the screen edge and the bar's outside edge is one bar width.

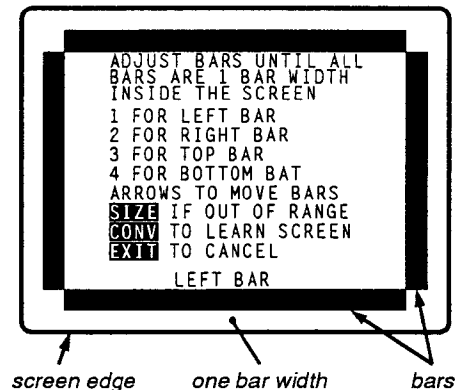

If you cannot adjust the bars as required, use the Size function to re-adjust the display size. If bar positions can still not be adjusted as required, the projector may not have been installed or set up correctly. Press **EXIT** to cancel.

When all bars have been adjusted, press **CONV** to continue with the Learn Screen operation. The remainder of the Learn Screen process is handled automatically by ACON.

Error Messages

If ACON encounters a problem which it cannot resolve, processing halts and an error screen is displayed. The error screen displays an error code which identifies the type of error which has occurred.

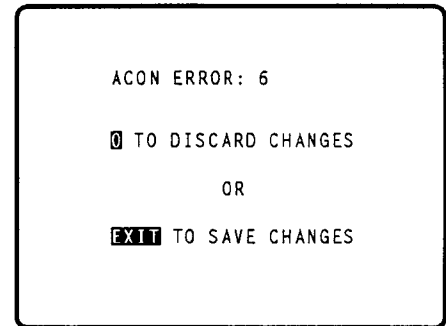

The projector waits for a response from the user. Press **0** to discard new data created during the latest auto-convergence routine. To save the data, press **EXIT**. Since the data is usually not useful, due to the error, it is recommended that the new data be discarded. The Auto-Convergence menu retains and displays the error code until the routine which identified the error is performed successfully. When no errors exist, the "current ACON status" in the menu displays a "1". ACON error codes are listed in Table 3-1.

ACON errors are usually caused by one of the following:

- the Locator Assembly view is obstructed
- the ambient room lighting is too bright
- an ACON routine was aborted by the user (EXIT or POWER key pressed)
- Learn Screen must be performed

Table 3-1. ACON Error Codes

#	DESCRIPTION
1	No Errors - ACON status OK.
4	Too many attempts to move the red or blue to the green target.
5	Cannot convergence the red or blue color to the green target. Green target out of range.
6	Insufficient red or blue target signal.
7	Red or blue signal too bright.
11	Too many attempts to move the photosensor to the green target.
12	Low Target Signal - Cannot lock photosensor on green target due to low target signal.
13	High Target Signal - Cannot lock photosensor on green target due to high target signal.
14	Sensor Lock Out of Range - Photosensor cannot see entire screen.
21	Sensor Lock Error - Could not find a point during convergence spiral search.
23	ACON Aborted - Current ACON routine aborted by user.
24	Targets Outside Boundaries - An entire row of targets is outside the Learn Screen boundaries.
25	General Failure - ACON may not be providing optimum convergence accuracy.
31	Sensor Lock Accuracy Questionable - Too many varied readings.
34	Cannot Pinpoint Target - Target is detected but signal is too low during spiral search.
40	Learn Screen Aborted - Learn Screen aborted by user (EXIT or POWER key pressed).
41	Horizontal Position Out Of Range - During Learn Screen, photosensor reached physical horizontal limits.
42	Vertical Position Out Of Range - During Learn Screen, photosensor reached physical vertical limits.
45	Insufficient target signal (during Learn Screen).
46	Signal too bright (during Learn Screen).

3.7 Utility Features

The projector's utility features allow you to customize operation of the projector to suit your application and preferences. To access these features, press **HELP** **5**. The Utilities menu is displayed.

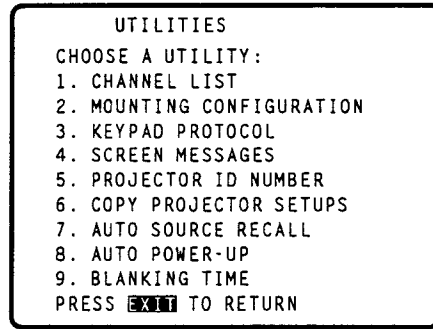
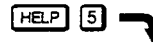

Item 1, Channel List, allows sources to be assigned to two digit channel numbers.

Item 2, Mounting Configuration, allows you to set the directional response of the arrow keys to match the current mounting configuration.

Item 3, Keypad Protocol, is used to set the projector's keypad protocol setting to match the protocol type of the remote keypad(s).

Item 4, Screen Messages, allows you to enable or disable the display of slidebars and status displays.

Item 5, Projector ID Number, is used to change the projector's identity number.

Item 6, Copy Projector Setups, allows you to copy stored display settings from one setup memory to another.

Item 7, Auto Source Recall, is used to enable or disable the Auto Source Recall (ASR) feature.

Item 8, Auto Power-up, lets you enable or disable the Auto Power-up feature.

Item 9, Blanking Time, is used to set the length of time to blank the screen during source switching.

Channel List ►

The Channel List utility allows you to display and program the projector's Channel List. The Channel List is a user-programmable list of sources and projector setups. A source defined in the list can be quickly selected and displayed by entering its assigned two-digit channel number. Channels can also be selected using the keypad's up and down arrow keys. Channel selection is described in section 3.3, *Source Selection*.

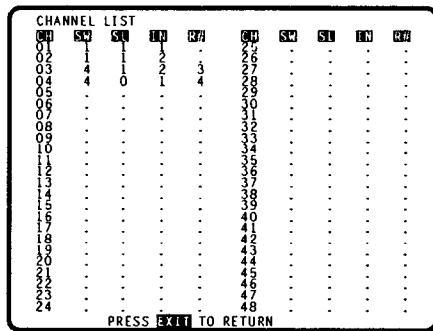

To display and/or program the Channel List, press **[1]** from the Utilities menu. A total of 48 channel data sets are displayed in two columns. Each data set includes:

- CH** Channel Number (from 01 to 48).
- SW** Switcher Number (from 1 to 4). A period (.) indicates no switcher.
- SL** Slot Number. The slot number should be 0 or 1 if no switchers are used. If a switcher is used, the slot number can be from 1 to 6.
- IN** Input Number (1 or 2).
- R#** Recall Memory Number (0 to 9).

A period (.) in any field position indicates an unspecified or null value.



To program a channel, use **[▲]**, **[▼]**, **[◀]** and **[▶]** to move the cursor to the channel to be programmed. Under the **SW** column, enter the switcher number if switcher selection is required. Press **[*]** if no switcher is used or only a single switcher is connected through an RGB 10 Pin Input module. Under the **SL** column, enter the source slot of the projector or switcher. Under the **IN** column, enter the input number (1 or 2) of the slot. Lastly, if a Recall memory is to be used, enter the Recall memory number (0 to 9) in the **R#** column.

Use the cursor keys to move to another channel or press **[EXIT]** to leave the Channel List. To clear a number to an unspecified value (.), press **[*]**.

*Notes: 1) Channels should contain valid inputs. For example, do not specify switcher 2 if switcher 2 does not exist in the system. 2) To clear ALL Channel List settings, hold down **[RESET]** for one second.*

Mounting Configuration

The Mounting Configuration utility is used to set the directional response of the keypad's arrow keys. The Mounting Configuration setting should match the physical mounting configuration of the projector. If set incorrectly, the arrow keys may not respond as expected. For example, the response of the **[◀]** and **[▶]** keys will be reversed if the projector is ceiling mounted but the setting is for a floor mount (upright) installation.

[HELP] **[5]** **[2]**

```

MOUNTING CONFIGURATION
1. UPRIGHT ON FRONT SCREEN
  H - NORMAL, V - NORMAL
2. INVERTED ON FRONT SCREEN
  H - REV., V - REV.
3. UPRIGHT ON REAR SCREEN
  H - REV., V - NORMAL
4. INVERTED ON REAR SCREEN
  H - NORMAL, V - REV.
CURRENT SETTING IS:
  UPRIGHT ON FRONT SCREEN
PRESS [HELP] FOR INSTRUCTIONS
PRESS [EXIT] TO RETURN
  
```



Press **[2]** from the Utilities menu to display the Mounting Configuration setup screen. Press **[1]** if the projector is installed upright in front of the screen. Press **[2]** if the projector is ceiling mounted (up-side-down) in front of the screen. Press **[3]** if the projector is installed upright behind the screen. Press **[4]** if the projector is ceiling mounted (up-side-down) behind the screen. For rear screen installations where a mirror is used with an upright projector to fold the optical path, use selection 1. If a two mirror rear screen box is used with an upright projector, use selection 3. Press **[EXIT]** when done.

Note: These settings do not affect the video scan direction. To reverse the horizontal or vertical scan direction, contact your dealer or an authorized service technician.

Keypad Protocol ▶

Keypad protocols allow two projectors in the same room to be independently controlled by separate remote keypads. The projector can accept one of two different keypad transmission protocols: One or Two. The default protocol setting is One, which matches the protocol of the IR keypad supplied with the projector. If an optional Protocol 2 remote keypad is to be used with the projector, the protocol selection in the Keypad Options selection box must be set to Two.

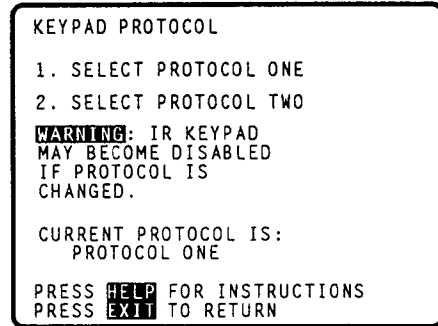

Press **3** from the Utilities menu to display the Keypad Protocol setup screen. Press **1** if the projector is to be controlled by a Protocol 1 keypad, or press **2** for control by a Protocol 2 keypad. Press **EXIT** when done.

Notes: 1) The protocol setting is only important for infrared remote (IR) or wired remote keypad use. The setting has no effect on the use of the built-in keypad. 2) If you incorrectly modify the IR protocol setting you may have to use the built-in or a wired remote keypad to correct the setting.

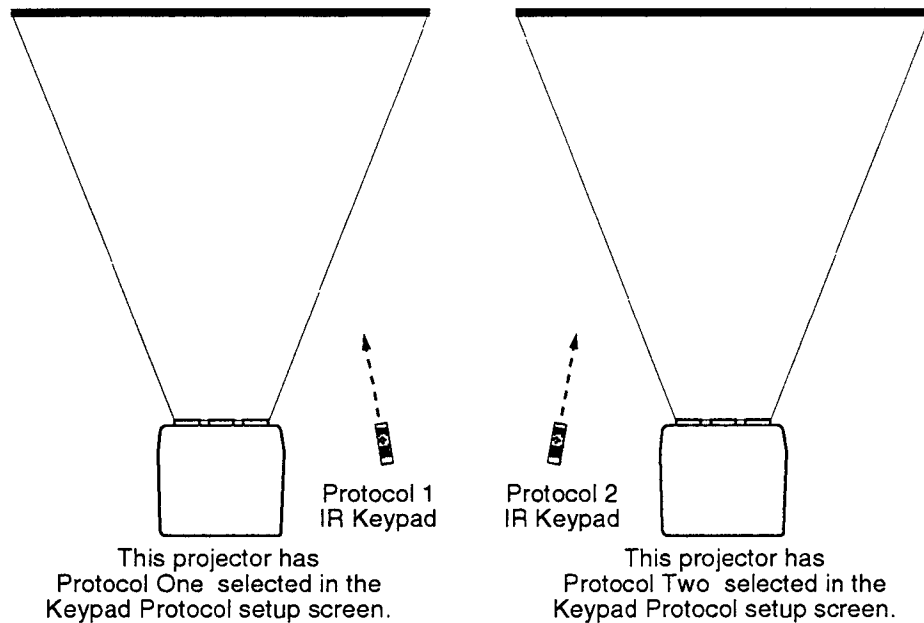

Figure 3-7. Independent IR Keypad Control

Screen Messages ➤ The Screen Messages utility allows you to choose whether screen messages will be displayed. Screen messages include slidebars and status messages. For most applications it is recommended that Screen Messages be set to On. However, if during a presentation you want to make subtle display adjustments without drawing attention to your actions, Screen Messages should be set to Off.

HELP 5 4 ➤

```

SCREEN MESSAGES
1. TURN SCREEN MESSAGES ON
2. TURN SCREEN MESSAGES OFF

SCREEN MESSAGES
ARE CURRENTLY:

ENABLED

PRESS HELP FOR INSTRUCTIONS
PRESS EXIT TO RETURN

```



Press 4 from the Utilities menu to display the Screen Messages setup screen. Press 1 to enable messages display. Press 2 to disable the display of messages. Press EXIT when done.

Note: It is still possible to display a screen message, such as a slidebar, while Screen Messages is set to Off. To do this, press RECALL just prior to selecting the function; for example RECALL CONT displays the contrast slidebar.

Projector ID Number ➤ The projector's identification number allows IR remote control of a single projector in a multi-projector installation.

HELP 5 5 ➤

```

PROJECTOR ID NUMBER
ENTER PROJECTOR ID NUMBER
USING THE BUILT-IN
KEYPAD.

CURRENT NUMBER IS:
000

PRESS HELP FOR INSTRUCTIONS
PRESS EXIT TO RETURN

```



Press 5 from the Utilities menu to display the Projector ID Number setup screen. Using the built-in keypad, enter a three digit ID number. If there is only one projector in the installation, "000" is the recommended ID number. Press EXIT when done.

For information about multi-projector control, refer to section 3.8, *Multi-projector Functions*.

Note: The projector ID cannot be entered from the IR Remote Keypad.

Copy Projector Setups ➤ The Copy Projector Setups utility is used to copy stored display settings from one setup memory to another. When a copy is made, the originating memory remains unchanged and the destination memory is overwritten with the settings of the originating memory.

HELP 5 6 ➤

```

COPY PROJECTOR SETUPS
1. FROM : 01
2. TO   : R4
3. DO IT

PRESS HELP FOR INSTRUCTIONS
PRESS EXIT TO RETURN

```



Press 6 from the Utilities menu to display the setup screen. Press 1 to enter the setup memory you want to copy from. Press 2 to enter the setup

memory you want to copy to. You may copy from any Source, Recall or Zone memory. You may copy to any Source, Recall or Zone memory which is not locked.

To enter a Source memory, enter the slot number and input number. If a switcher is actively in use, the slot and input number refer to the switcher slot and input number. *Note: "01" refers to slot 0, input 1; not channel 01.*

To enter a Recall memory, press **[RECALL]** followed by a number between 0 and 9.

To enter a Zone memory, press **[#]** (zone) followed by a number between 1 and 5.

Once the from/to entries are complete, press **[3]** to proceed with the copy. The full contents of the originating setup memory are copied to the destination setup memory. This includes all display parameter information and scan frequency data. The previous contents of the destination memory are lost. Press **[EXIT]** when finished.

Tip: To clear a setup memory, simply copy a blank memory to the memory you want to clear.

Auto Source Recall (ASR) ►

The ASR feature provides automatic selection or interpolation of memory settings for the current source when the ASR utility is set to On.



Press **[7]** from the Utilities menu to display the ASR setup screen. The screen displays the current ASR setting. Press **[1]** to turn ASR on. Press **[2]** to turn ASR off. Press **[EXIT]** when done.

[HELP] **[5]** **[7]** →

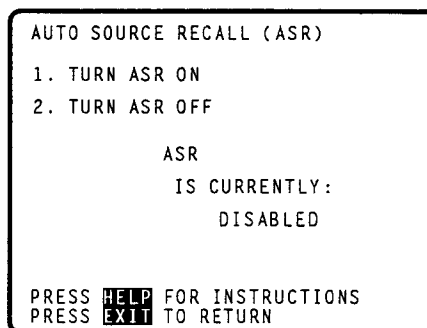

When ASR is On, the projector monitors the currently selected input for horizontal and vertical scan frequency changes. When a frequency change occurs, ASR attempts to adjust the current display settings to provide the best image for the new input. The settings may be a copy of a Recall, Input or Zone memory with matching scan frequencies, or new settings created by interpolating between the settings of two Zone memories. The logic used by ASR is illustrated in the ASR Logic Diagram in Appendix C.

ASR is also performed when:

- You select an input using the keypad while ASR is On.
- You select a Recall memory while ASR is On.
- A channel is selected while ASR is ON.

Note: For special notes and exceptions about ASR logic and control, refer to Appendix C, ASR Reference.

ASR is primarily intended for users who operate their projector with many different and changing inputs where frequent switching and adjustment of setup memories is required. For these users, ASR may significantly reduce display adjustment time as well as enhance system operation when using external (third party) switching equipment or devices. Consider using ASR when:

- many different sources share the same input cable
- when sources are switched without communication to the projector (via third-party switchers, etc.)
- the input source signal frequency may vary or change (such as a PC switching VGA modes)

ASR does not change the current setup memory, it only uses the display settings of other memories to create new settings to use with the current source. The new settings are stored in a temporary memory. When a new setup memory is selected, or the current setup memory is reselected, the settings in the temporary memory are discarded.

Note: To force the storage of the display settings created by ASR into the current setup memory, perform a "forced ASR" as described below.

ASR Source Message

To determine the action taken by ASR on the current source, press **SOURCE** to display the source status message (explained in section 3.3, *Source Selection*). Here are some examples of various ASR source messages:

If the display settings in Recall memory 4 were selected, the source display would include: ASR RCL 4.

If the display settings in Zone memory 2 were selected, the source display would include: ASR ZONE 2.

If the display settings of the Source memory were selected, the source display would include: ASR SOURCE.

If the new display settings were created by interpolating the settings in Zone memories 3 and 4, the source display would include: ASR Z3-Z4.

If no Recall or Zone memories met the conditions for use and a Zone memory interpolation could not be performed, the source display would include: ASR NO INT.

Forced ASR

Some users might not want ASR on all the time but would like to take advantage of ASR's recall and interpolation capabilities on demand. For example, if a new source is connected and considerable adjustment is required, you might want to "force" an ASR to have the current display settings automatically adjusted. After performing a "forced ASR", only minor display adjustments may be required.



To force an ASR on the current source, press **[SOURCE]** then hold down **[▶]** for one second. ASR uses the same logic as that used when ASR is turned on. However, the new settings will be stored in the current setup memory. If you decide you do not want the new settings, press **[SOURCE]** then hold down **[◀]** for one second; the source status display briefly flashes and the previous settings are returned.

Frequency Stamping

When ASR selects other setup memories for use, it bases its selections on the scan frequencies which relate to those memories. Unlike adjustable display parameters, the horizontal and vertical scan frequencies of the active input are not automatically stored in the setup memory. In order for ASR to use other memories these memories must be "frequency stamped".



To frequency stamp the current setup memory with scan frequency information, press **[SOURCE]** **[RESET]**. The current display parameters are (again) stored in the setup memory.

ASR Example

A system has six different sources as shown in Figure 3-8.

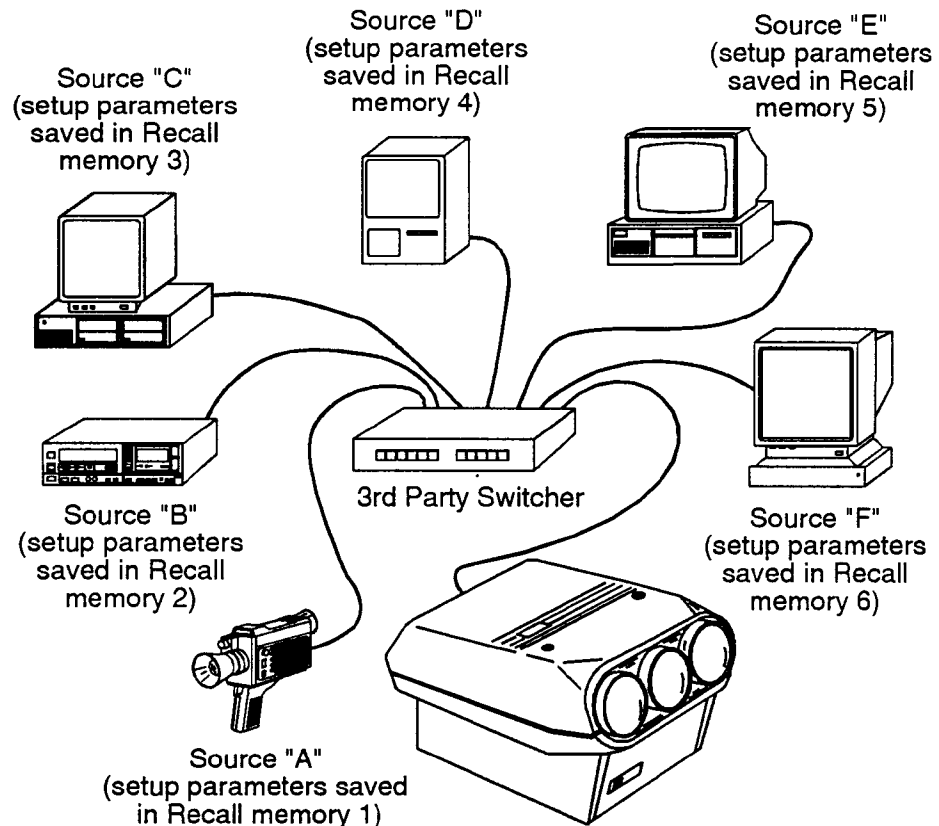

Figure 3-8. An Installation using the ASR Feature

Source "A" is a video camera. Source "B" is a VCR. Sources "C" through "F" are various computers. All sources are connected to a 3rd party (non-Electrohome) signal switcher. The switcher is connected to slot 1, input 1 of the projector. For each source, a Recall memory is created to store its display settings. No two sources have the same frequencies.

HELP **5** **7** is pressed to turn on the ASR feature. When a source is selected by the switcher, the projector automatically adjusts its display settings for the new source by switching to the Recall memory previously set up for that source.

Auto Power-up ►

If Auto Power-up is set to On, the projector automatically powers itself up when line power is removed then re-applied. For example, if power is temporarily interrupted due to a blackout, the projector will automatically power itself back up when power returns. If Auto Power-up were set to Off, the projector would require a manual power-on.

HELP **5** **8** ➔

```

AUTO POWER-UP
1. TURN AUTO POWER-UP ON
2. TURN AUTO POWER-UP OFF

AUTO POWER-UP
IS CURRENTLY:
DISABLED

PRESS HELP FOR INSTRUCTIONS
PRESS EXIT TO RETURN
  
```



Press **8** from the Utilities menu to display the Auto Power-Up setup screen. Press **1** to turn the Auto Power-up feature on. Press **2** to turn the Auto Power-up feature off. Press **EXIT** when finished.

Note: Upon automatic power-up, the most recent display adjustments may be lost if they were not yet saved in the current setup memory.

Blanking Time ►

When a source is selected, the projector must first switch-out the current source then switch-in the new source with the display settings of the specified Source, Recall or Zone memory. This can take a few seconds to complete, during which time the display may be unappealing for audience viewing. By setting the blanking time larger than the time required to process the switch, a "clean" transition is displayed.

HELP **5** **9** ➔

```

BLANKING TIME

YOU MAY SET THE NUMBER
OF SECONDS THAT THE
SCREEN IS BLANKED
WHEN SWITCHING SOURCES

PRESS A NUMBER KEY
BETWEEN 0 AND 5
THE CURRENT SETTING IS:

3 SECONDS

PRESS HELP FOR INSTRUCTIONS
PRESS EXIT TO RETURN
  
```



Press **9** from the Utilities menu to display the Blanking Time setup screen. Enter the blanking time (in seconds) from 0 to 5. The default blanking time is 3 seconds. If it is noticed that after 3 seconds the "switched-in" source is not ready for display, increase the blanking time. To disable blanking entirely, set the blanking time to 0.

3.8 Multi-projector Functions

In a multi-projector installation, it is usually desired to have one keypad control all projectors in the system. A single IR Remote keypad may be used if all projectors are in IR viewing range of the keypad. A single Wired Remote Keypad may be used if all projectors are serial linked and installed as described in section 2.7, *Serial Port Connections*. This section explains the special control functions available for such installations.

The Projector Function ►

The Projector function allows you to select which projector in a group will respond to remote keypad commands. To use this function, each projector in the installation must first be assigned a unique projector number. Projector numbers are assigned through the Projector ID Number setup screen which is accessed by pressing **HELP** **5** **5** on the built-in keypad. Once each projector has its own unique projector number, projectors in the installation can be individually controlled using the same remote keypad.



The projector ID number and listening status is displayed on the screen by pressing **PROJ**. To select a particular projector for control by the remote keypad, press **PROJ** then the projector's three digit identity number. To enable all projectors to listen to the remote keypad, press **PROJ** **EXIT**. If you only press **PROJ**, no changes are made and the projector status display disappears within a few seconds.

Maintenance

4.1 Warnings and Guidelines

The ECP Series projection system is CSA approved and is designed for safe and reliable operation. However, safe operation cannot simply be assured by design; installers, maintainers, and users must maintain a safe operating environment for the system. This section covers warnings and guidelines which promote the safe usage of the projector. Please read through and understand these warnings and guidelines.

Labels and Markings ►

Observe and follow all warnings and instructions marked on the projector.

The exclamation point within the equilateral triangle is intended to alert the user to the presence of important operating and maintenance (servicing) instructions in the literature accompanying the projector.



The lightning flash with arrowhead symbol, within the equilateral triangle is intended to alert the user to the presence of uninsulated "dangerous voltage" within the projector's enclosure that may be of sufficient magnitude to constitute a risk of electric shock to persons.



Projector Location ►

Operate the projector in an environment which meets the operating range specifications in Section 5. Do not operate the projector close to water — for example, near a swimming pool.

Do not place the projector on an unstable cart, stand or table. If the projector is to be ceiling mounted, only use an Electrohome approved ceiling mount fixture.

The projector and cart combination should be used with care. Quick stops, excessive force, and uneven surfaces may cause the projector and cart combination to overturn.



Power Cord and Attachments ►

Only use attachments or accessories recommended by Electrohome. Use of others may result in the risk of fire, shock or personal injury, and may void the warranty.

Do not allow anything to rest on the power cord. Locate the projector where the cord cannot be abused by persons walking on it or objects rolling over it.

Operate the projector at the voltage indicated on the line voltage indicator. Do not overload power outlets and extension cords as this can result in fire or shock hazards.

The projector is equipped with a three wire plug having a third (grounding) pin. **This is a safety feature.** If you are unable to insert the plug into the outlet, contact an electrician to have the outlet replaced. Do not defeat the safety purpose of the grounding-type plug.

Ventilation Slots ►

Slots and openings in the projector provide ventilation. To ensure reliable operation of the projector and to prevent overheating, these openings must never be blocked or covered. The projector should never be placed near or over a radiator or heat register. The projector should not be placed in an enclosure unless proper ventilation is provided.

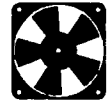

Do not push objects of any kind into the projector through the ventilation openings. They may touch dangerous voltages or short-out components resulting in a fire or shock hazard. Do not spill liquids of any kind into the projector. Should an accidental spill occur, immediately unplug the projector and have it serviced by a qualified service technician.

Servicing ►

If any of the following conditions exist, unplug the projector from the power outlet and refer service to qualified service personnel.

- The power cord has been damaged.
- Liquid has been spilled into the projector.
- The projector has been exposed to excessive moisture.
- The projector does not operate normally.
- The projector has been dropped or the case has been damaged.
- Projector performance has deteriorated.

Do not attempt to service the projector yourself. All servicing must be performed by a qualified Electrohome service technician. If replacement parts are required, it is important that only Electrohome approved parts are used. Other parts may result in fire, electric shock or risk of personal injury.

WARNING: The projector is internally shielded to protect the user from exposure to soft x-ray radiation. Improper servicing or shield removal may result in personal injury.



In rare instances, flashing lights can trigger an epileptic seizure. During ACON usage persons with epilepsy should look away from the screen.

4.2 Cleaning

Clean the projector when required. Before cleaning, always unplug the projector from the power outlet.

Lens Cleaning ► To avoid the risk of scratching the lenses, only clean the lenses if absolutely required. A small amount of dust on the lenses will have very little effect on picture quality. If the lenses must be cleaned, use a DRY soft cotton cloth. Rub gently in a circular motion.

Case Cleaning ► Clean the case with a soft dampened cloth. Use a mild commercial cleaner. Do not use liquid or aerosol cleaners.

ACON Cleaning ► The lens on the ACON Locator Assembly is very tolerant to dust and should only be cleaned if ACON performance is affected. Cleaning of the lens (if required) must be performed with great care. Use a DRY soft cotton cloth. Rub gently in a circular motion.



4.3 Troubleshooting

If the projector is not operating properly, note the symptoms of the problem and use the following guide to assist you. If you cannot resolve the problem yourself, contact your dealer for assistance.

Projector Response Problems

Refer to the following if the projector is not responding to keypad commands.

Symptom: The projector will not turn on when **POWER** is pressed.

Cause/Remedy:

- 1) The power cord may be disconnected. Check the power cord connection at the wall outlet and at the projector.
- 2) Power is not available at the wall outlet.
- 3) The projector's AC line input unit is not configured correctly. See section 2.5, *Power Connection*.
- 4) **POWER** may not have been held down long enough to initiate projector power-up. Hold down **POWER** for at least one second to initiate power-up. The projector proceeds through a series of internal diagnostic tests. The complete power-on process takes about 8 seconds.
- 5) If using an IR keypad, ensure it is pointed at the screen or the front of the projector.
- 6) If using an IR keypad, the batteries may need replacement. Remove the batteries from the battery compartment on the back side of the keypad. Install new batteries as described in the section 2.3.
- 7) The keypad may be damaged.
- 8) There may be an internal problem with the projector. Check the LED status at the rear panel. Under normal conditions, the following LEDs are on: 200V, 150V, -24V, +24V, -12V, +12V, +5V and READY. The following LEDs should be off: V INHIBIT, H INHIBIT and ERROR. If this is not the case, contact your dealer for servicing.

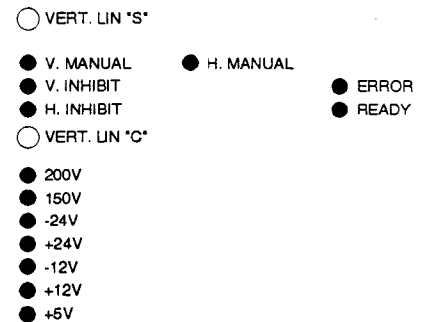

Figure 4-1. Rear Panel LEDs

- Symptom:** The projector's green READY LED is lit yet no picture is displayed.
- Cause/Remedy:**
- 1) Contrast or brightness may be set too low. Press **[*]** to display the configuration screen. If there is no display, press **[#]** then increase contrast and brightness to obtain a display. If a crosshatch is displayed, press **[#]** to remove it. Adjust contrast and brightness to their proper settings.
 - 2) The room lighting may be too bright. Lower the intensity of the room lighting. Reduce light reflections as much as possible.
 - 3) The projector may be too far from the screen. Move the projector closer to the screen. The maximum projector-to-screen distance is 31 feet.
 - 4) Were the lens covers accidentally left on? Remove the lens covers.
 - 5) The projector is badly out of optical focus. Contact your dealer or an authorized service technician for assistance.
- Symptom:** The projector does not respond to the **[STBY]** key.
- Cause/Remedy:**
- 1) You may not be holding down the key long enough to initiate the action. Like **[POWER]**, **[STBY]** must be pressed down for at least one second.
- Symptom:** The projector does not respond to the remote keypad.
- Cause/Remedy:**
- 1) The protocol type (1 or 2) of the remote keypad may not match the projector's protocol setting. Using the built-in keypad, press **[*]** to display the first projector status screen. The projector's protocol setting is shown. If it does not match the keypad protocol, change the protocol setting. (See section 3.7, *Utility Features*).
 - 2) The IR keypad may be too far away from the projector or screen. Use the IR keypad closer to the projector or screen. Also ensure the keypad is pointed directly at the screen or the front of the projector.
 - 3) The viewing path between the IR keypad and the projector (or screen or switcher) may be restricted. Ensure there is a clear line-of-sight between the keypad and the projector (or screen or switcher).
 - 4) The batteries in the IR keypad may be weak. Replace the batteries in the keypad. See section 2.3 for battery installation instructions.
 - 5) There may be unusual lighting conditions in the room which effect IR keypad operation. Determine if such conditions exist and correct.
- Symptom:** The display is jittery or unstable.
- Cause/Remedy:**
- 1) The horizontal or vertical scan frequency of the input signal may be out of range. Check the specifications in Section 5 for scan frequency ranges.
 - 2) Synchronization signals from the source may be inadequate. Correct the source problem.
 - 3) The input signal may not be compatible with the input module to which it is connected. Install the correct input module.
- Symptom:** The upper portion of the display is waving, tearing, or jittering.
- Cause/Remedy:**
- 1) This sometimes occurs when the source is a VCR or video signal. Change the sync mode by pressing **[F SYNC]**.

- Symptom:** A portion of the display is cut off.
- Cause/Remedy:**
- 1) A top or bottom blanking adjustment may be required. Use the Vblank function (**V BLANK**) to adjust the amount of blanking at the top and/or bottom of the display.
 - 2) Use the Move function (**MOVE**) to adjust the horizontal and vertical position of the image.
 - 3) The retrace time of the projector may be longer than the horizontal blanking time of the signal.
- Symptom:** Transitions between colors are fuzzy.
- Cause/Remedy:**
- 1) Convergence may require adjustment. Perform a convergence alignment on the selected source.
 - 2) The projector may not be optically aligned for the installation. Has the throw distance changed significantly since the last optical alignment? If so, have the projector re-aligned by a service technician.
- Symptom:** The display is very faint.
- Cause/Remedy:**
- 1) Contrast or brightness may be set too low.
 - 2) The projection room may be too bright. Lower the intensity of projection room lighting.
 - 3) The projection room walls and ceilings may be too reflective. Reflective ceilings, walls, and floors should be kept to a minimum. The best projection rooms are dark with matte finishing.
 - 4) The projector may be too far from the screen.
 - 5) The location of the audience with respect to the screen may not be adequate. Make sure the audience is within the viewing angle set by the projector and screen position, and the screen type. (See section 2.2).
 - 6) The source may be double terminated. Ensure the source is terminated (75Ω) only once.
- Symptom:** The display repeatedly "flips" on the screen.
- Cause/Remedy:**
- 1) The vertical synchronization frequency of the projector does not match that of the signal. Use the Vertical Hold function (**V HOLD**) to set the vertical synchronization frequency. Try Auto Locking mode first. If unsuccessful, switch to Manual Locking mode to manually set the vertical synchronization frequency. For more information about the Vertical Hold function, refer to section 3.5, *Display Adjustments*.
- Symptom:** The display repeatedly moves across the screen.
- Cause/Remedy:**
- 1) The horizontal synchronization frequency of the projector does not match that of the signal. Use the Horizontal Hold function (**H HOLD**) is used to set the horizontal synchronization frequency. Try Auto Locking mode first. If unsuccessful, switch to Manual Locking mode to manually set the horizontal synchronization frequency. For more information about the Horizontal Hold function, refer to section 3.5, *Display Adjustments*.

Symptom: The display is reversed or upside down.

Cause/Remedy: 1) The projector scan configuration is not set correctly for the installation type. Have an authorized service technician change the scan configuration.

Symptom: The display is not sharp or "clean".

Cause/Remedy: 1) Display adjustment may be required. Adjust the brightness, contrast, focus, and detail settings.
2) Is a BNC T connector being used? Use a distribution amplifier to boost signal levels.
3) Is the input signal properly terminated?
4) The screen size may be too large. As screen size increases, magnification increases which reduces brightness. This then reduces the contrast ratio which affects legibility. Sharp defined edges become soft and fuzzy.
5) The source input signal may be of low quality.

Symptom: Display quality seems to drift (from good to bad, bad to good, etc.).

Cause/Remedy: 1) The operating temperature of the projector may not be constant. Is the projector close to heating and/or air conditioning vents? The ambient temperature after warm-up should be kept constant below 35 °C (95 °F). Make sure none of the projector ventilation slots are obstructed.
2) The source input signal may be of low quality.
3) The horizontal or vertical frequency of the input may have changed. Set ASR to on; the projector will then try to use display parameter settings which are best matched for the source.

Symptom: Colors on the display are not accurate (when using a video decoder).

Cause/Remedy: 1) Color and tint settings may require adjustment.
2) Color temperature adjustment may be required. Call your dealer or an authorized service technician.
3) A poor or improper screen surface is being used.

Symptom: The display is not rectangular in shape.

Cause/Remedy: 1) The geometry settings may not be set correctly. Refer to the Geometry Functions entry in section 3.5, *Display Adjustments*.

Symptom: The display is "noisy".

Cause/Remedy: 1) The input may not be terminated. Make sure the input is terminated (75Ω). If it is the last connection in a passive loop-through chain, it should be terminated at the projector (only).
2) The signal cables carrying the input signal may be of poor quality or are not of the correct impedance type. Use only good quality signal cables. Electrohome cables are recommended.
3) The distance between the input source device and the projector may be too great. If the distance between the input source device and the projector is greater than 25 feet, signal amplification/conditioning may be required.
4) There may be interference from other equipment. Keep the projector away from devices which radiate electromagnetic energy such as motors

and transformers. Common sources of these are slide projectors, speakers, power amplifiers, elevators, etc. Keep 35 mm slide projectors at least 2 feet away from the projector.

- 5) The input signal may be of poor quality.
- 6) If the source is a VCR or off-air broadcast, detail may be set too high.

Symptom: Modified display settings are not being saved in the current setup memory.

- Cause/Remedy:**
- 1) Is the current setup memory locked? Press **[SOURCE]** to display the Source Message. If a  is displayed, unlock the setup (while the Source Message is displayed) by pressing **[KEY]**.
 - 2) Is ASR on? If it is, determine if an ASR occurred by pressing **[SOURCE]** to display the Source Message. If an ASR occurred, the current display settings are only temporary. To save the settings in the current setup memory, perform a forced ASR (**[SOURCE]** then **[▶]** for one second).

Symptom: The display is OK when displaying the crosshatch test pattern (**[#]**) or status screen (**[*]**) but when trying to display a source, nothing is visible.

- Cause/Remedy:**
- 1) You may not be selecting the source correctly. Refer to section 3.3, *Source Selection*, for source selection instructions.
 - 2) The source may not be connected properly. Verify that the input source is active and check the cables between the source and the projector.

Symptom: The display is poorly converged at the top, bottom, or side edges.

- Cause/Remedy:**
- 1) The image may be too close to the raster edge. Use Horizontal and Vertical Move to center the image within the raster.

ACON Errors ►



If the projector includes the optional ACON feature, and an error occurs during automatic convergence or Learn Screen, note the error number displayed on the screen. Refer to Table 3.1 in section 3.6, *Convergence Registration* for error descriptions. Proceed through the following checklist.

- Is the ambient lighting appropriate for projection? A number of problems could result during automatic convergence and/or Learn Screen if the ambient lighting is too bright. Dimmed incandescent lighting is preferred over fluorescent lighting.
- Is the view path of the Locator Assembly completely unobstructed? The view path between the photosensor lens of the Locator Assembly and the entire screen must be completely unobstructed for proper ACON operation.
- Has a Learn Screen been performed since the last projector configuration change? Learn Screen must be performed if:
 - The projector-to-screen distance has changed since the last time Learn Screen was performed.
 - The ACON Locator Assembly mounting position has changed since the last time Learn Screen was performed.
 - The screen type has changed.

If the problem cannot be resolved, call your dealer for assistance or servicing.

Specifications

5.1 Specifications *ECP 3500 Plus Series*

Note: Due to constant research, specifications are subject to change without notice.

- Models** ➤
 - ECP 3500 Plus - Model #38-B09972-97
 - ECP 3501 Plus - Model #38-B09972-AC (includes ACON)
- Optics** ➤
 - High definition F1.0 hybrid lens
 - 10 line pairs per mm
 - 7" high resolution electrostatic focus CRTs
- Resolution** ➤
 - 1280 x 1024 pixels or 1020 TV lines
- Brightness** ➤
 - Usable brightness per industry standard 150 ANSI lumens
- Display** ➤
 - Electronic geometry circuits separately correct top, bottom and sides for flat, curved or rear screens from 5 to 25 feet diagonal
 - Keystone circuitry to correct pictures for angles up to $\pm 15^\circ$ vertically from screen axis
 - ACON automatic convergence on the *ECP 3501 Plus* aligns red, green, and blue for a sharp image in less than three minutes
 - Selectable image blanking time for source to source switching (0s to 5s)
- Signals** ➤
 - Input Level: 0.5 to 1.5 volts p-p, $75\Omega \pm 1\%$ terminated
 - Automatic sync mode selection between sync-on-green, H & V sync, and composite sync in any polarity combination
- ASR** ➤
 - The projector will automatically update all parameters, including convergence, contrast, brightness, keystone, move, etc., when a new source is detected. The new setup is taken from matching memories, or interpolated from preset zone memories.
- Frequency Response** ➤
 - Accommodates 7 nanosecond pixels and digital clock rates over 140 MHz
- DC Restoration** ➤
 - Keyed clamp

- Geometry Distortion** ►
- Horizontal: <2.0%
 - Vertical: <2.0%
- Deflection Circuits** ►
- Vertical Deflection**
- Frequency Range: 45 Hz to 120 Hz autolock
 - Size: automatically regulated over frequency range and adjustable from 20% underscan to 10% overscan
 - Retrace Time: less than 300 microseconds
- Horizontal Deflection**
- Frequency Range: 15 kHz to 72 kHz autolock
 - Size: automatically regulated over frequency range and adjustable from 10% underscan to 10% overscan
 - Retrace Time: 2.5 microseconds
- High Voltage** ►
- 34 KV regulated to better than $\pm 1\%$
- Power Requirements** ►
- 90 VAC to 264 VAC
 - Line Frequency: 50 to 60 Hz nominal
 - Power: 450 watts maximum
- Inputs** ►
- Provided with an RGB Sync 2 Input module which allows connection of two RGB sources.
 - Built-in RS-232 for networking and computer/controller control
 - Many optional input modules available
- Optional Source Expansion** ►
- The Electrohome IR Remove Video/Data Switcher allows use of 6 additional input modules. Up to four switchers can be connected via multi-switcher interface modules for up to 48 inputs.
- Control Features** ►
- Menu driven interface with on-screen help
 - Built-in set up tutorials
 - Auto power up after power interruption
 - Built-in test pattern
- Servicing** ►
- Modular design provides ease of servicing
- Environment** ►
- Maximum Operating Range**
- Temperature: 0 to 35°C
 - Humidity: 0 to 90% non-condensing
 - Altitude: 0 to 3000m (0-10,000 ft.)
- Storage**
- Temperature: -30°C to +65°C
- Heat Dissipation**
- 1700 BTU/Hr (approximate)
- Mounting** ►
- The *ECP 3500/3501 Plus* can be ceiling mounted on its optional ceiling mount or placed on a castered cart for portable applications.

- Weight** ►
- ECP 3500 Plus: 105 lbs / 47.6 kg (127 lbs / 57.6 kg shipping weight)
 - ECP 3501 Plus: 109 lbs / 49.5 kg (131 lbs / 59.4 kg shipping weight)

- Accessories Included** ►
- IR Remote Control Keypad
 - Built-in, Full Function Keypad
 - Tool Kit
 - User's Manual
 - RGB Sync 2 Input Module

- Regulatory Approvals** ►
- FCC Class A, D.H.H.S. 21 CFR, HWC
 - CSA C22.2.950/NRTL (UL)
 - EN60950, EN50081-1, and EN50082-2

- Warranty** ►
- One year parts and labour (see back inside cover)

Physical ►

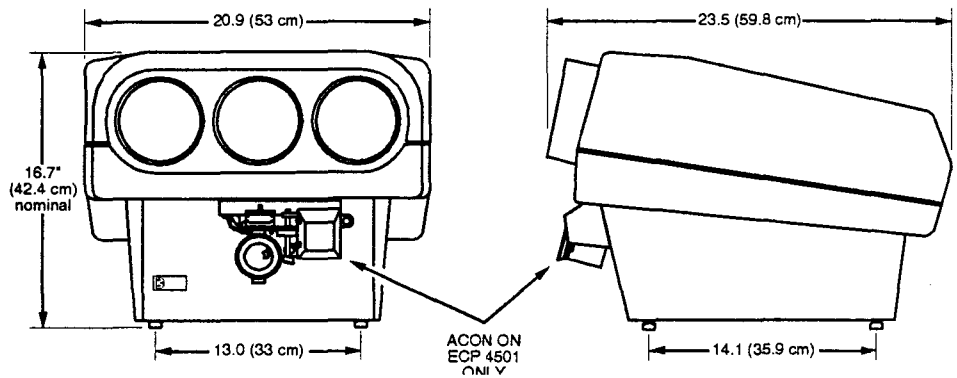

Appendix A

Glossary

This appendix defines many of the terms used in this manual as they apply to the *ECP* projection system.

- ACON (Automatic Convergence)*** ➤ ACON is an optional automatic convergence feature available for *ECP 3500* and *ECP 4500* series projectors. With ACON installed, convergence of the red, green and blue images is performed accurately and automatically with minimal user intervention.
- ASR (Automatic Source Recall)*** ➤ A process whereby the display setup parameters are chosen from memory according to the input signal parameters (horizontal and vertical frequencies). For more information about ASR, refer to the ASR entry in section 3.7, *Utility Features*.
- Active Line Time*** ➤ The time, inside one horizontal scan line, during which video is generated.
- Ambient Light Rejection*** ➤ The ability of a screen to reflect ambient light in a direction away from the "line of best viewing". Curved screens usually have good ambient light rejection. Flat screens usually have less ambient light rejection.
- Analog Video*** ➤ The video output of most computers and video tape machines. Analog video can generate a large number of color hues and levels.
- Aspect Ratio*** ➤ The ratio of the width of an image to its height. Common aspect ratios are 4:3, 5:4, and 16:9.
- Automatic Convergence*** ➤ The automatic alignment of the projected red, green and blue images on the projection screen.
- Autolock*** ➤ The ability of the projector to automatically synchronize to the horizontal and vertical scan frequencies of an input signal.
- Bandwidth*** ➤ The frequency range of the projector's video amplifier. Higher bandwidth figures imply better visibility of fine details in projected images.
- Blanking Time*** ➤ Horizontal Blanking Time is the time inside one scan line during which video is not generated. Vertical Blanking Time is the time inside one frame during which video is not generated.
- Bow*** ➤ The convex or concave curve of the horizontal scan lines in the center of the image.

- Brightness** ➤ Brightness in projection terminology usually describes the amount of light emitted from a surface such as a screen. Brightness is measured in lumens, foot-lamberts, foot-candles, or lux.
- Candela or Candle** ➤ The intensity of light is measured in candelas.
- Channel** ➤ A memory for storing user-assigned source input information such as switcher#, slot#, input# and Recall memory#. The projector has 48 channels, each with its own 2-digit channel number. When channels are properly set, sources and setup parameters can be selected by channel number.
- Channel List** ➤ A list of up to 48 channels (explained above) which may be created, edited, or deleted by the user. The Channel List feature provides an alternative, and sometimes easier, way to select sources and their setups.
- Color Shift** ➤ The change in the tint of a white field across an image.
- Color Temperature** ➤ This term refers to the coloration (reddish, white, bluish, etc.) of a white image. The Kelvin (K) temperature scale is used to measure color temperature.
- Composite Video** ➤ This term refers to the output of video tape players, video disc players, and some computers. Synchronization, luminance, and color signals are combined on one output cable.
- Contrast (ratio)** ➤ The ratio of brightness of the brightest possible area to the darkest possible area of an image.
- Convergence** ➤ The alignment of the projected red, green and blue images on the projection screen.
- Current Setup Memory** ➤ The setup memory (Source, Recall, or Zone) which is currently being used to display a given source's image.
- Curved Screen** ➤ A projection screen which is curved to improve screen gain. Curved screens usually have screen gains which are greater than 1 but viewing angles much less than 180°.
- Diffused Screen** ➤ A type of rear-projection screen which spreads the light striking it. Screen gain is less than 1 but audience viewing angles are increased.
- Display Setting** ➤ The level of a display adjustment. Some display adjustments are: Contrast, Brightness, Bow, Keystone and Focus.
- Flicker** ➤ A rapid variation in brightness created when the frame rate is too slow. (See also Interlace.)

- Foot-candle** ► The intensity of visible light per square foot.
1 foot-candle = 1 lumen/square foot = 10.76 lux
- Foot-lambert** ► The luminance (brightness) which results from one foot-candle of illumination falling on a perfectly diffuse surface.
- Frame Rate** ► The frequency at which complete images are generated. For non-interlaced signals, the frame rate is identical to the vertical frequency. For interlaced signals, the frame rate is one half of vertical frequency.
- Frequency Stamp** ► A user function which stores the scan frequencies of the current input signal into the active setup memory. A memory must be frequency stamped to be used by the ASR feature.
- Gain or Screen Gain** ► The ability of a screen to direct incident light to an audience. A flat matte white wall has a gain of approximately 1. Screens with gain less than 1 attenuate incident light; screens with gain more than 1 direct more incident light to the audience but have a narrow viewing angle. For example: An image reflecting off a 10 gain screen appears 10 times brighter than it would if reflected off a matte white wall. Curved screens usually have higher gain than flat screens.
- Geometry** ► The shape of a projected image. Ideally, the image should be perfectly rectangular with straight edges.
- Help Page** ► A display of help information on the projection screen.
- Horizontal Frequency** ► Also called horizontal scan rate or line rate, this is the frequency at which scan lines are generated. Horizontal frequencies vary amongst sources.
- Hot Spot** ► A circular area of a screen where the image appears brighter than elsewhere on the screen. The hot spot always appears located along the line of sight and "moves" with the line of sight. High gain screens and rear screens designed for slide or movie projection usually have a hot spot.
- Input Module** ► A device that accepts an input signal for display by the projector.
- Interface** ► See Input Module.
- Interlace** ► A method inherent to video and some computer graphics modes used to double vertical resolution without increasing horizontal line rate. Two "fields" are displayed sequentially to form a "frame" such that the scan lines in one field appear between the scan lines of the other field. If the resulting frame rate is too low, the image may flicker depending on the image content.

- Keypad** ➤ A device which allows the user to control projector settings and operation. There are four different keypads which may be used with the projector: the Built-in Keypad, the IR Remote Keypad, the Wired Remote Keypad, and the Presenter's Keypad. For more information about these keypads, refer to the keypads entry in section 3.2, *Projector Basics*.
- Keystone** ➤ A distortion of the image which occurs when the top and bottom borders of the image are not equal in length. Side borders slant in or out, producing a keystone shaped image.
- Learn Screen** ➤ An ACON function which stores screen position data in memory for future reference. Learn Screen is usually performed only once per projector installation. If the ACON Locator Assembly or screen is moved, the Learn Screen function must be repeated. *Note: ACON is an optional projector feature.*
- Linearity** ➤ The degree to which the horizontal and vertical sizes of characters and/or shapes change over the entire screen.
- Line of Best Viewing** ➤ When light from a projector is incident on a screen, the light reflects from the screen such that the angle of reflection equals the angle of incidence. The Line of Best Viewing is along the line of reflection.
- Locator Assembly** ➤ The Locator Assembly, situated on the front of projectors which include the ACON automatic convergence feature, is the "eye" of the ACON system. It includes a photosensor/lens component which mechanically scans the projected display at each convergence point while sensing relative positions of each projected color.
- Locked Setup Memory** ➤ A setup memory may be locked to protect its display settings from being accidentally modified and saved, thus losing the previous settings. 
- Loopthrough (Loopthru)** ➤ A method of feeding a series of high impedance inputs from a single video source with a coaxial transmission line in such a manner that the line is terminated with its characteristic impedance at the last input on the line.
- Lumen** ➤ The amount of visible light emitted by a light source is measured in lumens.
- Lux** ➤ The amount of visible light per square meter incident on a surface.
- 1 lux = 1 lumen/square meter = 0.093 foot-candles*
- Menu** ➤ A list of options which are displayed on the screen for selection by the user.
- Multi-Standard Decoder** ➤ A device that converts NTSC, PAL, SECAM, or S-VHS video to RGB video and composite sync.

- NTSC Video** ➤ A video output format of some video tape and disk players. There are two types of NTSC (National Television Standards Committee) video: NTSC 3.58 and NTSC 4.43. NTSC 3.58 is used primarily in North America and Japan. NTSC 4.43 is less commonly used. NTSC is a 60 Hz standard with 525 lines total (482 active).
- Optical Screen** ➤ A type of rear-projection screen which re-directs light through the screen to increase image brightness in front of the screen. Screen gain is usually greater than 1 but audience viewing angles are reduced.
- PAL Video** ➤ A video output format of some video tape and disk players (used primarily in Europe, China and some South American and African countries). PAL (Phase Alternating Line) is a 50 Hz standard with 625 lines total (576 active).
- Pincushion** ➤ A distortion of the image which occurs when the borders are concave or convex.
- Pixel (Picture Element)** ➤ The smallest discernable element of a computer generated image.
- Presentation Level** ➤ The projector is at presentation level when an image is (or may be) displayed and no control, error, or help messages are displayed. For example, if a help page is displayed, the projector is not at presentation level.
- Projector-to-Screen Distance** ➤ Also called "Throw Distance", the distance between the front of the projector's green lens and the screen.
- Protocol** ➤ The type of code format utilized by IR keypad(s). The standard code is Protocol 1. By using two different protocols, two projectors may be used side by side while being controlled independently by separate remote IR keypads.
- Rear Screen** ➤ A translucent panel for screen projection. Incident light travels through the incident surface of a rear screen and forms an image on the other surface.
- Recall Memory** ➤ A setup memory which is not associated with any particular input.
- Resolution of the CRT** ➤ The maximum number of lines that can be distinguished on the face of a CRT.
- Resolution of the Lens** ➤ The maximum number of alternate white and black horizontal lines that can be distinguished on a screen when a photographic target is placed between the lens and a light source, and illuminated by that light source.
- Resolution of the Projector** ➤ The smaller of CRT and Lens resolutions.
- Retrace Time** ➤ The minimum time required for the projector to return the scanning spot from one edge of a CRT to the other after scanning a complete line of video.

- Rise Time** ➤ The time required by the video amplifier of the projector to increase its output from 10% to 90% of the maximum value.
- RGB Video** ➤ The video output of most computers. It can be analog or digital. Analog RGB video has 3, 4, or 5 wires; one for red, one for green, one for blue, and none, one or two wires for sync. For three wire RGB, the green wire usually also provides sync. (See also TTL Video).
- Scan Frequency** ➤ The horizontal or vertical frequency at which images are generated.
- Scan Line** ➤ One scan line is one horizontal line on the display.
- SECAM** ➤ A video output format of some video tape and disk players (used primarily in France). SECAM (Sequential Couleur á Mémoire) signals are similar in resolution and frequency to PAL signals. The primary difference between the two standards is in the way color information is encoded.
- Setup Memory** ➤ A projector memory which stores user-adjustable display settings. There are three types of setup memories: *Source*, *Recall* and *Zone*. All memory types store the same parameters. The main difference between the three memory types is that Source memories store display settings for a particular physical source input (i.e., slot 1, input 1), while Recall and Zone memories can be used with any input.
- Slidebar** ➤ A slidebar is a graphical display of an adjustment setting. The setting is displayed on a scale of 0 to 10.
- Source** ➤ A device, such as a computer or VCR, which may be connected to the projector for display.
- Source Memory** ➤ A setup memory which is associated with a particular source input. For example, the projector includes a setup memory to store the display parameter settings for the source connected to slot 1, input 1.
- Spot Size** ➤ The diameter of a single dot that can be generated on the face of a CRT.
- Sync** ➤ This term refers to the part of the video signal that is used to stabilize the picture. For RGB sources, sync is usually provided in one of three forms:
- 1) "Composite sync" when the horizontal and vertical components are together on one cable.
 - 2) "Sync-on-green" when the sync is part of the green video signal.
 - 3) "Separate sync" or "H.SYNC and V.SYNC" when the horizontal and vertical components of the sync are on two separate cables.
- Sync Width** ➤ The duration of each sync pulse generated by a computer. The sync width is part of the blanking time.
- TTL Video** ➤ A type of RGB video. It can generate a specific limited number of colors (8, 16 or 64).

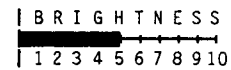













Figure A-1.
Slidebar

- Terminated** ➤ A wire connecting a single video source to a display device, such as a projector, must be terminated by a resistance (usually 75Ω for video).
- Throw Distance** ➤ Also called "Projector-to-Screen Distance", the distance between the front of the projector's green lens and the screen.
- Variable Scan** ➤ The ability of a projector to synchronize to inputs with frequencies within a specified range.
- Vertical Frequency** ➤ The frequency at which images are generated. Vertical frequencies vary amongst sources. This term is also called vertical scan rate.
- Video** ➤ The signal that is used by display devices (such as projectors) to generate a picture. This term also refers to the output of video tape/disk players and computers.
- Video Decoder** ➤ A device that converts NTSC, PAL, SECAM or S-VHS video to RGB video.
- Viewing Angle** ➤ Most screens do not reflect equally in all directions. Most of the light is reflected in a conical volume which is centered around the "line of best viewing". Maximum brightness is seen when you are positioned within the viewing cone. The horizontal and vertical viewing angles are the horizontal and vertical angles of the cone.
- White Balance** ➤ White Balance refers to the color temperature of white used by the projector. See also Color Temperature.
- White Field** ➤ A white field is the area of an image that is white only. For example, a full white field is an image that is white everywhere. A 10% white field is a white area (usually rectangular) that occupies 10% of the image; the remaining 90% is black.
- Zone Memory** ➤ A setup memory which is not associated with any particular input. Zone memories are intended to store the display parameter settings of five different sources, each with a different horizontal frequency within the projector's input frequency band. When the ASR feature is on, Zone memory data is sometimes used or interpolated to improve the display of the current source.

Throw Distance Tables

Table B-1. *Throw Distance (inches)*

 screen width	 screen diagonal	 throw distance	 screen width	 screen diagonal	 throw distance	 screen width	 screen diagonal	 throw distance	 screen width	 screen diagonal	 throw distance
48	60.0	81.7	109	136.3	174.1	153	191.3	240.8	197	246.3	307.5
49	61.3	83.2	110	137.5	175.7	154	192.5	242.3	198	247.5	309.0
50	62.5	84.8	111	138.8	177.2	155	193.8	243.8	199	248.8	310.5
51	63.8	86.3	112	140.0	178.7	156	195.0	245.3	200	250.0	312.0
52	65.0	87.8	113	141.3	180.2	157	196.3	246.9	201	251.3	313.5
53	66.3	89.3	114	142.5	181.7	158	197.5	248.4	202	252.5	315.0
54	67.5	90.8	115	143.8	183.2	159	198.8	249.9	203	253.8	316.5
55	68.8	92.3	116	145.0	184.7	160	200.0	251.4	204	255.0	318.1
56	70.0	93.8	117	146.3	186.3	161	201.3	252.9	205	256.3	319.6
57	71.3	95.4	118	147.5	187.8	162	202.5	254.4	206	257.5	321.1
58	72.5	96.9	119	148.8	189.3	163	203.8	255.9	207	258.8	322.6
59	73.8	98.4	120	150.0	190.8	164	205.0	257.5	208	260.0	324.1
60	75.0	99.9	121	151.3	192.3	165	206.3	259.0	209	261.3	325.6
61	76.3	101.4	122	152.5	193.8	166	207.5	260.5	210	262.5	327.2
62	77.5	102.9	123	153.8	195.3	167	208.8	262.0	211	263.8	328.7
63	78.8	104.4	124	155.0	196.9	168	210.0	263.5	212	265.0	330.2
64	80.0	106.0	125	156.3	198.4	169	211.3	265.0	213	266.3	331.7
65	81.3	107.5	126	157.5	199.9	170	212.5	266.6	214	267.5	333.2
66	82.5	109.0	127	158.8	201.4	171	213.8	268.1	215	268.8	334.7
67	83.8	110.5	128	160.0	202.9	172	215.0	269.6	216	270.0	336.2
68	85.0	112.0	129	161.3	204.4	173	216.3	271.1	217	271.3	337.8
69	86.3	113.5	130	162.5	206.0	174	217.5	272.6	218	272.5	339.3
70	87.5	115.1	131	163.8	207.5	175	218.8	274.1	219	273.8	340.8
71	88.8	116.6	132	165.0	209.0	176	220.0	275.6	220	275.0	342.3
72	90.0	118.1	133	166.3	210.5	177	221.3	277.2	221	276.3	343.8
73	91.3	119.6	134	167.5	212.0	178	222.5	278.7	222	277.5	345.3
74	92.5	121.1	135	168.8	213.5	179	223.8	280.2	223	278.8	346.8
75	93.8	122.6	136	170.0	215.0	180	225.0	281.7	224	280.0	348.4
76	95.0	124.1	137	171.3	216.6	181	226.3	283.2	225	281.3	349.9
77	96.3	125.7	138	172.5	218.1	182	227.5	284.7	226	282.5	351.4
78	97.5	127.2	139	173.8	219.6	183	228.8	286.2	227	283.8	352.9
79	98.8	128.7	140	175.0	221.1	184	230.0	287.8	228	285.0	354.4
80	100.0	130.2	141	176.3	222.6	185	231.3	289.3	229	286.3	355.9
81	101.3	131.7	142	177.5	224.1	186	232.5	290.8	230	287.5	357.5
82	102.5	133.2	143	178.8	225.6	187	233.8	292.3	231	288.8	359.0
83	103.8	134.7	144	180.0	227.2	188	235.0	293.8	232	290.0	360.5
84	105.0	136.3	145	181.3	228.7	189	236.3	295.3	233	291.3	362.0
85	106.3	137.8	146	182.5	230.2	190	237.5	296.9	234	292.5	363.5
86	107.5	139.3	147	183.8	231.7	191	238.8	298.4	235	293.8	365.0
87	108.8	140.8	148	185.0	233.2	192	240.0	299.9	236	295.0	366.5
88	110.0	142.3	149	186.3	234.7	193	241.3	301.4	237	296.3	368.1
89	111.3	143.8	150	187.5	236.3	194	242.5	302.9	238	297.5	369.6
90	112.5	145.4	151	188.8	237.8	195	243.8	304.4	239	298.8	371.1
91	113.8	146.9	152	190.0	239.3	196	245.0	305.9	240	300.0	372.6
92	115.0	148.4									
93	116.3	149.9									
94	117.5	151.4									
95	118.8	152.9									
96	120.0	154.4									
97	121.3	156.0									
98	122.5	157.5									
99	123.8	159.0									
100	125.0	160.5									
101	126.3	162.0									
102	127.5	163.5									
103	128.8	165.0									
104	130.0	166.6									
105	131.3	168.1									
106	132.5	169.6									
107	133.8	171.1									
108	135.0	172.6									





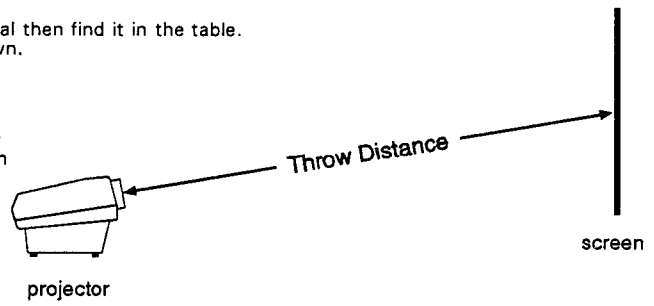







Instructions:
 Measure the screen width or diagonal then find it in the table.
 The required throw distance is shown.

- Notes:**
- All dimension are in inches.
See reverse side for metric table.
 - Throw Distance is measured from the projector's center lens to the center of the screen.
 - Use the Size function to adjust image size.
 - Diagonal sizes shown are based on a 4:3 aspect ratio.



THROW DISTANCE TABLES

Table B-2. Throw Distance (cm)

 screen width	 screen diagonal	 throw distance	 screen width	 screen diagonal	 throw distance	 screen width	 screen diagonal	 throw distance	 screen width	 screen diagonal	 throw distance
122	152.5	208	270	337.5	432	384	480.0	605	498	622.5	777
124	155.0	211	272	340.0	435	386	482.5	608	500	625.0	781
126	157.5	214	274	342.5	438	388	485.0	611	502	627.5	784
128	160.0	217	276	345.0	441	390	487.5	614	504	630.0	787
130	162.5	220	278	347.5	444	392	490.0	617	506	632.5	790
132	165.0	223	280	350.0	447	394	492.5	620	508	635.0	793
134	167.5	226	282	352.5	450	396	495.0	623	510	637.5	796
136	170.0	229	284	355.0	453	398	497.5	626	512	640.0	799
138	172.5	232	286	357.5	456	400	500.0	629	514	642.5	802
140	175.0	235	288	360.0	459	402	502.5	632	516	645.0	805
142	177.5	238	290	362.5	462	404	505.0	635	518	647.5	808
144	180.0	241	292	365.0	465	406	507.5	638	520	650.0	811
146	182.5	244	294	367.5	468	408	510.0	641	522	652.5	814
148	185.0	247	296	370.0	471	410	512.5	644	524	655.0	817
150	187.5	250	298	372.5	474	412	515.0	647	526	657.5	820
152	190.0	253	300	375.0	478	414	517.5	650	528	660.0	823
154	192.5	256	302	377.5	481	416	520.0	653	530	662.5	826
156	195.0	259	304	380.0	484	418	522.5	656	532	665.0	829
158	197.5	262	306	382.5	487	420	525.0	659	534	667.5	832
160	200.0	265	308	385.0	490	422	527.5	662	536	670.0	835
162	202.5	268	310	387.5	493	424	530.0	665	538	672.5	838
164	205.0	271	312	390.0	496	426	532.5	668	540	675.0	841
166	207.5	274	314	392.5	499	428	535.0	671	542	677.5	844
168	210.0	278	316	395.0	502	430	537.5	674	544	680.0	847
170	212.5	281	318	397.5	505	432	540.0	677	546	682.5	850
172	215.0	284	320	400.0	508	434	542.5	681	548	685.0	853
174	217.5	287	322	402.5	511	436	545.0	684	550	687.5	856
176	220.0	290	324	405.0	514	438	547.5	687	552	690.0	859
178	222.5	293	326	407.5	517	440	550.0	690	554	692.5	862
180	225.0	296	328	410.0	520	442	552.5	693	556	695.0	865
182	227.5	299	330	412.5	523	444	555.0	696	558	697.5	868
184	230.0	302	332	415.0	526	446	557.5	699	560	700.0	871
186	232.5	305	334	417.5	529	448	560.0	702	562	702.5	874
188	235.0	308	336	420.0	532	450	562.5	705	564	705.0	877
190	237.5	311	338	422.5	535	452	565.0	708	566	707.5	880
192	240.0	314	340	425.0	538	454	567.5	711	568	710.0	884
194	242.5	317	342	427.5	541	456	570.0	714	570	712.5	887
196	245.0	320	344	430.0	544	458	572.5	717	572	715.0	890
198	247.5	323	346	432.5	547	460	575.0	720	574	717.5	893
200	250.0	326	348	435.0	550	462	577.5	723	576	720.0	896
202	252.5	329	350	437.5	553	464	580.0	726	578	722.5	899
204	255.0	332	352	440.0	556	466	582.5	729	580	725.0	902
206	257.5	335	354	442.5	559	468	585.0	732	582	727.5	905
208	260.0	338	356	445.0	562	470	587.5	735	584	730.0	908
210	262.5	341	358	447.5	565	472	590.0	738	586	732.5	911
212	265.0	344	360	450.0	568	474	592.5	741	588	735.0	914
214	267.5	347	362	452.5	571	476	595.0	744	590	737.5	917
216	270.0	350	364	455.0	574	478	597.5	747	592	740.0	920
218	272.5	353	366	457.5	577	480	600.0	750	594	742.5	923
220	275.0	356	368	460.0	581	482	602.5	753	596	745.0	926
222	277.5	359	370	462.5	584	484	605.0	756	598	747.5	929
224	280.0	362	372	465.0	587	486	607.5	759	600	750.0	932
226	282.5	365	374	467.5	590	488	610.0	762	602	752.5	935
228	285.0	368	376	470.0	593	490	612.5	765	604	755.0	938
230	287.5	371	378	472.5	596	492	615.0	768	606	757.5	941
232	290.0	374	380	475.0	599	494	617.5	771	608	760.0	944
234	292.5	378	382	477.5	602	496	620.0	774	610	762.5	947
236	295.0	381									
238	297.5	384									
240	300.0	387									
242	302.5	390									
244	305.0	393									
246	307.5	396									
248	310.0	399									
250	312.5	402									
252	315.0	405									
254	317.5	408									
256	320.0	411									
258	322.5	414									
260	325.0	417									
262	327.5	420									
264	330.0	423									
266	332.5	426									
268	335.0	429									

Instructions:

Measure the screen width or diagonal then find it in the table.
The required throw distance is shown.

Notes:

1. All dimension are in centimetres.
See reverse side for imperial table.
2. Throw Distance is measured from the projector's center lens to the center of the screen.
3. Use the Size function to adjust image size.
4. Diagonal sizes shown are based on a 4:3 aspect ratio.

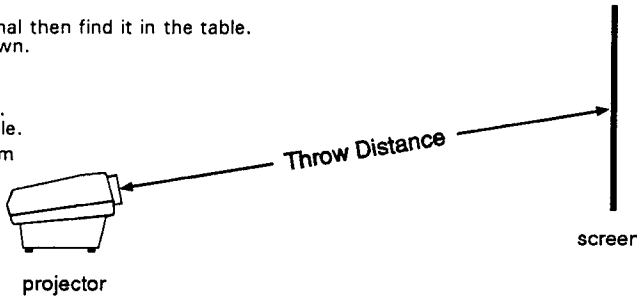

ASR Reference

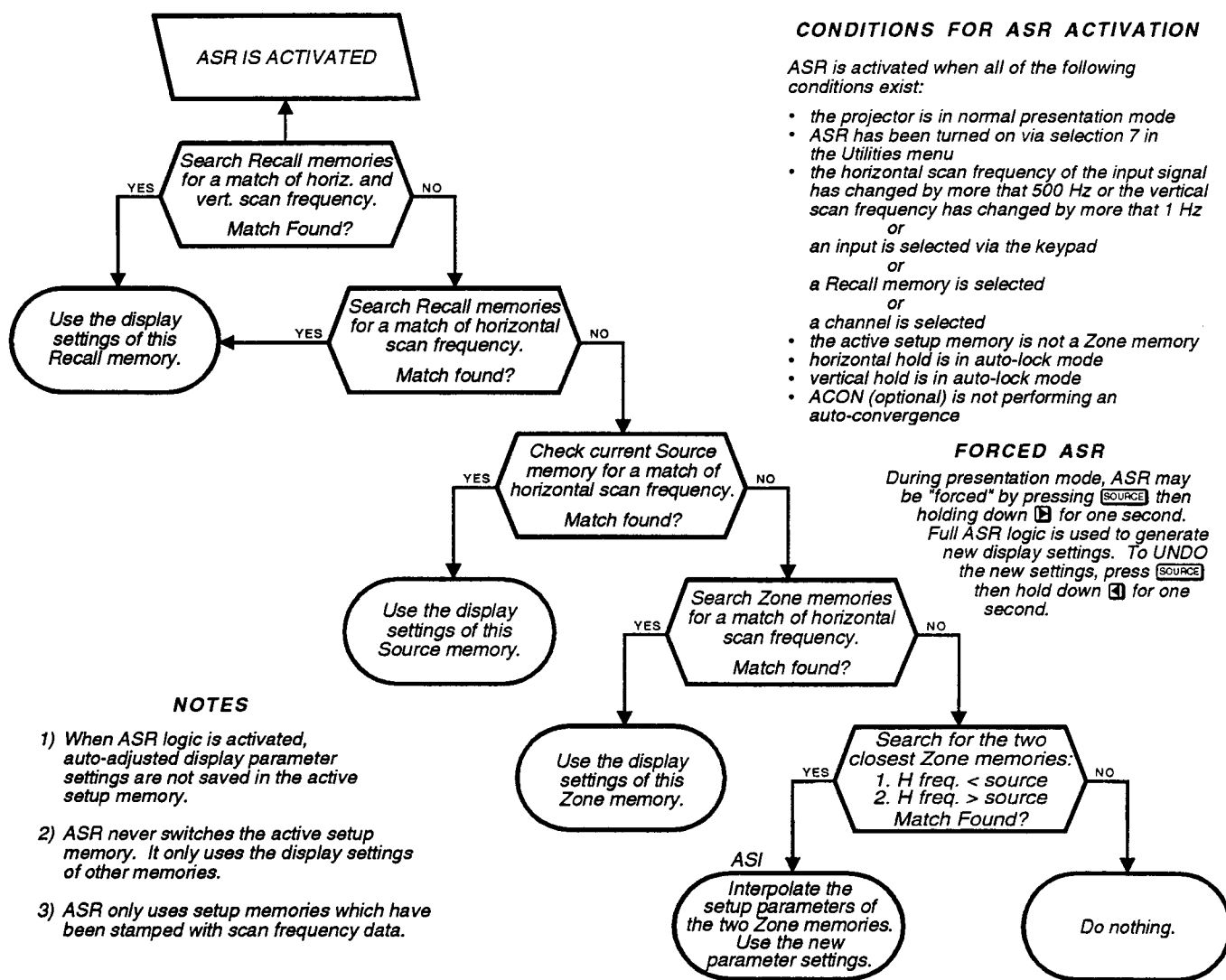

Figure C-1. ASR Logic Diagram

Questions & Answers ►

The following questions and answers may be helpful to better understand how to use ASR.

- Question:* Does ASR automatically switch the active setup memory?
Answer: No. Only the user (via keypad control) can switch setup memories. If ASR uses another setup memory, it only copies its settings for the current display.
- Question:* Can ASR be turned on temporarily?
Answer: Yes. ASR can be temporarily "forced" to automatically adjust the current display settings. Newly created display settings are saved in the active setup memory. To force an ASR, press **[SOURCE]** then hold down **[▶]** for one second.
- Question:* Can ASR change the display parameter settings stored in the active setup memory?
Answer: If ASR was not forced, no. If the ASR is forced, the display settings will be saved in the active setup memory. To UNDO recent changes by a forced ASR, press **[SOURCE]** then hold down the **[◀]** key for one second.
- Question:* What happens if none of the setup memories have been frequency stamped and ASR is on?
Answer: Nothing. If none of the setup memories are frequency stamped, ASR will never locate a setup memory which satisfies the ASR logic conditions.
- Question:* How do I know which setup memory was used by ASR for the current display parameters?
Answer: To know for sure, press **[SOURCE]** to display the source status screen. The status screen always shows the active setup memory and the memory used by ASR. Refer to the ASR entry in section 3.7, *Utility Features*, for example ASR messages.
- Question:* Why does it seem that ASR is not working?
Answer: There could be many reasons:
- 1) ASR was not turned on (via the Utilities menu).
 - 2) H Hold and V Hold are not set to Auto Lock for the current source.
 - 3) The active setup memory is a Zone memory.
 - 4) The source was switched via the Source command versus external switching.
 - 5) None of the Source, Recall or Zone memories have been frequency stamped.
- Question:* Is it okay to leave ASR turned on even if I do not normally switch sources externally?
Answer: If your installation does not require sources to be switched externally, there is no advantage to having ASR turned on. It is then recommended to turn ASR off.

Communication Cables

When linking projectors or connecting the projector to a computer or controller, one or more standard RS-232 serial communication cables are required. Cable details are provided below.

Cable Type: RS-232, 9 Pin Male to 9 Pin Female

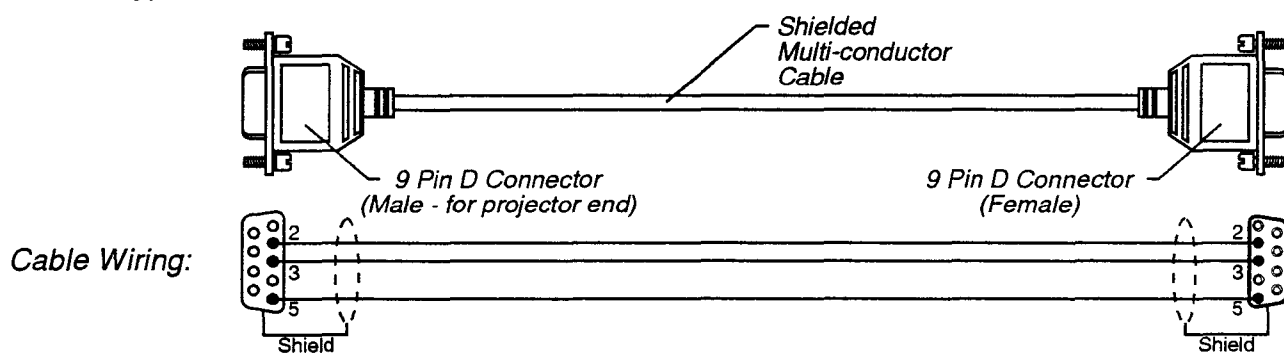

- Application:**
- For connection between projectors.
 - For connection to a computer or controller with a 9 pin "AT" type RS-232 port.

Cable Type: RS-232, 9 Pin Male to 25 Pin Female

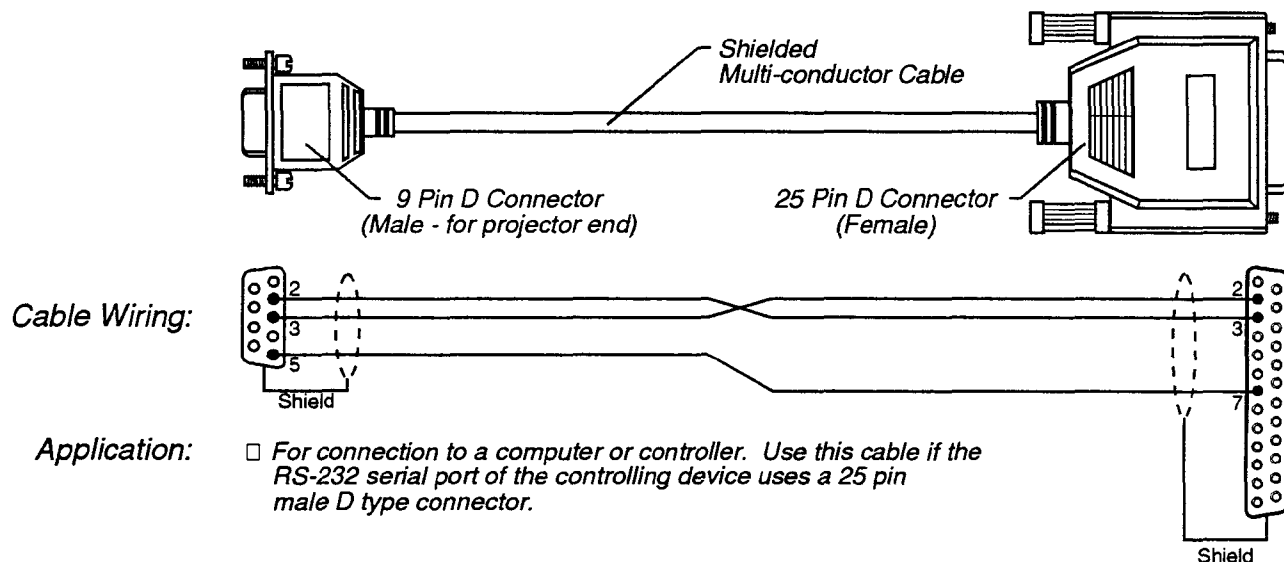

- Application:**
- For connection to a computer or controller. Use this cable if the RS-232 serial port of the controlling device uses a 25 pin male D type connector.

Keypad Reference

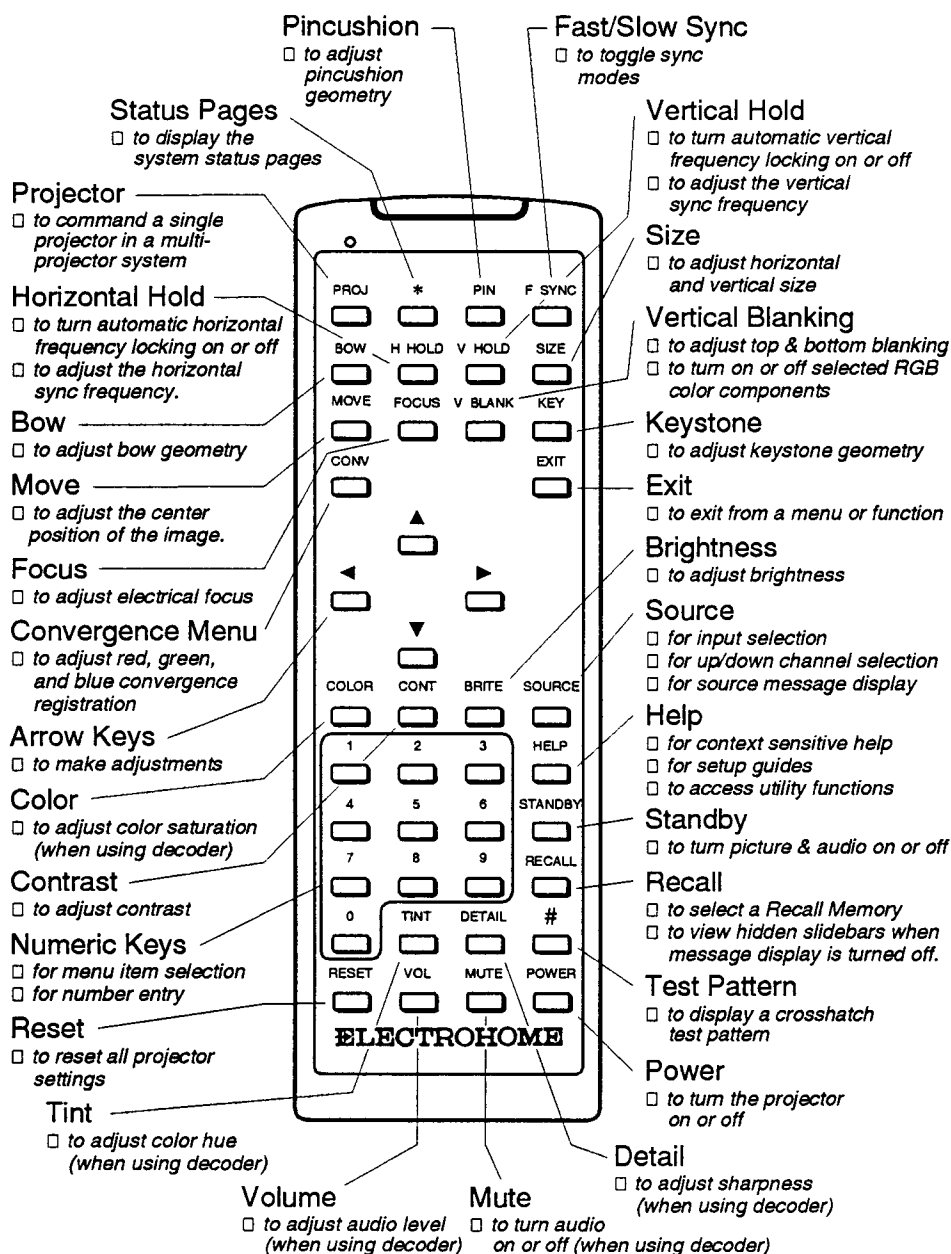

Figure E-1. Full Function Keypad

Projector Default Settings

Table F-1. Projector Default Settings

FUNCTION	SETTING	FUNCTION	SETTING
Setup Memories:		Functions:	
BOW	5	SOURCE	
BRITE	5	· SLOT	1
COLOR	5	· INPUT	1
CONT	3	STBY	OFF
DETAIL	5	PROJ	000
FAST/SLOW SYNC	SLOW		
H HOLD	AUTO	Utility Settings:	
FOCUS	5	Auto Power-On	OFF
KEY	5	Auto Source Recall	OFF
MOVE	NO MOVE	Blanking Time	3
HORZ MOVE	0	Channel List	Null
VERT MOVE	0		(all channels)
HV MOVE H	0	Keypad Protocol	ONE
HV MOVE V	0	Message Display	ON
MUTE	OFF	Mounting Configuration	UPRIGHT ON
PIN	5		FRONT SCREEN
SIZE	5	Projector ID	000
TINT	5		
V BLANK		RS-232 Settings:	
· TOP	10	Baud Rate	9600
· BOTTOM	0	Network Address	000
V HOLD	AUTO	Broadcast Mode	ON
VOL	5		
Convergence (all points)	0		

A

- AC Input Requirements, 2-11
- ACON
 - setup, 2-21
- Aspect Ratio
 - definition, A-1
- ASR
 - described, 3-32
 - examples, 2-18
 - forced, 3-33
 - logic diagram, C-1
 - memory setup, 2-16
 - message, 3-13
 - Q&A, C-1
 - status page, 3-9
 - turning off and on, 3-32
- Audio
 - mute function, 3-8
 - volume function, 3-8
- Auto Power-Up
 - utility, 3-35
- Automatic Convergence, 3-24

B

- Baud Rate
 - modifying the, 2-15
- Blanking Time Utility, 3-35
- Bow Function, 3-20
- Brightness Function, 3-16
- Broadcast Mode, 2-15
- Built-in Keypad
 - described, 3-2

C

- Ceiling Mount, 2-9
- Channel List
 - definition, A-2
 - utility, 3-28
- Channels
 - direction selection of, 3-12
 - up/down selection of, 3-12
- Cleaning, 4-3
- Color, 3-17
- Communication Cables, D-1
- Communications
 - baud rate, 2-15
 - RS-232, 2-13
- Computer Control, 2-14
- Confirmation Screens, 3-5
- Contrast, 3-16

Controller

- use with, 2-14

Convergence

- ACON, 3-24
 - definition, A-2
 - guided, 3-22
 - interpolated, 3-24
 - on image, 3-22
 - random access, 3-23
 - reset, 3-22
 - types of, 3-21
- Copying Projector Setups, 3-31

D

- Default Projector Settings, F-1
- Detail, 3-17
- Detailed Setup Guide, 3-6
- Diffused Screens, 2-10
- Display Adjustments, 3-16
 - convergence, 3-21
 - geometry, 3-20
 - picture, 3-17
 - primary, 3-16

E

- Error Messages
 - ACON, 3-27
- Expandability, 1-2

F

- Fast/Slow Sync, 3-18
- Focus
 - electrical, 3-19
 - Optical, 3-6
- Forced ASR, 3-33
- Frequency Stamping, 3-34
- Full Function Keypad, 3-2

G

- Geometry Functions, 3-20
- Glossary, A-1
- Guided Convergence, 3-22
- Guidelines
 - for projector use, 4-1

H

- Help
 - context help, 3-6
 - guided, 3-6
 - using, 3-6
- Horizontal Hold, 3-18

I

- ID Number
 - setting the, 3-31
- Input Modules
 - optional, 2-12
 - RGB Sync 2 Input, 2-13
- Inputs
 - selection of, 3-10
- Installation, 2-1
 - considerations, 2-2
 - types, 2-2
- Interfaces
 - optional, 2-12
- Interpolated Convergence, 3-24
- IR Remote Keypad, 3-2

K

- Keypad
 - battery installation, 2-8
 - controls, 3-2
 - guide, 3-6
 - illustration, E-1
 - types, 3-1
 - usage, 3-3
- Keypad Protocol Utility, 3-30
- Keystone Function, 3-20

L

- Learn Screen (ACON), 3-26
- Leg Adjustment, 2-9
- Lighting, 2-5
- Linking Projectors, 2-13
- Locator Assembly, A-4
- Locked Setup Memories, 3-15

M

- Memories
 - setup of, 2-16
- Menus, 3-4
- Messages, 3-5
 - source, 3-12
- Mirror
 - the use of, 2-10
- Mounting
 - front screen, 2-8
 - rear screen, 2-10
- Mounting Configuration
 - utility, 3-29
- Multi-projector Functions, 3-36
- Multi-Standard Decoder
 - definition, A-4

Index

Mute, 3-8
Network Address
 described, 2-14
 modifying the, 2-15
Networking Projectors, 2-13

O

Optical Screens, 2-10

P

Picture Functions, 3-17
Pincushion Function, 3-20
Power
 connection of, 2-11
 turning on/off, 3-7
Presentation Level, 3-4
Presenter's Keypad, 3-2
Primary Display Adjustments,
 3-16
Projection Room
 lighting, 2-5
 reflections, 2-5
 ventilation, 2-7
 windows, 2-5
Projector
 construction, 1-2
 control function, 3-36
 default settings, F-1
 description, 1-1
 dimensions, 5-3
 features, 1-1
 installation, 2-1
 ID number, 3-36
 ID number utility, 3-31
 mounting, 2-8
 position, 2-6, 2-7
 usage guidelines, 4-1
 warm up time, 3-7
Projector-to-Screen Distance
 calculating, 2-5
Protocol
 definition, A-5
Purchase Record, 1-2

Q

Quick Setup
 instructions, 2-1
Quick Setup Guide, 3-6

R

Random Access Convergence,
 3-23
Recall Memories, 3-14
 setup of, 2-17
Regulatory Approvals, 5-3
RGB Sync 2 Input Module, 2-13
RS-232
 cables required, D-1
RS-232 Serial Ports, 2-13

S

Screen
 aspect ratio, 2-4
 diffused, 2-10
 distance, 2-4
 gain, A-3
 optical, 2-10
 size, 2-4
 types, 2-3