

BARCO

VISION
1600HDTV

90 00670 - 90 00671

90 00678 - 90 00679

OWNER'S MANUAL

BARCO

BARCO Projection Systems

BARCO **VISION**
1600HDTV

90 00670 - 90 00671

90 00678 - 90 00679

OWNER'S MANUAL

for software release 3.x

Date :
10/02/92

ART. NR. :
59 75904

Due to constant research, the information in this manual is subject to change without notice.

Produced by BARCO NV, 1992
All rights reserved.

Printed in Belgium.

CONTENTS

WARNINGS	5
SAFETY INSTRUCTIONS	5
LOCATION AND FUNCTIONS OF CONTROLS	13
Rear panel terminology	14
Front panel terminology	16
RCU800 Control panel terminology	17
Controlling the projector with the RCU800	19
POWER (MAINS) CONNECTION	21
Power (mains) cord connection	22
Switching on	23
CONNECTIONS	25
Connecting a Composite VIDEO source to port 1	27
Connecting a S-VIDEO source to port 2	28
Connecting a RGB Analog source to port 4/5	29
Connecting a HDTV source to the analog inputs of the projector.	30
Connecting a RCVD 800 to the BARCOVISION 1600	31
PERIPHERAL EQUIPMENT	31
Connecting a computer, e.g. IBM PC (or compatible), Apple Mac or Workstation to the BARCOVISION 1600	31
PROJECTOR CONTROLLING	33
The RCU800	34
Stand alone projector	34
Controlling stand alone projector with the RCU800	35
Controlling chained projectors	39
Chained projectors	39
The RCU800	39
START UP OF THE ADJUSTMENT MODE	41
Entering the adjustment mode	42
Adjustment mode	43
Guided adjustment mode	45
Start up of the guided adjustment mode	46
Overview flow chart 'Guided Adjustment' procedure	47
Selecting Setup Pattern	49
Raster Centering on Green CRT Faceplate	52
Shifting Red and Blue on Green	53
Left-Right (East-West) Adjustments	54
Vertical Centerline Bow Adjustment	54
Vertical Centerline Skew Adjustment	55
Side Keystone Adjustment	56
Side Bow Adjustment	57
Horizontal Size Adjustment	58
Top-Bottom (North-South) Adjustments	59
Horizontal Centerline Skew Adjustment	60
Horizontal Centerline Bow Adjustment	61
Top Keystone Adjustment	62
Top Bow Adjustment	63
Bottom Keystone Adjustment	64
Bottom Bow Adjustment	65
Size-linearity Adjustment	66
Horizontal Size Adjustment	67

Vertical Linearity Adjustment	68
Vertical Size Adjustment	69
Horizontal Phase Adjustment	70
Convergence Adjustment	71
Blanking Adjustment	73
Top blanking adjustment	74
Bottom blanking adjustment	75
Left blanking adjustment	76
Right blanking adjustment	77
Random access adjustment mode	79
Starting up the random access adjustment mode.	80
Overview flow chart 'Random Access Adjustment' mode.	81
Selecting Setup Pattern	83
Internal Cross Hatch Pattern	84
Random access adjustment mode selection menu.	85
Sync Fast/Slow Adjustment	85
Enhanced Blue On/Off Adjustment	86
Color Select	86
Color balance	87
White balance	88
Black balance	89
Geometry Adjustments	90
Horizontal Phase Adjustment	91
Raster Shift Adjustment	92
Left-Right (east-west) Adjustments	93
Vertical Centerline Bow Adjustment	94
Vertical Centerline Skew Adjustment	95
Side Keystone Adjustment	96
Side Bow Adjustment	97
Top-Bottom (north-south) Adjustments	98
Horizontal Centerline Bow Adjustment	99
Horizontal Centerline Skew Adjustment	100
Top Keystone Adjustment	101
Top Bow Adjustment	102
Bottom Keystone Adjustment	103
Bottom Bow Adjustment	104
Horizontal Size Adjustment	105
Vertical Linearity Adjustment	106
Vertical Size Adjustment	107
Blanking Adjustments	108
Top Blanking Adjustment	109
Left Blanking Adjustment	111
Right Blanking Adjustment	112
Convergence adjustments	113
Service mode	115
Starting up the service mode.	116
Overview flow chart 'Service' mode.	117
Start up screen.	119
Copy a block	120
Deletion of blocks	121
Deleting block per block	121
Deletion of all blocks	123
Change password	124
Run time	125
Set to midposition	126
Convergence off	126

CONTENTS

MESSAGES, WARNINGS AND FAILURES	127
OPTIONS	133
RCU800U	134
IR Receiver 800	135
Hardwired RCU800 or RCU800U	136
Control 800 software	137
RCVDS 800	137
IRIS 800	137
HDTV / Tri-level sync interface	138
Adapter and communication cables	138
APPENDIX A : BATTERY REPLACEMENT IN THE RCU	139
APPENDIX B : ADJUSTMENT BLOCKS	140
APPENDIX C : SOURCE NUMBERS 90 - 99	141
APPENDIX D : SPECIFICATIONS	142

CONTENTS

WARNINGS

SAFETY INSTRUCTIONS

on safety

on installation

on servicing

on cleaning

on repacking

on illumination

INSTALLATION INSTRUCTIONS

Before operating your projector please read this manual thoroughly, and retain it for future reference.

Installation and preliminary adjustments should be performed by qualified BARCO personnel or BARCO authorized service dealers.

OWNER'S RECORD

The part number and serial number are located at the rear. Record these numbers in the spaces provided below. Refer to them whenever you call upon your BARCO dealer regarding this product.

PART NUMBER: _____

CH. ____

SER. NUMBER: _____

SAFETY INSTRUCTIONS

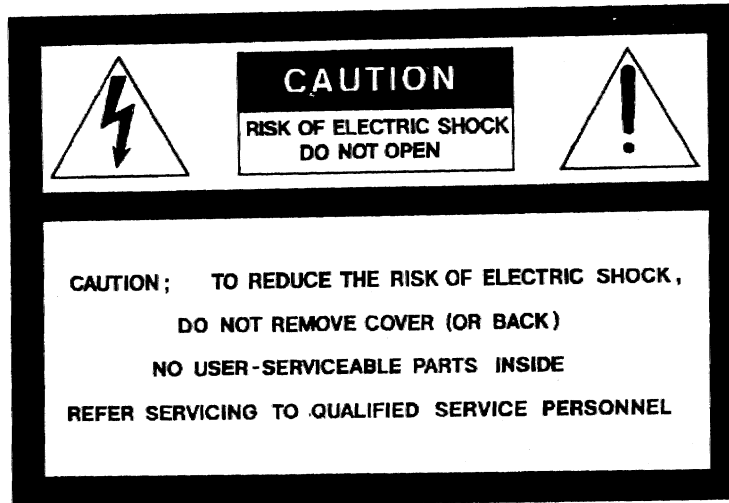

The lightning flash with an arrowhead within a triangle is intended to tell the user that parts inside this product are risk of electrical shock to persons.



The exclamation point within a triangle is intended to tell the user that important operating and/or servicing instructions are included in the technical documentation for this equipment.

WARNING
TO PREVENT FIRE OR ELECTRICAL SHOCK HAZARD, DO NOT EXPOSE THIS PROJECTOR TO RAIN OR MOISTURE

FEDERAL COMMUNICATION COMMISSION (FCC STATEMENT)

This equipment generates, uses, and can radiate radio frequency energy and if not installed and used in accordance with the instruction manual, may cause interference to radio communications. It has been tested and found to comply with the limits for Class A computing device pursuant to Subpart J of Part 15 of FCC Rules, which are designed to provide reasonable protection against such interference when operated in a commercial environment. Operation of this equipment in a residential area is likely to cause interference in which case the user at his own expense will be required to take whatever measures be required to correct the interference.

SAFETY INSTRUCTIONS

* All the safety and operating instructions should be read before using this unit.

* The safety and operating instructions manual should be retained for future reference.

* All warnings on the projector and in the documentation manuals should be adhered to.

* All instructions for operating and use of this equipment must be followed precisely.

ON SAFETY

1. Operating AC power voltage of the projector:

BARCOVISION 1600

Art.No. 90 00670 - 90 00671 (230V AC)

Art.No. 90 00688 - 90 00689 (120V AC)

If you are not sure of the type of AC power available, consult your dealer or local power company.

2. This product is equipped with a 3-wire grounding plug, a plug having a third (grounding) pin. This plug will only fit into a grounding-type power outlet. This is a safety feature. If you are unable to insert the plug into the outlet, contact your electrician to replace your obsolete outlet. Do not defeat the purpose of the grounding-type plug.

WARNING: THIS APPARATUS MUST BE GROUNDED (EARTHED)

WARNING FOR THE CUSTOMERS: THIS APPARATUS MUST BE GROUNDED (EARTHED) via the supplied 3 conductor AC power cable in accordance with the following instructions:
(If the supplied power cable is not the correct one, consult your dealer.)

SAFETY INSTRUCTIONS

A. Mains lead (AC Power cord) with CEE 7 plug:

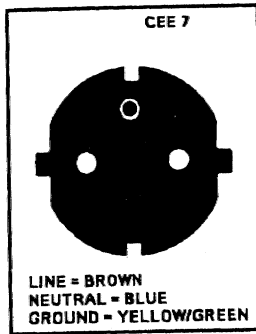

The colors of the mains lead are colored in accordance with the following code:

Green-and-yellow:	Earth (safety earth)
Blue:	Neutral
Brown:	Live

B. Power cord with ANSI 73.11 plug:

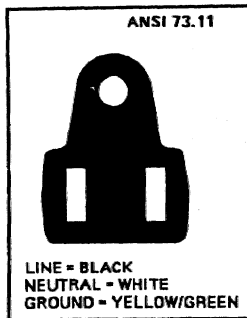

The wires of the power cord are colored in accordance with the following code.

Green/yellow:	ground
White:	neutral
Black:	live

3. Do not allow anything to rest on the power cord. Do not locate this product where persons will walk on the cord.

To disconnect the cord, pull it out by the plug. Never pull the cord itself.

4. If an extension cord is used with this product, make sure that the total of the ampere ratings on the products plugged into the extension cord does not exceed the extension cord ampere rating. Also make sure that the total of all products plugged into the wall outlet does not exceed 15 amperes.

5. Never push objects of any kind into this product

through cabinet slots as they may touch dangerous voltage points or short out parts that could result in a risk of fire or electrical shock.

Never spill liquid of any kind on the product. Should any liquid or solid object fall into the cabinet, unplug the set and have it checked by qualified service personnel before resuming operations.

6. Lightning - For added protection for this video product during a lightning storm, or when it is left unattended and unused for long periods of time, unplug it from the wall outlet. This will prevent damage to the projector due to lightning and AC power-line surges.

SAFETY INSTRUCTIONS

ON INSTALLATION

1. Do not place this projector on an unstable cart, stand, or table. The projector may fall, causing serious damage to it.
2. Do not use this projector near water.
3. Slots and openings in the cabinet and the back or bottom are provided for ventilation; to ensure

reliable operation of the projector and to protect it from overheating, these openings must not be blocked or covered. The openings should never be blocked by placing the product on a bed, sofa, rug, or other similar surface. This product should never be placed near or over a radiator or heat register. This projector should not be placed in a built-in installation or enclosure unless proper ventilation is provided.

ON SERVICING

Do not attempt to service this projector yourself, as opening or removing covers may expose you to dangerous voltage potentials and risk of electric shock!

Refer all servicing to qualified service personnel.

Unplug this product from the wall outlet and refer servicing to qualified service personnel under the following conditions:

- a. When the power cord or plug is damaged or frayed.
- b. If liquid has been spilled into the projector.
- c. If the product has been exposed to rain or water.

d. If the product does not operate normally when the operating instructions are followed.

Adjust only those controls that are covered by the operating instructions since improper adjustment of the other controls may result in damage and will often require extensive work by a qualified technician to restore the product to normal operation;

e. If the product has been dropped or the cabinet has been damaged;

f. If the product exhibits a distinct change in performance, indicating a need for service.

Replacement parts - When replacement parts are required, be sure the service technician has used original BARCO replacement parts or authorized replacement parts which have the same characteristics as the BARCO original part. Unauthorized substitutions may result in degraded performance and reliability, fire, electric shock or other hazards. Unauthorized substitutions may void warranty.

Safety check - Upon completion of any service or repairs to this projector, ask the service technician to perform safety checks to determine that the projector is in proper operating condition.

SAFETY INSTRUCTIONS

ON CLEANING

Unplug this product from the wall outlet before cleaning. Do not use liquid cleaners or aerosol cleaners. Use a damp cloth for cleaning.

- To keep the cabinet looking brand-new, periodically clean it with a soft cloth. Stubborn stains may be removed with a cloth lightly dampened with mild detergent solution. Never use strong solvents, such

as thinner or benzine, or abrasive cleaners, since these will damage the cabinet;

- To ensure the highest optical performance and resolution, the projection lenses are specially treated with an anti-reflective coating, therefore : avoid touching the lens. To remove dust on the lens, use a soft dry cloth. Do not use a damp cloth, detergent solution, or thinner.

ON REPACKING

Save the original shipping carton and packing material; they will come in handy if you ever have

to ship your projector. For maximum protection, repack your set as it was originally packed at the factory.

ON ILLUMINATION

In order to obtain the best quality for the projected image, it is essential that the ambient light which is allowed to fall on the screen be kept to an absolute minimum.

When installing the projector and screen, care must be taken to avoid exposure to ambient light directly on the screen. Avoid adverse illumination on the screen from direct sunlight or florescent lighting fixtures.

The use of controlled ambient lighting, such as incandescent spot light or a dimmer, is recommended for proper room illumination. Where possible, care should also be taken to ensure that the floors and walls of the room in which the projector is to be installed are non-reflecting, dark surfaces. Brighter surfaces will tend to reflect and diffuse the ambient light and hence reduce the contrast of the projected image on the screen.

LOCATION AND FUNCTIONS OF CONTROLS

REAR PANEL TERMINOLOGY

FRONT PANEL TERMINOLOGY

RCU800 TERMINOLOGY

LOCATION AND FUNCTIONS OF CONTROLS

REAR PANEL TERMINOLOGY

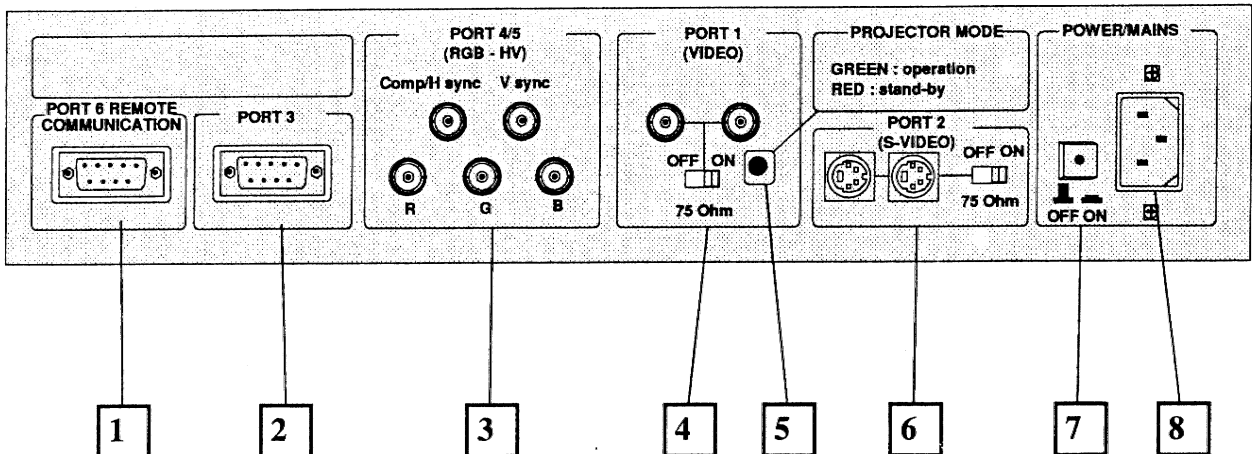

1 **Port 6 : Remote Communication :**

- * allows communication between the RCVDS switcher and the projector.
- * allows connection of a remote IR receiver unit to the projector.

2 **Port 3 : TTL input (9-pins female D-connector):**

TTL input : allows a character generator, microcomputer, etc. having RGB TTL outputs to be connected.

3 **Port 4/5 : RGB-S IN (5x BNC connector):** allows a character generator, microcomputer, video camera, etc. having analog RGB output to be connected.

Line inputs: - color signals RED-GREEN-BLUE
- VERT. sync. signal
- COMPOSITE sync., HOR. sync. signal

4 **Port 1 : VIDEO IN (Composite video, 2x BNC connector):** allows a video tape recorder, video camera, color receiver/monitor, etc. having video line output to be connected.

When no loop-through connection is desired, put the 75 ohm line termination switch in the ON position.

LOCATION AND FUNCTIONS OF CONTROLS

REAR PANEL TERMINOLOGY

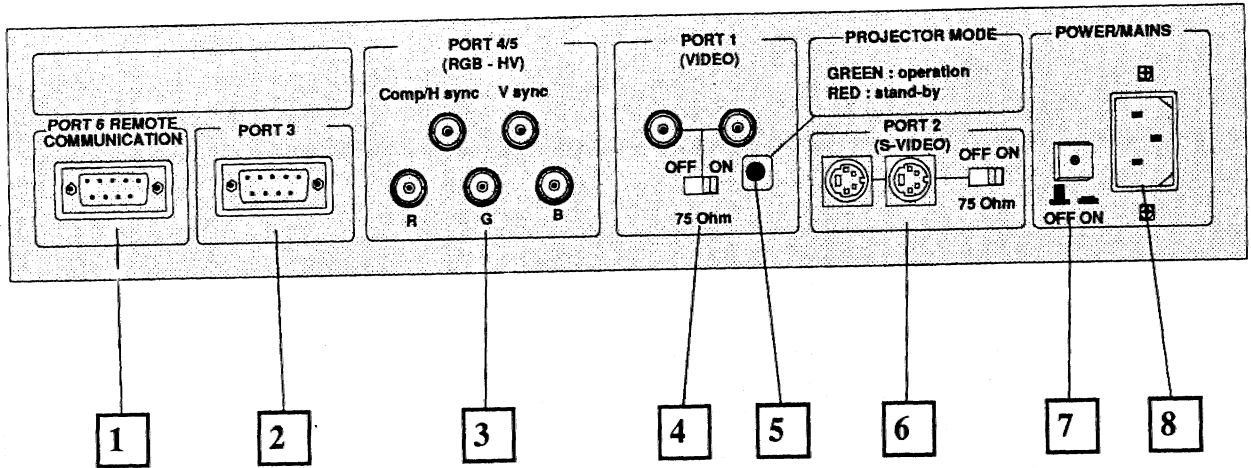

5 PROJECTOR PILOT LAMP: indicates the status of the projector.

- doesn't light up: mains (power) switch is not pressed.
- lights up: mains (power) switch is pressed and the lighting color indicates the projector mode:

GREEN color: OPTIONAL mode of the projector

RED color: STANDBY mode of the projector.

Important: projector mode ("**operational**" or "**standby**") defined during the installation of the projector. (Refer to a qualified technician for change)

6 Port 2 : S-VIDEO IN: Separated Y/C (luma-chroma) signal inputs and outputs for higher quality dubbing and playback of Super VHS signals (4-pin S-VIDEO IN and S-VIDEO OUT).

When no loop-through connection is desired, put the 75 ohm line termination switch in the ON position.

7 POWER (MAINS) SWITCH : press the switch to turn the projector ON.

Depending on the hardware set-up of the projector during installation, the projector switches to '**standby**' or to '**operational mode**' (refer to explanation of pilot lamp [5]).

8 POWER (MAINS) INPUT: Connect the supplied ac power (mains) cord here and to wall the outlet.

LOCATION AND FUNCTIONS OF CONTROLS

FRONT PANEL TERMINOLOGY

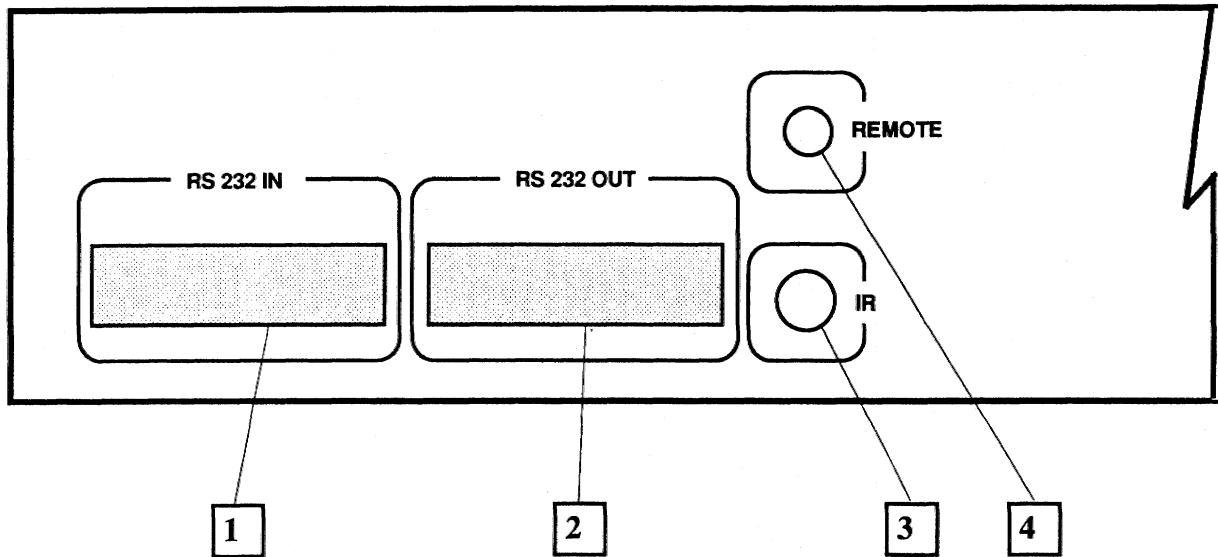

- 1** **RS232 IN** : connection between the BARCOVISION 1600 and a IBM PC (or compatible) or a MAC for remote computer control and data communication.
- 2** **RS232 OUT** : Used to connect to the next projector, RS232IN plug (communication link for PC or MAC to the next projector).
- 3** **IR input** : receiver for control signals transmitted from the RCU800.
- 4** **REMOTE** : remote input for wired remote control by the RCU800.

LOCATION AND FUNCTIONS OF CONTROLS

RCU800 CONTROL PANEL TERMINOLOGY

This remote control allows for each connected input source separately a set-up and an automatic storing of:

- analog controls (Brightness, Sharpness,....)
- picture geometry adjustments
- convergence adjustments

Other functions on the remote control are:

- switching to standby and to operational mode
- switching to "pause" (blanked picture, full power for immediate restarting)
- direct access to all connected sources
- variable adjustment speed : when pushing continuously on the arrow keys or the the picture keys, the adjustment will be executed in a quicker way.

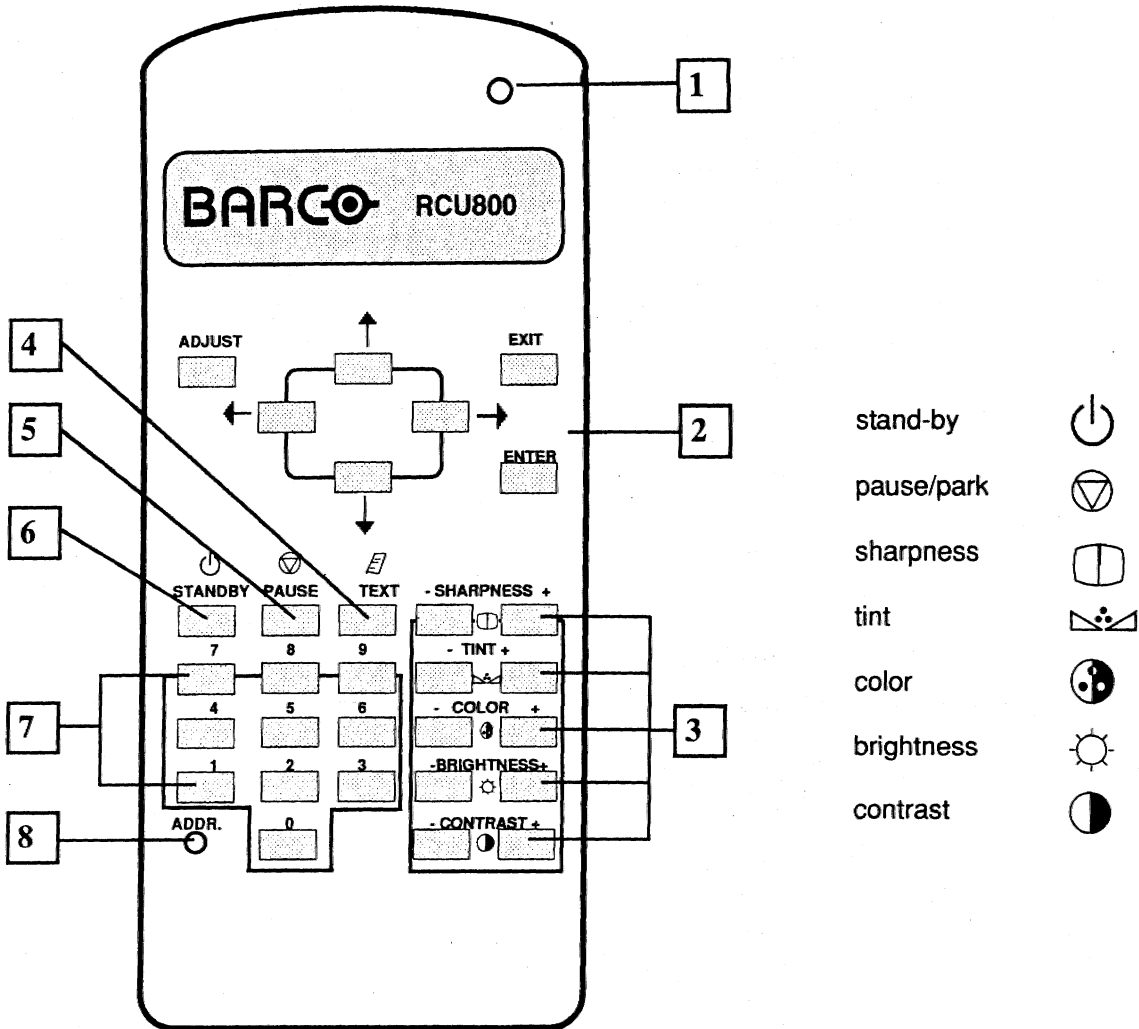

1 RC operating indicator: lights when a button on the remote control is pressed. (This is a visual indicator to check the operation of the Remote control).

2 ADJUSTMENT-SETTINGS KEYS: these keys are used for picture geometry and convergence adjustments.

LOCATION AND FUNCTIONS OF CONTROLS

RCU800 CONTROL PANEL TERMINOLOGY

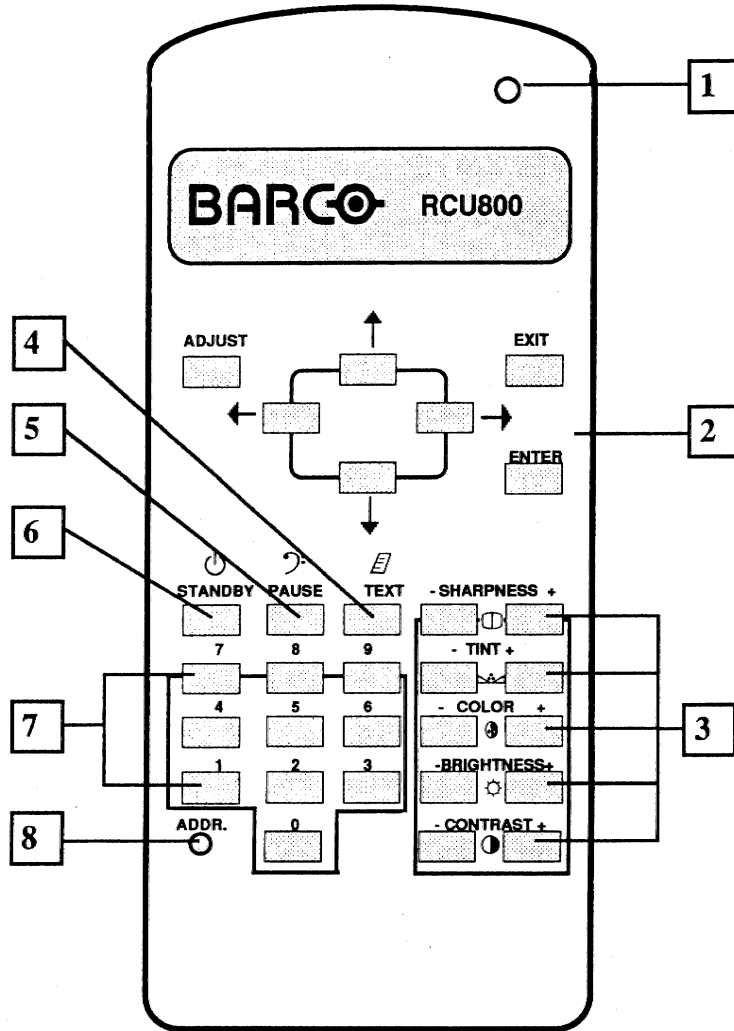

- 3 ANALOG PICTURE CONTROLS** : use these buttons to obtain the desired image analog level (refer to chapter 'Controlling').
- 4 'TEXT' key** : when adjusting one of the picture controls during a meeting, the displayed bar scale can be removed by pressing "TEXT" key first. To redisplay the bar scale on the screen, press "TEXT" key again. "TEXT" key is only active in operational mode.
- 5 'PAUSE' key** : to stop projection for a short time, press "PAUSE" key. The image disappears, but full power is retained for immediate restarting.
- 6 STANDBY**: to stop projection for a longer time without power off, press "STAND-BY" key to switch the projector in the standby position.
- 7 DIGIT BUTTONS**: direct input selection (refer to chapter x)
- 8 ADDRESSED PROJECTOR (between 0 and 9)**: press "address", followed by pressing one digit button, between 0 and 9.

LOCATION AND FUNCTIONS OF CONTROLS

CONTROLLING THE PROJECTOR WITH THE RCU800

Via the REFLECTIVE screen surface

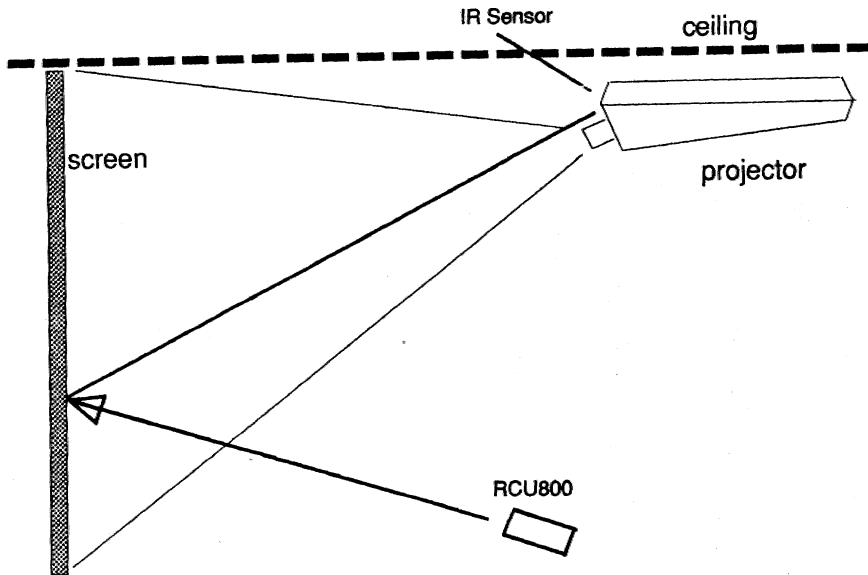

Direct control

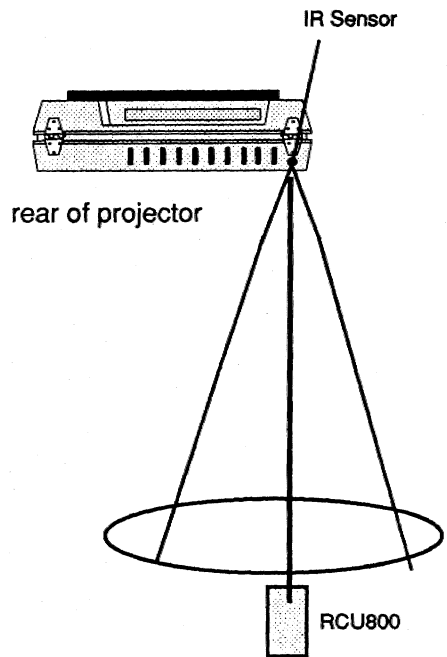
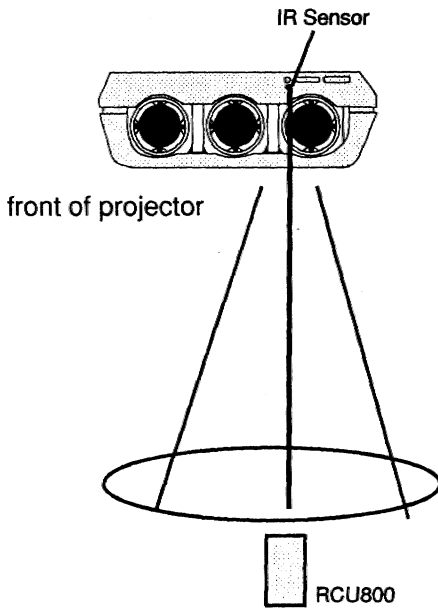

When using the wireless remote control, make sure you are within the effective operating distance. The remote control unit will not function properly if strong light strikes the sensor window or if there are obstacles between the remote control unit and the projector IR receiver.

LOCATION AND FUNCTIONS OF CONTROLS

Notes

POWER (MAINS) CONNECTION

POWER (MAINS) CONNECTION

POWER (MAINS) CONNECTION

1. Power (mains) cord connection

Power (Mains) input : Male power connector at the rear of the projector.

Attention :

Before plugging the female power connector into the male connector on the projector put the connector clamp in the clamp holder.

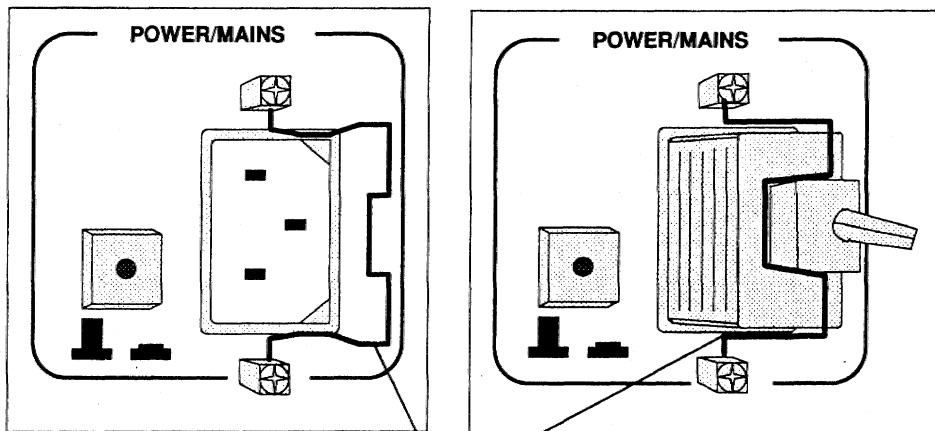
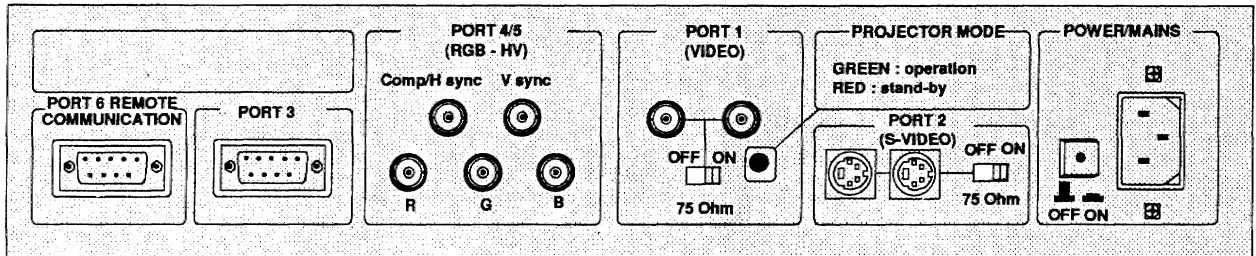

Connector clamp

* *Power check*

Warning

Check by looking through the little window on the top cover if the indicated power voltage corresponds to that of the wall outlet.

If the indication is different from that of the wall outlet, call a qualified technician for power adaptation of the projector.

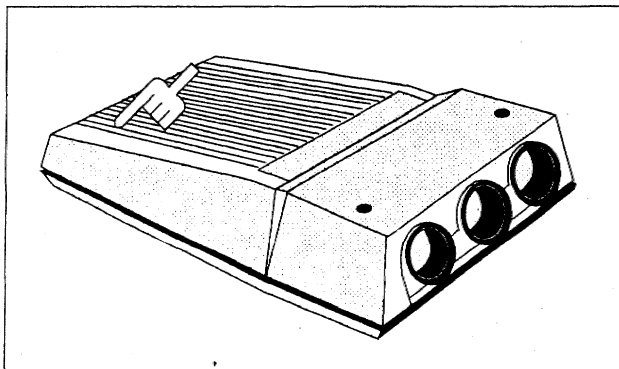

POWER (MAINS) CONNECTION

2. Switching on

The projector is switched ON and OFF using the power (main) switch ON/OFF.

Pressed : ON

Not pressed : OFF



Power indication lamp :
Green : projector in operational mode
Red : projector in stand-by mode

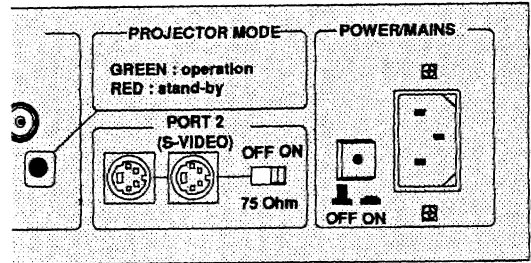

The projector can start now in the 'operational mode' (image displayed) or in the 'stand-by mode', depending on the position of the 'power up' dip switch on the controller unit. This DIP switch is set during installation by a qualified technician. If you want to change this start up mode, call a qualified technician.

POWER (MAINS) CONNECTION

Notes

SOURCE CONNECTIONS

CONNECTIONS

INPUT SOURCES

PERIPHERAL EQUIPEMENT

Signal input connections to a stand alone projector : * Composite Video
 * S-Video
 * RGB TTL
 * RGsB - RGB/S

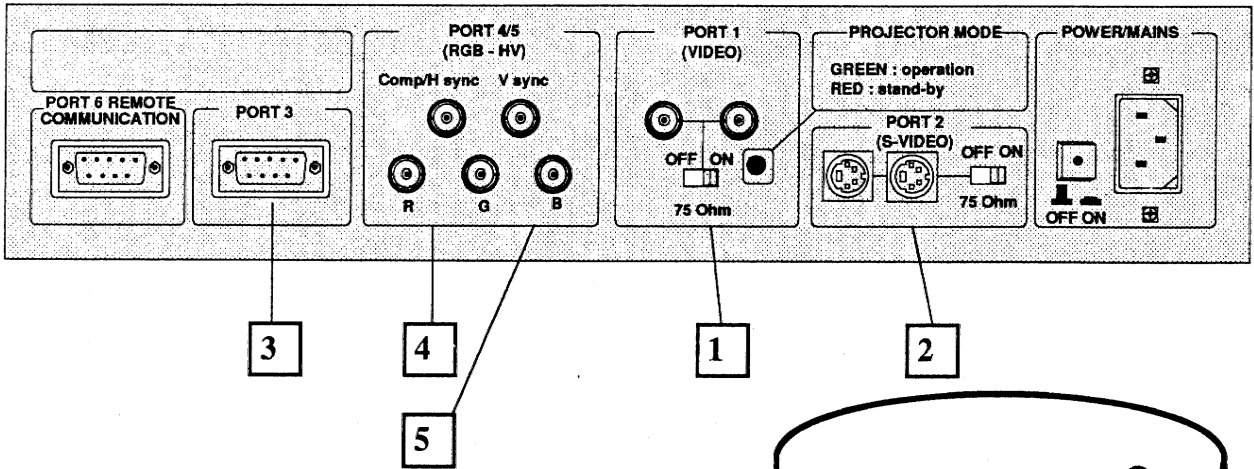

PORT No.	SOURCE No.	PROJECTOR INPUT	PRESS DIGIT BUTTON
1	1	COMP VIDEO	1
2	2	S-VIDEO *	2
3		not used	
4	4	RGsB **	4
5	5	RGB/S ***	5

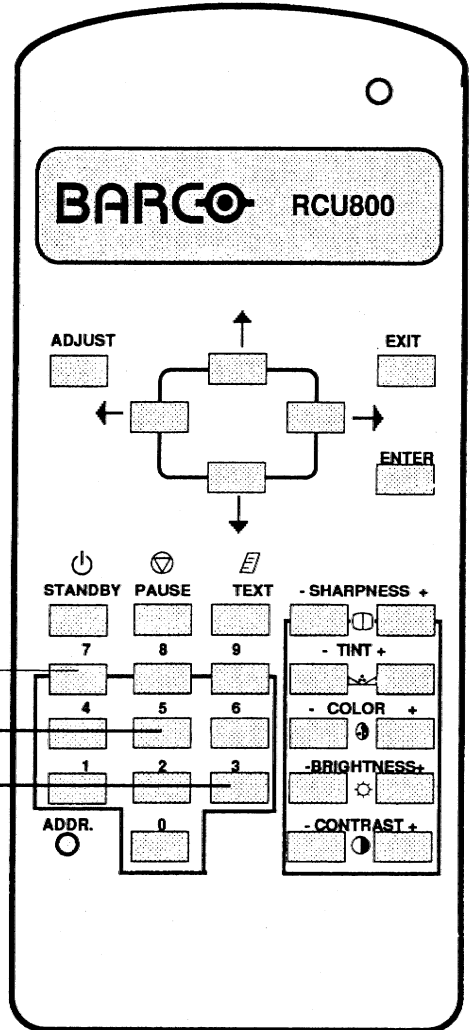

* Input signal Y/C (luma/chroma)
 ** Input signal: R,G and B with sync on G
 *** Input signal: R,G,B and separate sync(S)

EXAMPLES OF CONNECTIONS

Connecting a Composite VIDEO source to port 1

Composite video signal from a VCR, OFF air signal decoder, etc...

COMPOSITE VIDEO INPUT SELECTION: PRESS digit button 1 on the RCU800

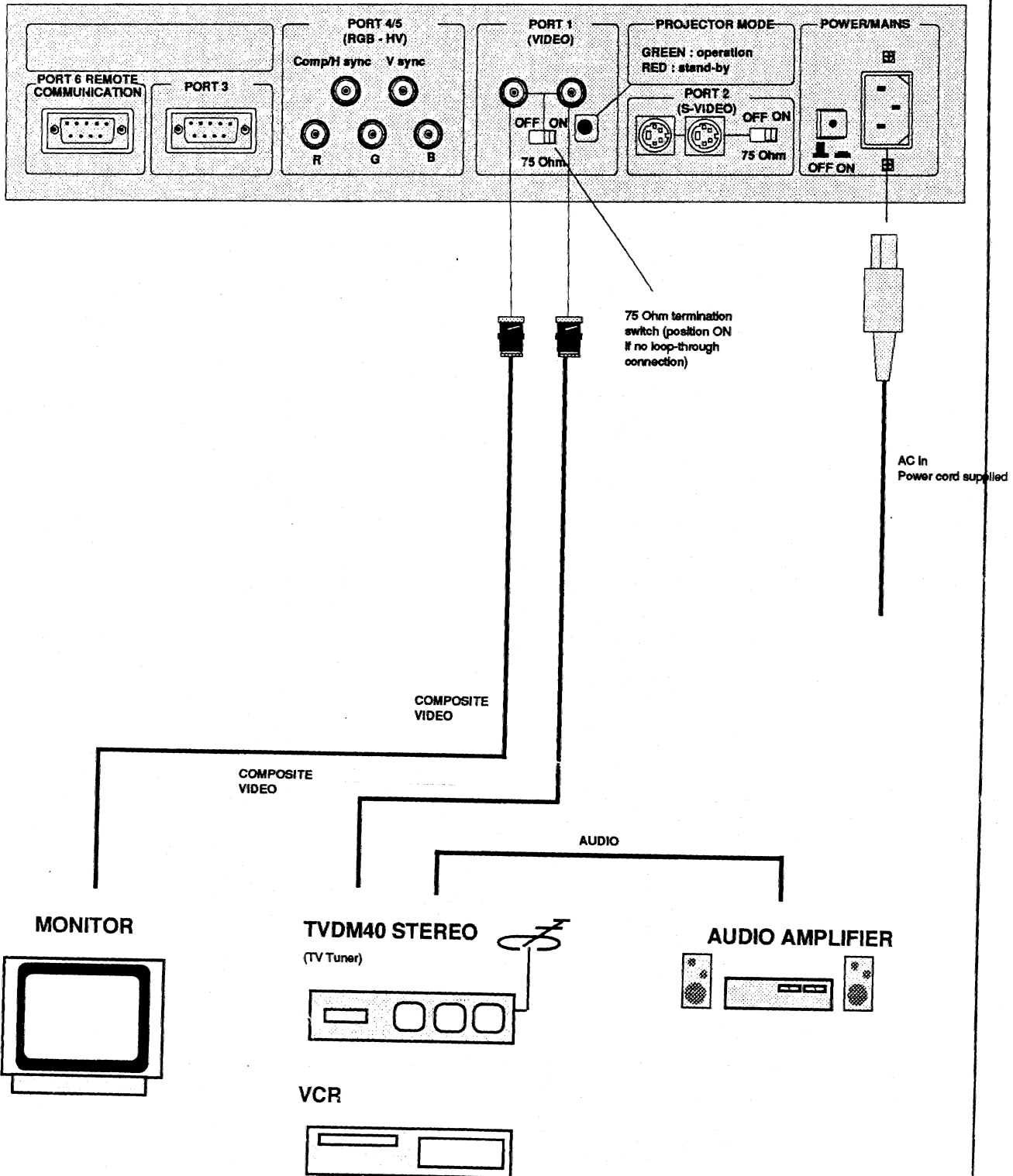

EXAMPLES OF CONNECTIONS

Connecting a S-VIDEO source to port 2

Separated Y-Luma / C -Chroma signal inputs for higher quality playback of Super VHS-signals

S-VIDEO INPUT SELECTION: PRESS digit button 2 on RCU800.

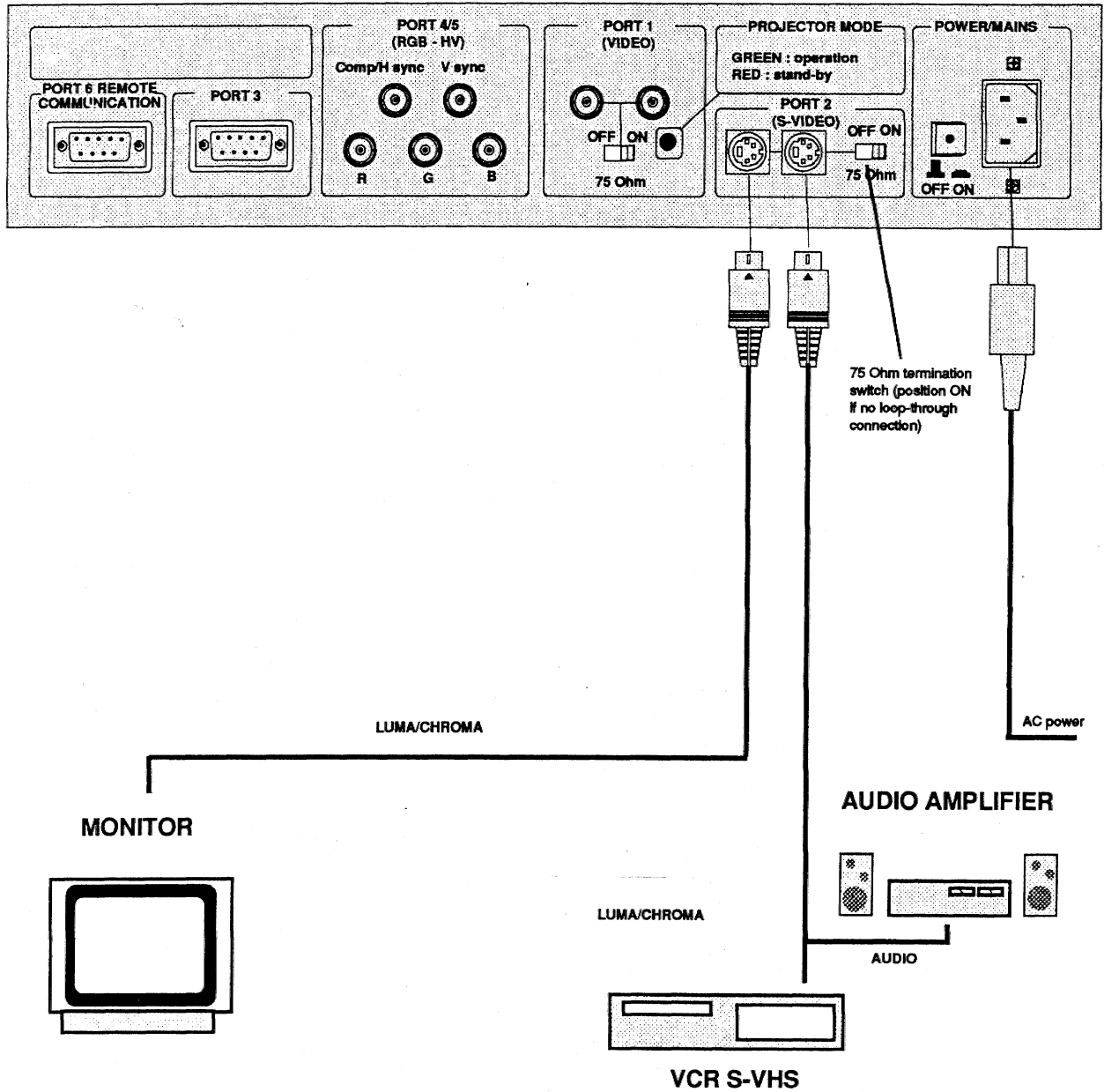

EXAMPLES OF CONNECTIONS

Connecting a RGB Analog source to port 4/5.

RGB analog input terminals with separate H and V sync inputs, with composite sync input or with sync signals on green.

Always use an interface when a computer and local monitor have to be connected to the projector. Interfaces to be applied :

- universal analog interface. Order number 98 26100
- RGB 120 MHz analog interface. Order number 98 26570

RGsB input selection : press digit button 4 on the RCU800
(RGsB : R, G, B signals with sync on GREEN)

RGB/S input selection : press digit button 5 on the RCU800
(RGB/S : R, G, B and separate sync; H- and V- sync or COMP sync)

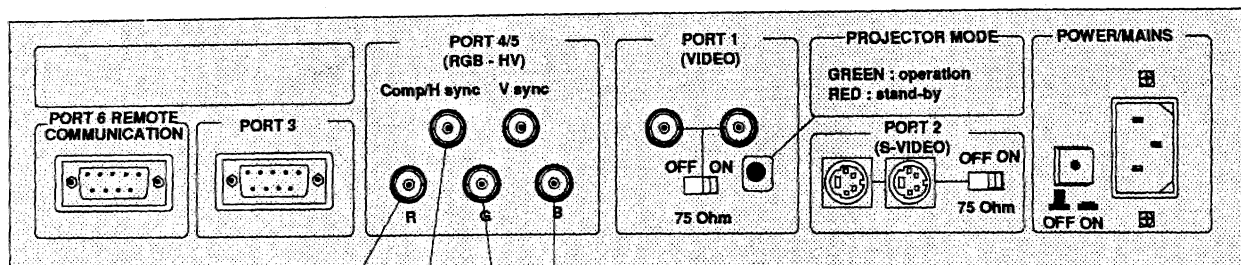

ATTENTION!

The RGB Analog 120 MHz interface has no separate output for vert. sync.

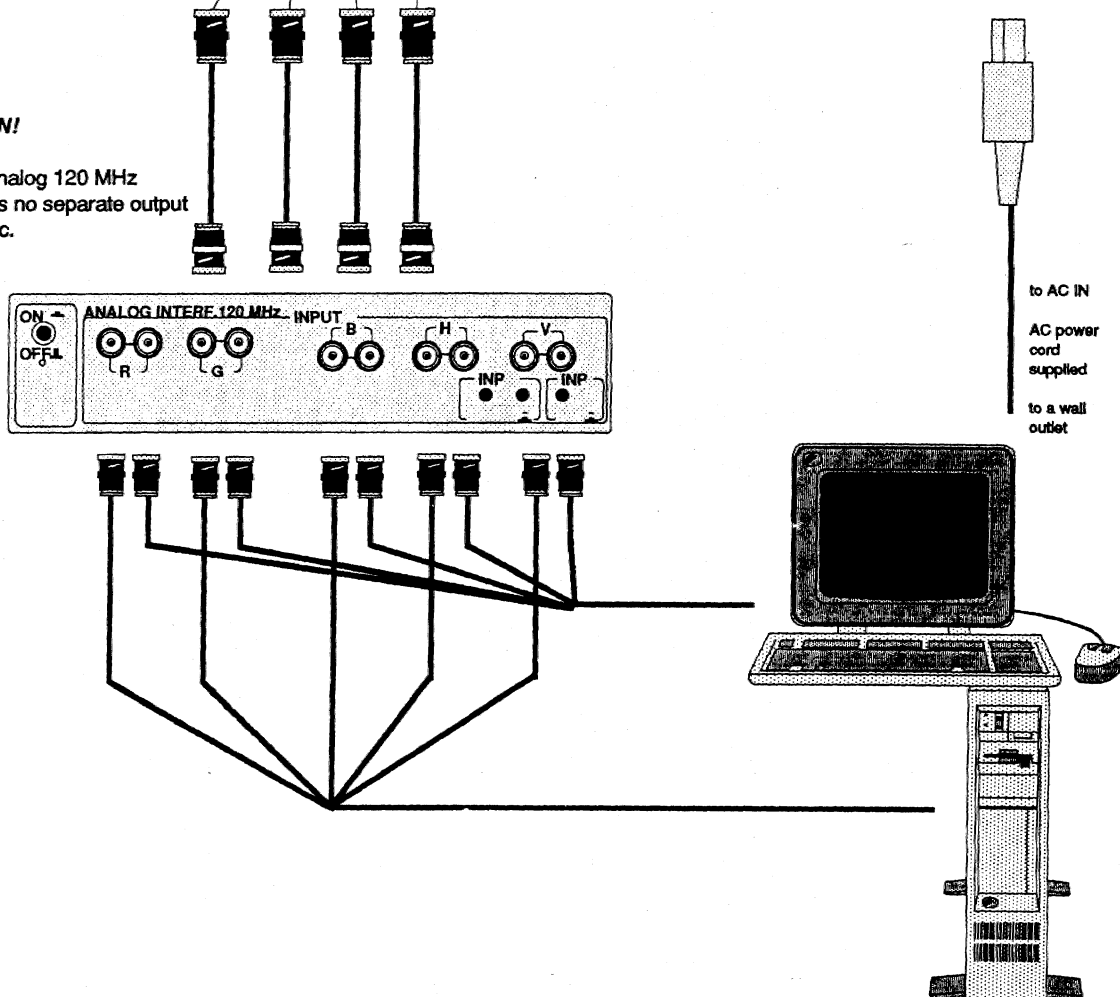

EXAMPLES OF CONNECTIONS

Connecting a HDTV source to the analog inputs of the projector.

Connect your HDTV source via a HDTV interface to the Analog BNC input of the projector.
(BARCO order number : 98 27430)

RGsB INPUT SELECTION: PRESS digit button 4 on the RCU800
(RGsB : R, G, B signals with sync on GREEN)

RGBS INPUT SELECTION : PRESS digit button 5 on the RCU800.
(RGBS : R, G, B and separate sync S)

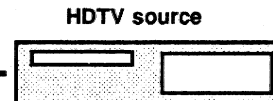
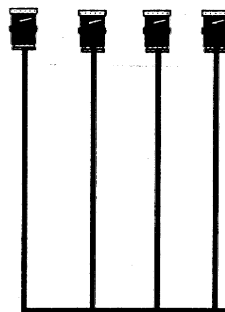
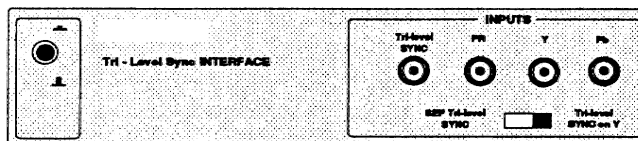
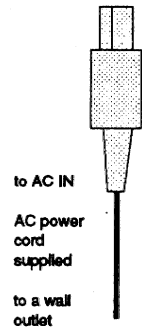
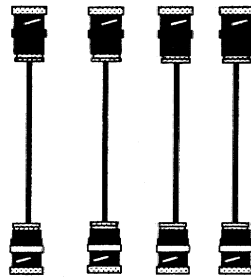
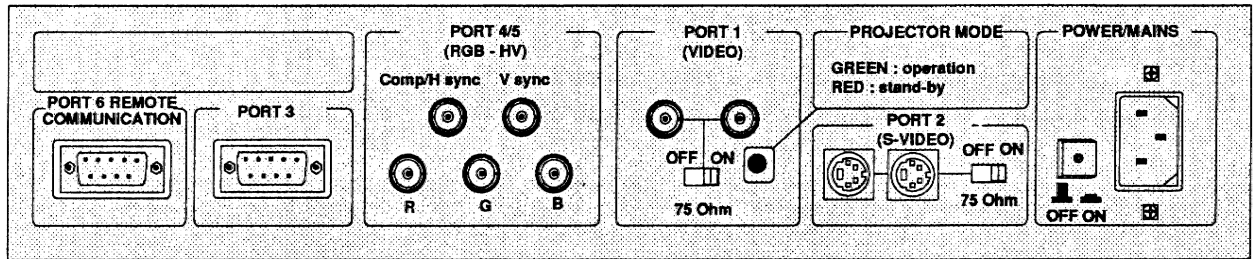

EXAMPLES OF CONNECTIONS

PERIPHERAL EQUIPMENT

Connecting a computer, e.g. IBM PC (or compatible), Apple Macintosh or Workstation to the BARCOVISION 1600.

The BARCOVISION 1600 projector has a RS 232 port that allows it to communicate with a computer. (RS422, 'Macintosh', can be directly connected to the projector's port without any problem if you respect RS 232 distances and baudrates.)

Applications :

Two main applications : remote control and data communications.

a) remote control :

- easy adjustment of projector via IBM PC (or compatible) or MAC connection.
- allow storage of multiple projector configurations and set ups
- wide range of control possibilities
- address range from 0 to 255.

b) data communications :

- sending adjustment data to the projector or copying the adjustment data from the projector to a hard memory device

More information about this feature is included in the 'Control 800' software manual which is delivered together with the software or which can be ordered at BARCO

Connecting a RCVDS 800 to the BARCOVISION 1600.

- Up to 10 inputs with one RCVDS 800 and 90 inputs when RCVDS 800 are linked via the expansion module
- Serial communication with the projector.
- Remote control buttons on the RCVDS 800 to control the BARCOVISION 1600 (source selection and analog settings).
- The selected source number will be displayed on a 2 digit display and the selected input module will be indicated with a LED on the rear.

For more information about the use of the RCVDS 800, consult the RCVDS 800 owner's manual, BARCO order number : 59 75004.

EXAMPLES OF CONNECTIONS

PROJECTOR CONTROLLING

CONTROLLING STAND ALONE PROJECTORS WITH THE RCU800

CONTROLLING CHAINED PROJECTORS WITH THE RCU800

Caution : Do not display a stationary image with high brightness and contrast for longer than 20 min., otherwise you risk damage to the CRT's.

PROJECTOR CONTROL

Stand alone projector

1. The RCU800

The stand alone projector can be controlled by the RCU800; which you can use in three different configurations :

- a) The built in RCU800.
- b) The IR transmission RCU800.
- c) The hardwired RCU800

a) The built in RCU800.

This RCU800 is built to the rear of the projector. To gain access to it, push once on the door cover of the built in RCU and it will open. Now, it is possible to turn the RCU 90°.

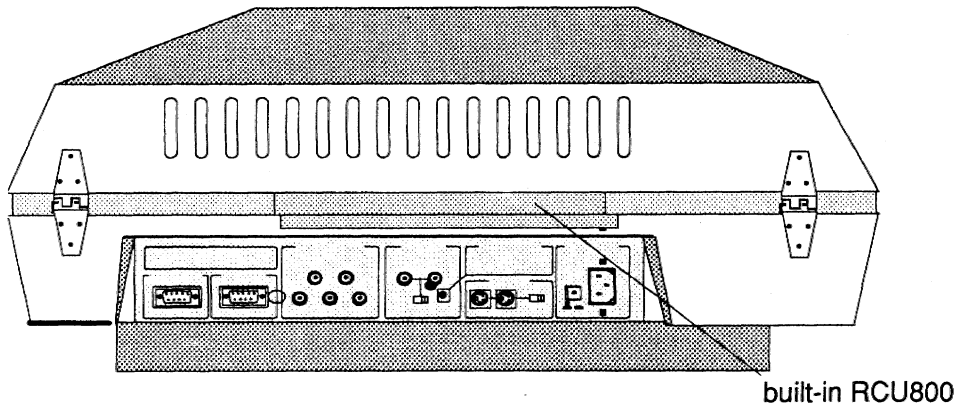

b) The IR transmission RCU800.

This remote control is included with the BARCOVISION 1600. When using this remote control, make sure that the projector address is programmed on the remote control (see § Selecting the address).

c) The hardwired RCU800.

The IR transmission RCU800 may also be used in a hardwired configuration. Plug one end of the remote cable in the connector on top of the RCU800 and the second side in the connector in the front panel of the BARCOVISION 1600 labelled 'remote control'.

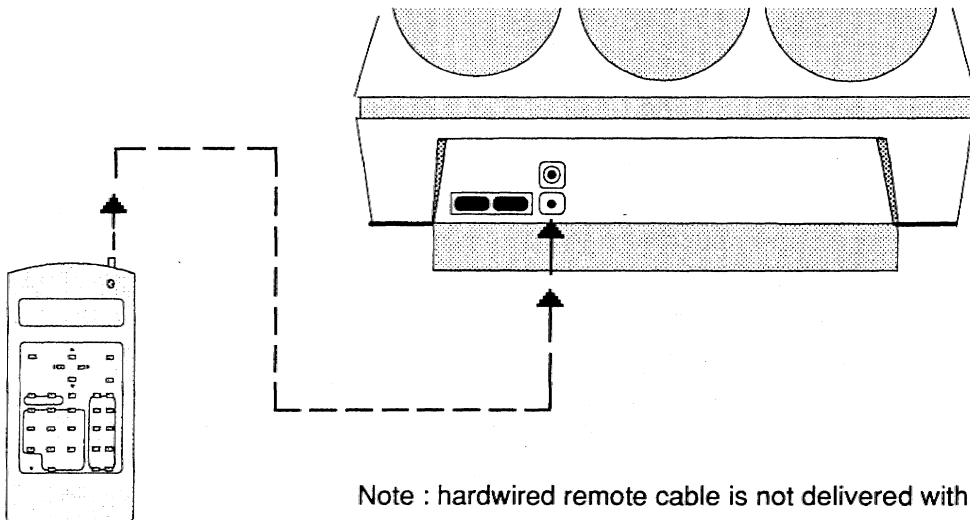

Note : hardwired remote cable is not delivered with the set.

PROJECTOR CONTROL

2. Controlling stand alone projector with the RCU800.

A. Selecting the address.

Every projector requires an individual address. Otherwise, it is not possible to control the projector. The address setting of the projector must be done during the hardware set up by a qualified technician. Once the projector is installed, the RCU800 must be programmed with the address of the the projector it controls.

Address display : When pressing with a pencil or other small object in the hole labelled ADDR on the RCU800, the projector's address will be displayed. To continue, it is necessary to enter an address with the numeric keys, even when that address is the same as the displayed address.

Address programming : The address of an individual projector may be programmed into the RCU800 by keying in the address with the numeric keys after activating 'ADDR' on the RCU800. (With RCU800, the address can only be between 0 and 9).

Zero address : If the RCU800 is programmed with an address of 0 (zero), it will control a projector regardless of the projector's address. This feature allows multiple projectors with differing addresses to be controlled by a single RCU800.

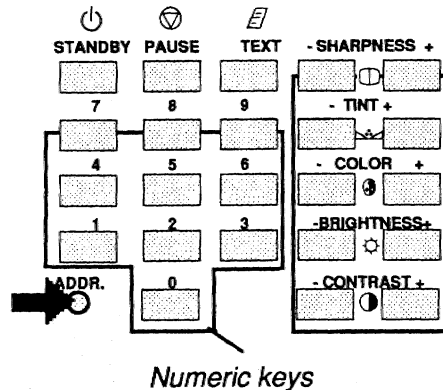

B. Selecting an input source.

SOURCE Nr	PROJECTOR INPUT	PRESS DIGIT BUTTON
1	VIDEO	1
2	S-VIDEO *	2
3	not used	
4	RGsB **	4
5	RGB/S ***	5

With the numeric keys, 1 to 5, on the RCU800, it is possible to select one of the five inputs.

When a valid and available source is selected, there will be information displayed on the screen about that source. This information includes :

- source number
- horizontal frequency
- vertical frequency

- * Input signal Y/C (luma/chroma)
- ** Input signal: R,G and B with sync on G
- *** Input signal: R,G,B and separate sync's

Source information in example :
 source 02 = S-Video input signal with horizontal frequency of 15.6 kHz and a vertical frequency of 50 Hz.

SOURCE 02
 Fh = 15.6 kHz
 Fv = 50 Hz

PROJECTOR CONTROL

When the entry is a not valid source number, a warning appears on the screen : 'invalid key entry'.

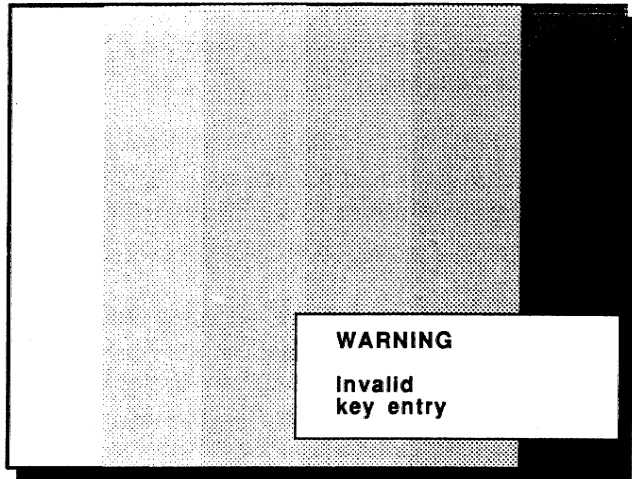

When a valid source number is selected, the projector will display this source or it will wait on the selected-source number until the source becomes available. A message 'source not available' will be displayed for a short time.

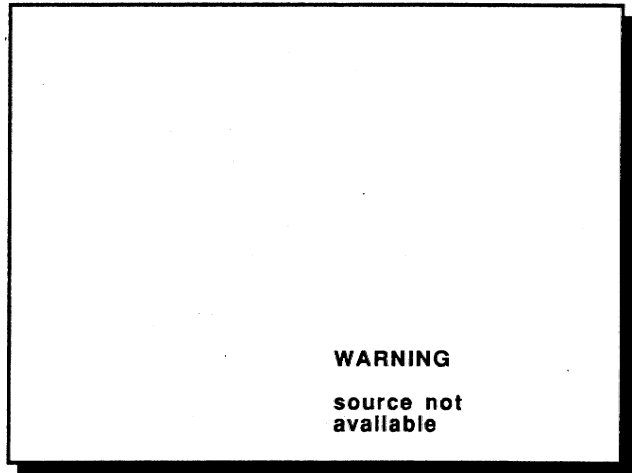

C. Analog picture controls

When an analog picture control is pressed, a bar scale and a number below the bar scale (between 0 and 100) appear on the screen with the function name of the control, e.g. "brightness" above it. The length of the bar scale and the number (between 0 and 100) indicate the current setting for this source. The bar scale changes as the + or - buttons of the control are pressed.

The appearance of the text, bar scale and number can be prevented by pressing the **'TEXT'** key on the RCU800. This button acts as a toggle switch, switching between text 'ON' and 'OFF' each time the button is pressed. The latest position is memorized and is recalled every time this source is chosen, even when the power to the projector is switched OFF and ON again.

The analog picture controls can be adjusted with the RCU800 in *'adjustment mode'* as well as in *'operational mode'*.

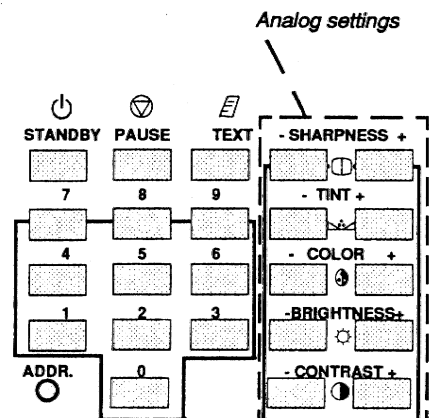

PROJECTOR CONTROL

a) Brightness control

Brightness control for Video, S-video and RGB sources.

A correct 'brightness' setting is important for good color reproduction.

Adjust the Brightness with the + button and - button until the darkest parts of the picture appear black.

A bar scale and number below the bar scale (between 0 and 100) give a visual indication on the screen of the current brightness setting while pressing the + or - buttons. If the bar scale is not visible on the screen, press 'TEXT' key once and retry the + or - keys.

The bar scale and numeric indicator increase when pressing on the + button (higher brightness) and decrease when pressing on the - button (lower brightness).

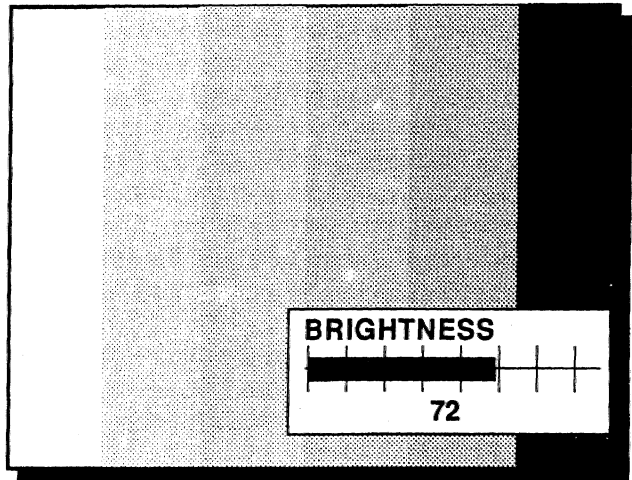

b) Contrast control.

Contrast control for Video, S-video and RGB sources.

A correct 'contrast' setting is important for good color reproduction.

Adjust the contrast to the level you prefer, according to room lighting conditions.

A bar scale and a number below the bar scale (between 0 and 100) give a visual indication on the screen of the current contrast setting while pressing the + or - buttons. If the bar scale is not visible on the screen, press 'TEXT' key once and retry with the + or - keys.

The bar scale and numeric indicator increase when pressing the + button (higher contrast) and decrease when pressing on the - button (lower contrast).

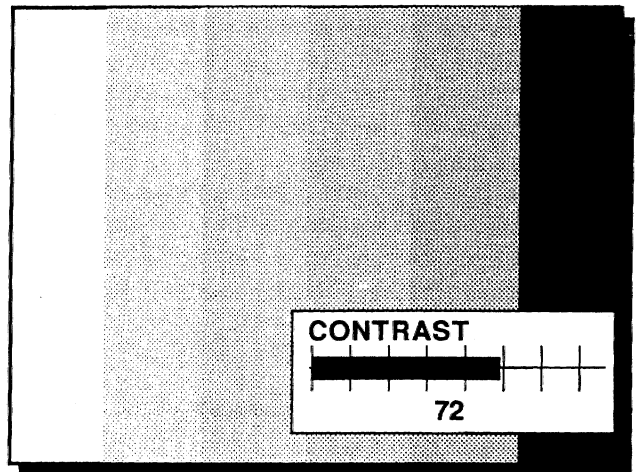

c) Color saturation

Color saturation control for Video and S-video.

Adjust the color intensity of the picture. Use the + and - button on the remote control panel.

A bar scale and a number below the bar scale give a visual indication on the screen of the current color setting while pressing of the + or - buttons. If the bar scale is not visible on the screen, press 'TEXT' key once and retry the + or - keys.

The bar scale and numeric indicator increase when pressing on the + button (richer colors) and decrease when pressing the - button (lighter colors).

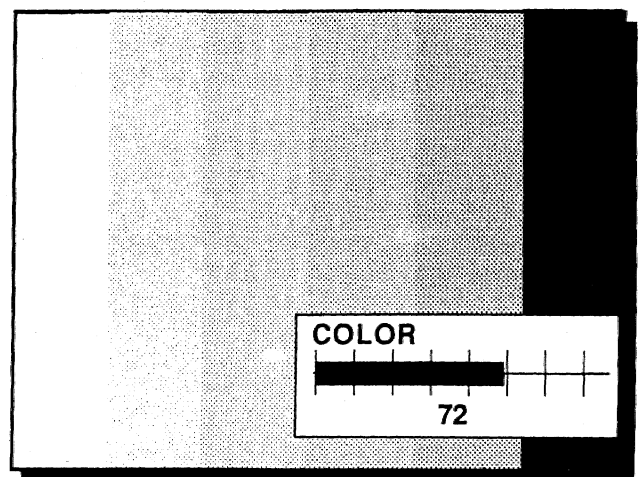

d) Tint control

Tint control for Video and S-video.

This control is effective only when using the NTSC 4.43 or NTSC 3.58 system.

A bar scale and number below the bar scale (between 0 and 100) give a visual indication on the screen of the current tint setting while pressing the + or - buttons. If the bar scale is not visible on the screen, press the 'TEXT' key once and retry the + or - keys.

The bar scale and numeric indicator increase when pressing on the + button and decrease when pressing the - button.

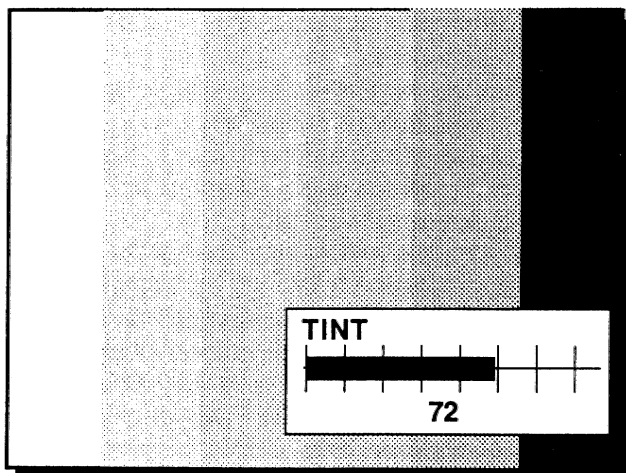

e) Sharpness control

Sharpness control for Video and S-video.

A bar scale and a number below the bar scale (between 0 and 100) give a visual indication on the screen of the current sharpness setting while pressing the + or - buttons. If the scale bar is not visible on the screen, press 'TEXT' key once and retry the + or - keys.

The bar scale and numeric indicator increase when pressing on the + button (sharper picture) and decrease when pressing on the - button (softer picture).

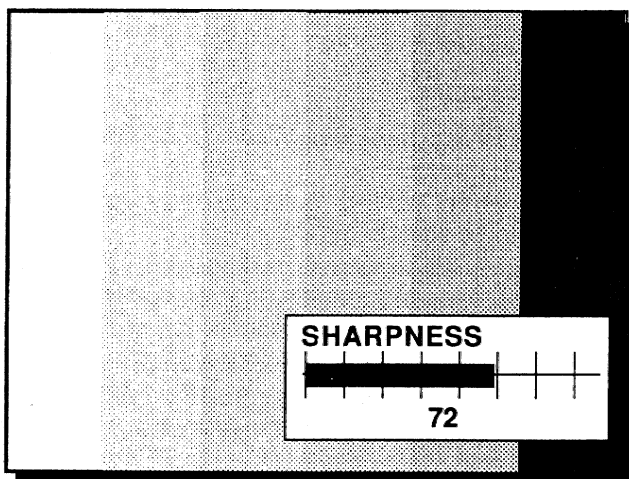

f) Bandwidth limiting

With the sharpness keys on the RCU800, it is possible to limit the bandwidth of the RGB amplifier. The bandwidth is maximum when set on zero, and minimum when set on 100. The setting in a new block will be set to zero during the creation of that block.

A bar scale and a number below the bar scale (between 0 and 100) give a visual indication on the screen of the current bandwidth setting while pressing the + or - buttons.

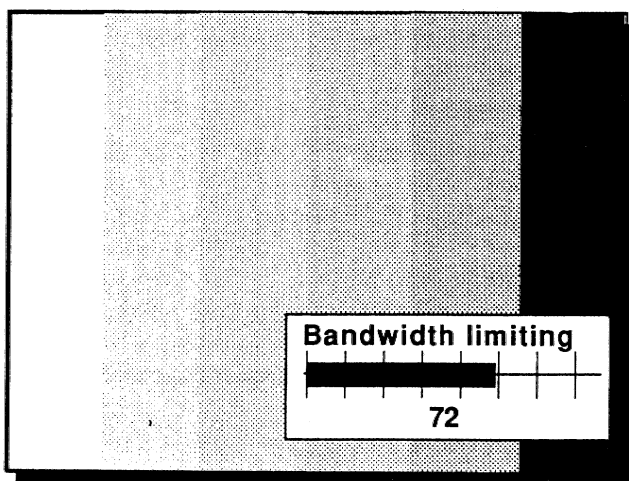

PROJECTOR CONTROL

Chained projectors

1. The RCU800

Use the standard RCU800 to control chained projectors. For address setting, source selection and analog controls see § Controlling chained projectors.

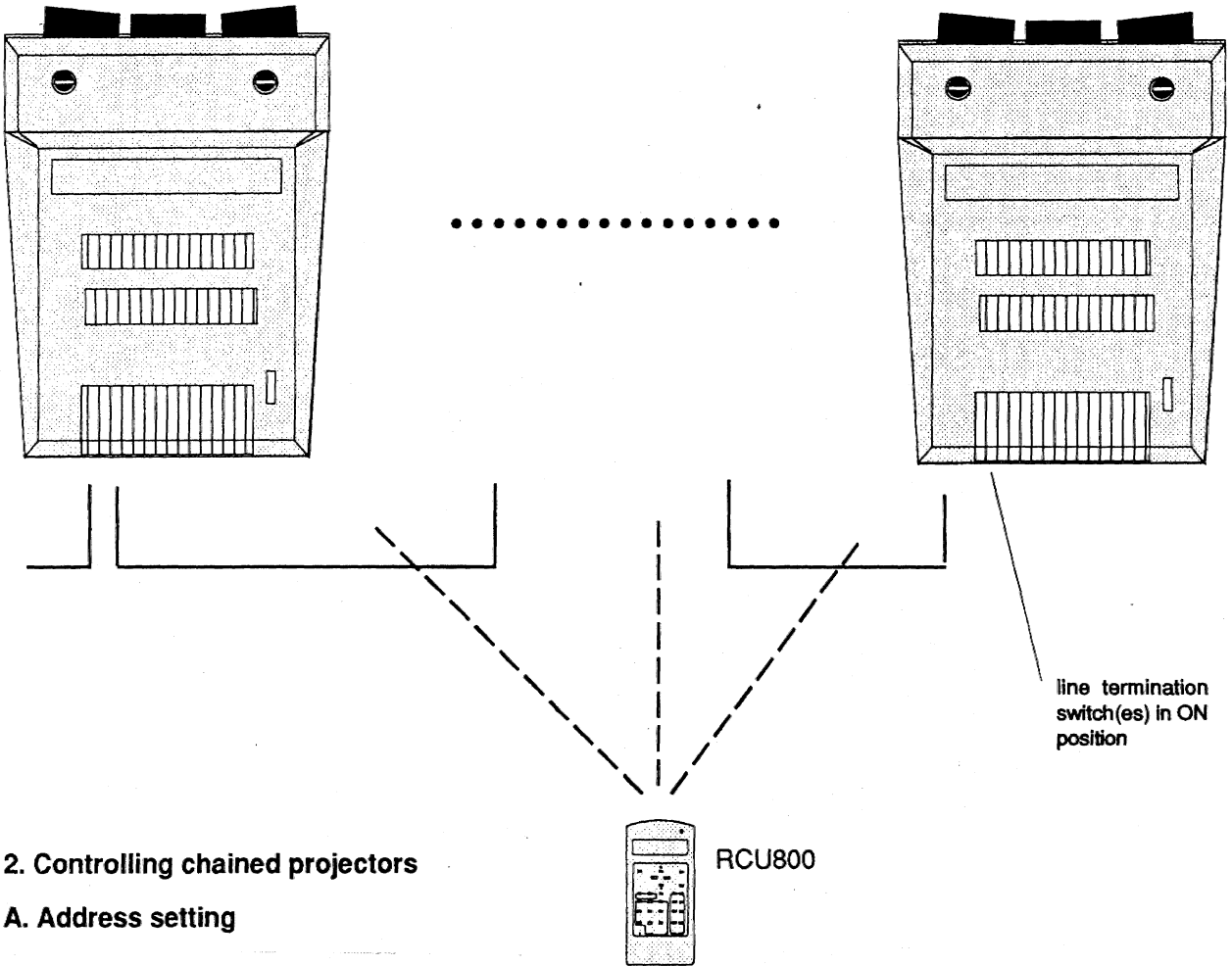

2. Controlling chained projectors

A. Address setting

Note :

Every projector requires an individual address. Otherwise, it is not possible to control the projector. The address setting of the projector must be done during the hardware set up by a qualified technician. Once the projector is installed, the RCU800 must now also be programmed with the address of the projector's controls.

Address display : When pressing with a pencil or other small object in the hole labelled ADDR on the RCU800, the projector address will be displayed. To continue, it is necessary to enter an address with the numeric keys, even when that address is the same as the displayed one.

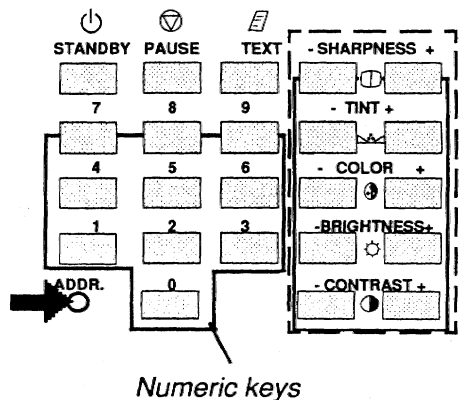

PROJECTOR CONTROL

Address programming : The RCU800 is programmable with that individual projector address or with its 'zero address'.

To program the address, depress the 'ADDR' button and key in the address with the numeric keys on the RCU800 itself.

Zero address : master address, independent the hardware set up, for controlling all the BARCOVISION 1600's at once. So, the chain of projectors is addressable with the 'zero address' and an individual projector in the chain is addressable with its individual address (set during projector set up). When using that zero address, program the RCU800 as explained above.

B. Selecting an input source

As the projectors have to display the same input source, the RCU800 must be programmed with the 'zero address' before selecting an input source.

SOURCE Nr	PROJECTOR INPUT	PRESS DIGIT BUTTON
1	COMP. VIDEO	1
2	S-VIDEO *	2
3	not used	
4	RGsB **	4
5	RGB/S ***	5

* Input signal Y/C (luma/chroma)

** Input signal: R,G and B with sync on G

*** Input signal: R,G,B and separate sync's

Attention

Once address '0' is pressed all projectors will be controlled until a new address is entered on the RCU800. Once this new address is entered, only the projector with this address will follow the new instructions.

C. Analog picture controls

With the RCU800 programmed with the 'zero address' all BARCOVISION 1600 will be controlled in the same way. When one projector has to be adjusted, use the individual projector address to control this specific BARCOVISION 1600.

For explanation about the analog controls, see 'Stand alone projector controlled with the RCU800'.

START UP OF THE ADJUSTMENT MODE

ENTERING THE ADJUSTMENT MODE (FLOW CHART)

ADJUSTMENT MODE

START UP OF THE ADJUSTMENT MODE

Entering the adjustment mode.

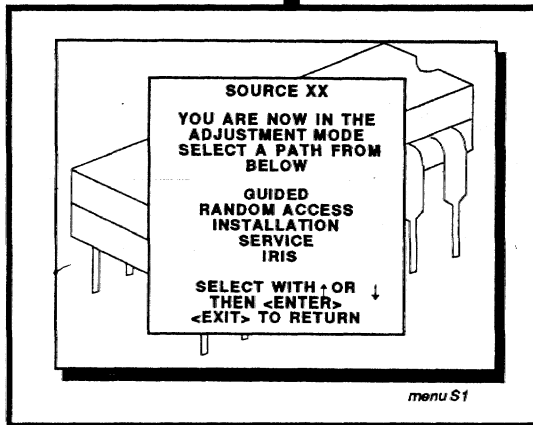
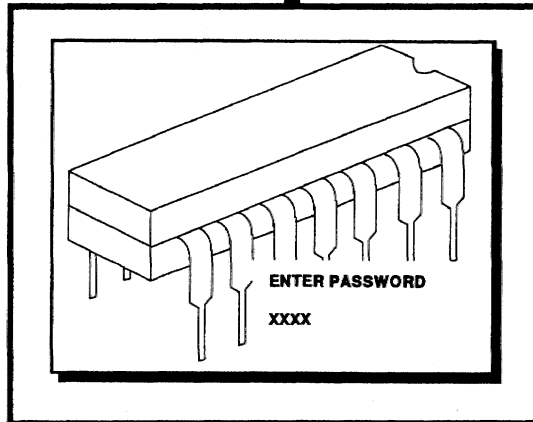

RANDOM ACCESS OR
GUIDED ADJUSTMENT

SERVICE

INSTALLATION

(only for a qualified technician)

IRIS

(only with an IRIS800)

START UP OF THE ADJUSTMENT MODE

ADJUSTMENT MODE

All picture geometry and convergence adjustments are made while in the 'Adjustment Mode'. To enter the Adjustment Mode, press the **ADJUST** key on the RCU800.

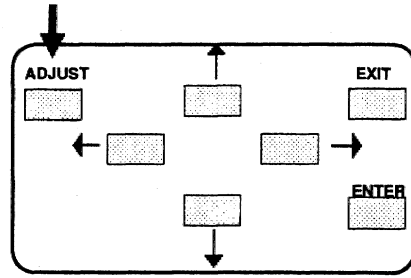

The projector asks you to enter your password.

Your password contains 4 digits. Enter the digits with the numeric keys on the RCU800.

Example : 2 3 1 9

For each digit entered, a "X" appears on the screen under the displayed text 'enter password'.

When your password is correct, you get access to the 'Adjustment mode'.

When the entered password is wrong, the following message will be displayed: 'invalid code entry'.

The projector stays in operational mode.

Remark : when no password is entered within the first minute, the projector automatically returns to operational mode.

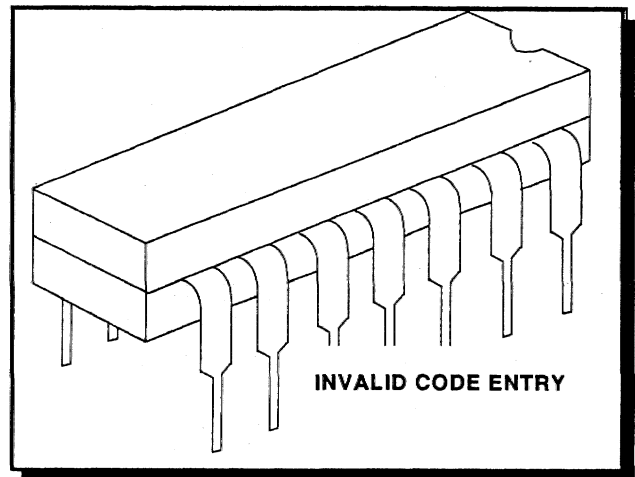
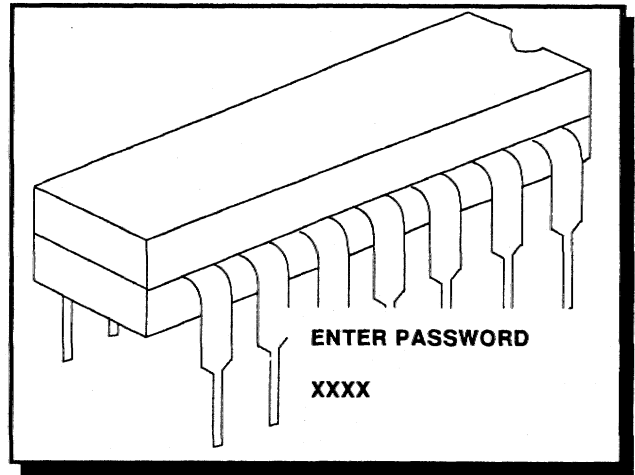

Factory programmed password :

1990

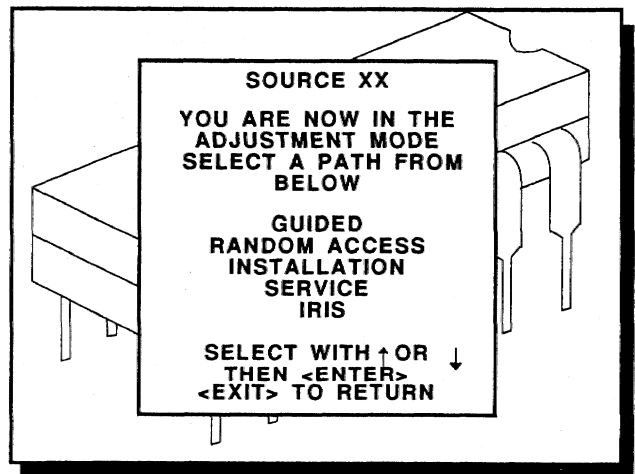

menu S1

START UP OF THE ADJUSTMENT MODE

You are now in the 'Adjustment mode'. The arrow keys are used to make menu selections and also vertical and horizontal adjustments. The **ENTER** and **EXIT** keys are used to move forward and backward through the menu structure. The **ADJUST** key can be used to terminate the adjustment mode while a path selection menu (head menu) is displayed.

There are 5 possible paths to follow once in the Adjustment Mode. They are:

INSTALLATION - Installation should be selected if the projector has been relocated and/or a different screen size is desired.

When selecting 'INSTALLATION', the user or operator will be warned to call a qualified technician to perform the installation procedure (see example of projected warning at the bottom of this page).

GUIDED - Guided should be selected if the user intends to perform a complete alignment of the projected image. All of the necessary geometry and convergence adjustments are made in a predetermined sequence.

RANDOM ACCESS - Random Access should be selected if the user intends to make only a few adjustments.

SERVICE - Service should be selected if the user intends to delete blocks, change password or apply for information.

IRIS - This selection will only be available when the autoconvergence unit IRIS 800 is connected to the projector.

While in Guided or Random Access adjustment Mode, the user may use an external source, an internally generated genlocked pattern or an internally generated multifrequency cross hatch pattern as a setup pattern.

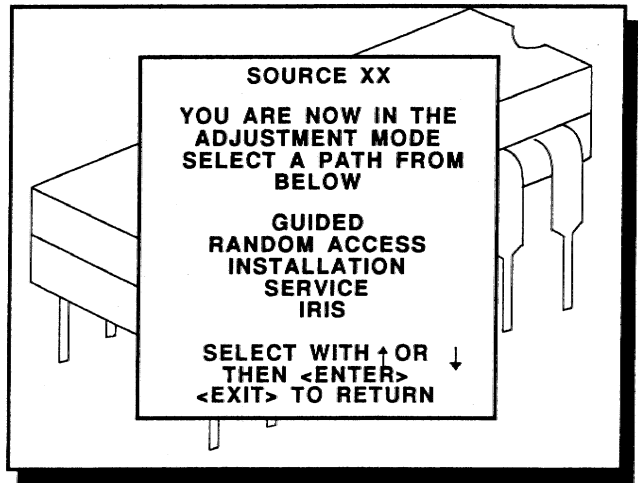

menu S1

Warning during the start up of the installation mode

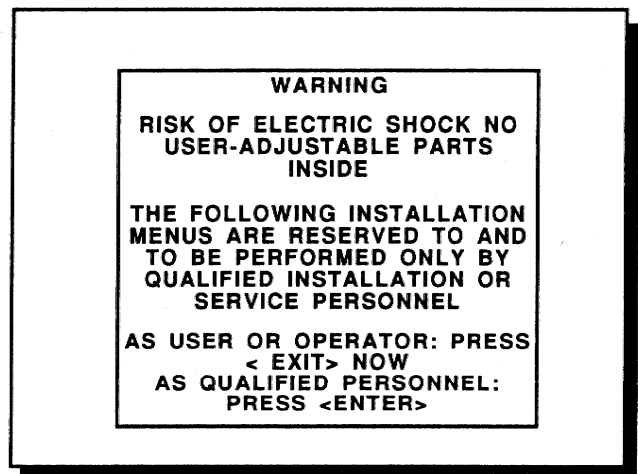

warning

GUIDED ADJUSTMENT MODE

GUIDED ADJUSTMENT MODE

Start up of the guided adjustment mode.

- Use the arrow keys to highlight *GUIDED* on menu S1 and then press **ENTER**.

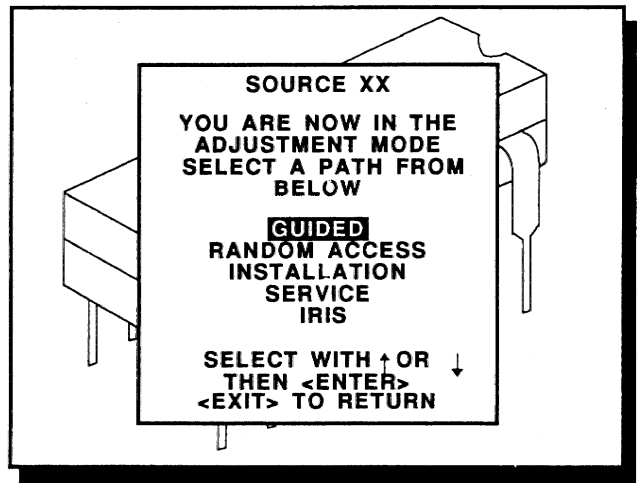

menu S1

<ENTER> continues to Setup Pattern Selection (Menu S2 or S3)
<EXIT> returns to operational mode.

GUIDED ADJUSTMENT MODE

Overview flow chart 'Guided Adjustment' procedure

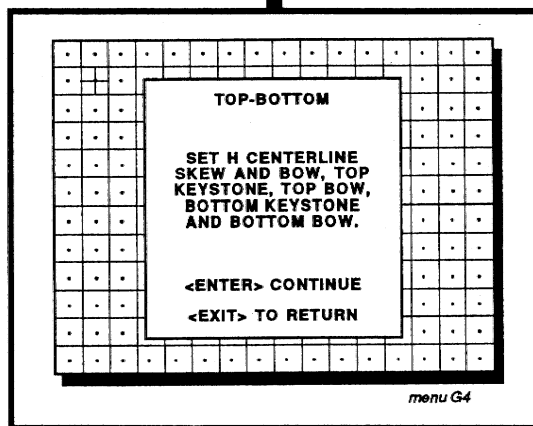
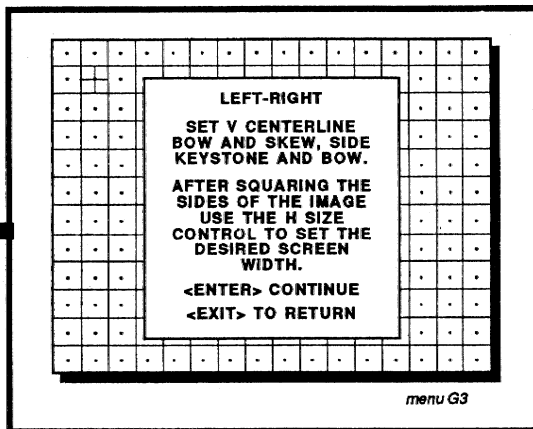
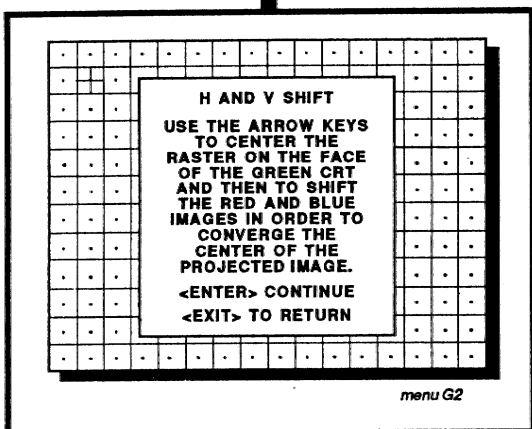
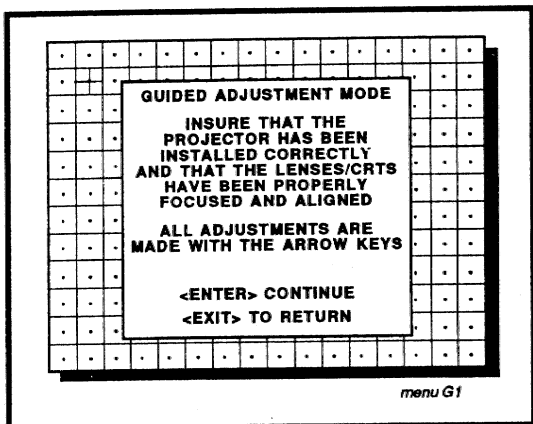

SIZE-LINEARITY

ADJUST THE H SIZE,
V LINEARITY AND
V SIZE IN ORDER TO
SET THE DESIRED
IMAGE DIMENSIONS

USE THE H PHASE
CONTROL TO SHIFT
THE IMAGE WITH
RESPECT TO THE
RASTER

<ENTER> CONTINUE
<EXIT> TO RETURN

menu G5

CONVERGENCE

START WITH RED ON GREEN,
THEN BLUE ON GREEN. USE
THE ARROW KEYS TO MAKE
HORIZONTAL AND VERTICAL
CONVERGENCE ADJUSTMENTS
IN THE AREA INDICATED BY
THE BOX. <ENTER> WILL
MOVE THE BOX TO THE NEXT
AREA TO BE CONVERGED AND
<EXIT> WILL MOVE IT BACK
TO THE LAST AREA.

<ENTER> CONTINUE
<EXIT> TO RETURN

menu G6

BLANKING

ADJUST THE TOP,
BOTTOM, LEFT AND
RIGHT BLANKING
IN ORDER TO FRAME
THE PROJECTED
IMAGE ON TO THE
SCREEN.

THIS PROCEDURE
WILL CONCLUDE THE
GUIDED ADJUSTMENT
SEQUENCE.

<ENTER> CONTINUE
<EXIT> TO RETURN

menu G7

GUIDED ADJUSTMENT MODE

Selecting Setup Pattern

If an external source is connected to the projector, Menu S2 will be displayed. Use the arrow keys to highlight the desired setup pattern and then press **ENTER**.

Genlocked pattern : internally generated cross hatch pattern, locked on the external source.

Internal # pattern : internally generated cross hatch pattern and locked on internal generated sync signals. (No external source necessary)

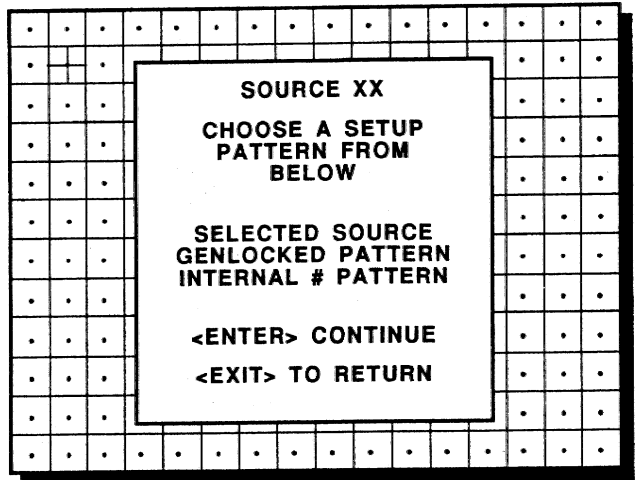

menu S2

<ENTER> continues to Guided Adjustment Mode (Menu G1) or Internal # Pattern Selection (Menu S4)
<EXIT> returns to Path Selection (Menu S1)
<ADJUST> returns to operational mode

If no external source is connected to the projector, Menu S3 will be displayed. Press **ENTER** to select the internally generated cross hatch pattern.

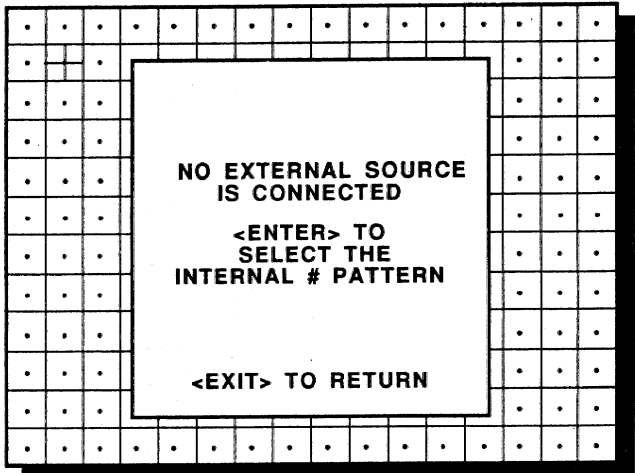

menu S3

<ENTER> continues to Internal # Pattern Selection (Menu S4)
<EXIT> returns to Path Selection (Menu S1)

The menus in this manual are created for an external source, connected to one of the inputs, and the 'Genlocked pattern' is selected.

Internal Cross Hatch Pattern

Menu S4 will be displayed if the internal cross hatch pattern has been selected. The table below lists the 8 factory preset frequencies available.

Use the arrow keys to highlight the desired cross hatch frequency and then press **ENTER**.

- STD: Fh = 15.6 KHz Fv = 50 Hz
- CGA: Fh = 15.7 KHz Fv = 60 Hz
- HD1: Fh = 31.2 KHz Fv = 50 Hz
- HD2: Fh = 31.5 KHz Fv = 60 Hz
- PR1: Fh = 33.7 KHz Fv = 60 Hz
- PR2: Fh = 35.0 KHz Fv = 50 Hz
- PR3: Fh = 16.6 KHz Fv = 70 Hz
- PR4: Fh = 31.2 KHz Fv = 100 Hz

It is possible to store user defined cross hatch frequencies in PR1 - PR4. Follow the steps below to program a custom cross hatch frequency.

1. Highlight the desired storage location (PR1 - PR4) on menu S4.
2. Press **TEXT** to reprogram.
3. Use the arrow keys to select the digits to be changed..
4. Reprogram the desired horizontal frequency as XX.X kHz and the vertical frequency as XXX Hz using the numeric keys.
5. Press **ENTER** to confirm.

Example: Desired cross hatch frequency:

Fh = 34.8 KHz
Fv = 60 Hz

Use the arrow keys to highlight the desired storage location (PR1-PR4) and press **TEXT**. The reprogram menu appears on the screen. Use the arrow keys to go to the first digit of the horizontal frequency and press

3 4 8 0 6 0 <ENTER>

Note : always enter 6 digits. Use if necessary a 0 before the first significant digit of the vertical frequency.

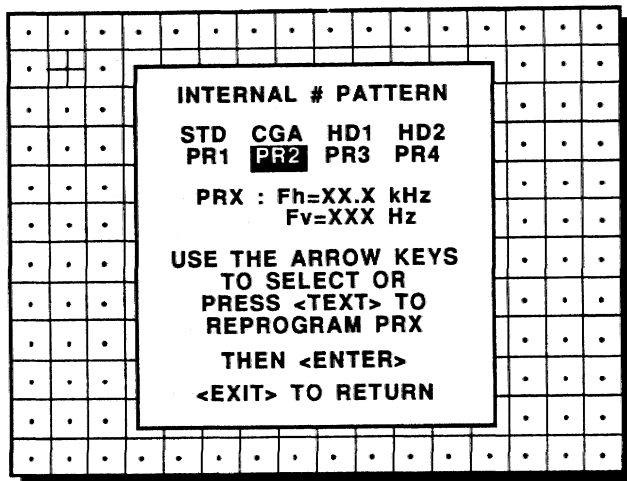

menu S4

<ENTER> continues to Guided Adjustment Mode (Menu G1)
<EXIT> returns to Setup Pattern Selection (Menu S2 or S3)
<TEXT> gives the reprogram menu (Menu S4bis)

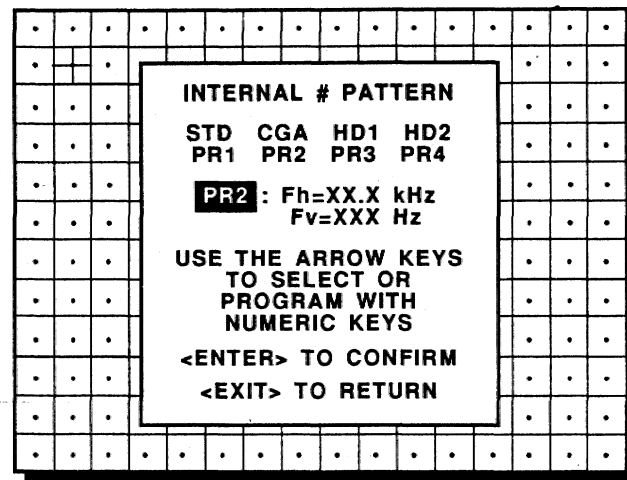

menu S4

<ENTER> confirms your entry and continues to Guided Adjustment mode (Menu G1)
<EXIT> returns to Setup Pattern Selection (Menu S2 or S3)

GUIDED ADJUSTMENT MODE

Note: Before continuing, insure that the lenses are properly focused and that the CRT projection angle is correctly adjusted. If any misalignment is noticed, consult a qualified service technician.

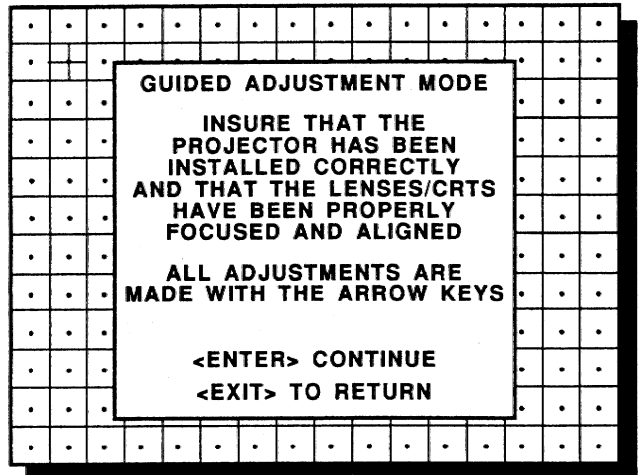

menu G1

<ENTER> continues to Horizontal and Vertical Shift (Menu G2)
<EXIT> returns to Setup Pattern Selection (Menu S2) or Internal # Pattern Selection (Menu S4)
<ADJUST> returns to operational mode

GUIDED ADJUSTMENT MODE

Raster Centering on Green CRT Faceplate

The green raster must be centered both horizontally and vertically on the center of the CRT surface. To center the green raster, look into the green lens and use the arrow keys to move the raster.

CAUTION

It is necessary to look into the lenses to perform the following adjustments. To avoid eye discomfort while looking into the lenses, reduce the contrast and gradually increase the brightness level until the raster becomes visible.

To begin the adjustment, press the **ENTER** key.

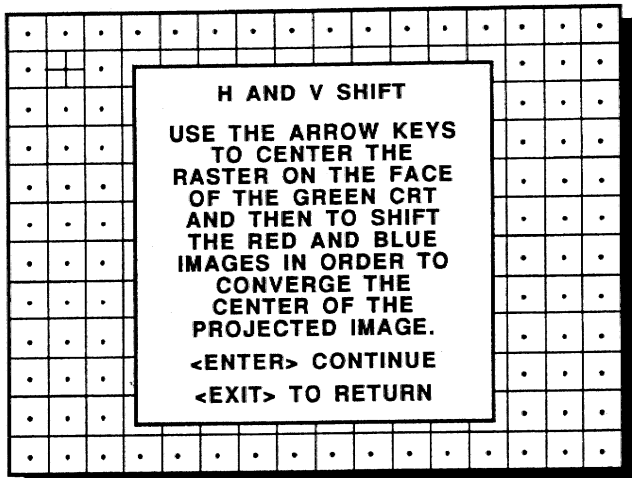

H AND V SHIFT
USE THE ARROW KEYS TO CENTER THE RASTER ON THE FACE OF THE GREEN CRT AND THEN TO SHIFT THE RED AND BLUE IMAGES IN ORDER TO CONVERGE THE CENTER OF THE PROJECTED IMAGE.
<ENTER> CONTINUE
<EXIT> TO RETURN

menu G2

<ENTER> continues to Green Raster Shift
<EXIT> returns to Guided Adjustment Mode (Menu G1)
<ADJUST> returns to operational mode

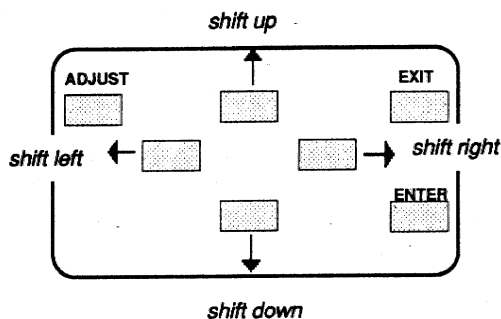
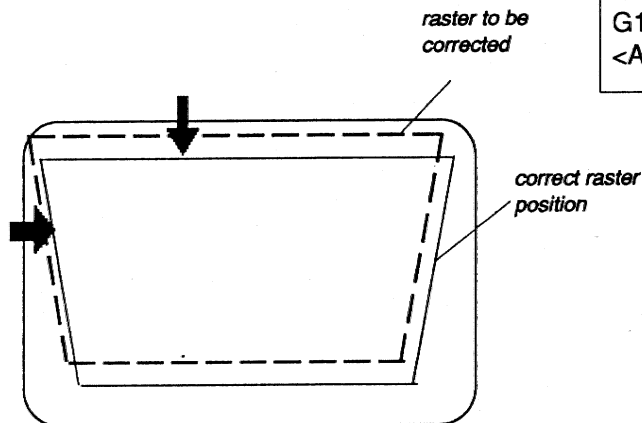

After centering the green raster, press the **ENTER** key to continue.

<ENTER> continues to Red Raster Shift
<EXIT> returns to Horizontal and Vertical Shift (Menu G2)

Warning : In order to ensure maximum CRT longevity and to avoid CRT damage, do not shift the raster outside the phosphor area of the CRT.

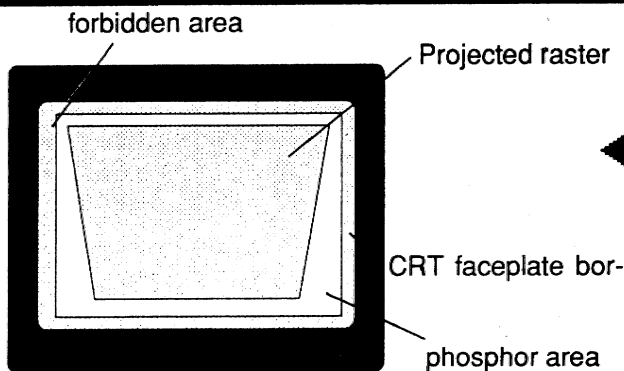

Correct raster position on CRT faceplate

GUIDED ADJUSTMENT MODE

Shifting Red and Blue on Green

Use the arrow keys to shift the red image until the center coincides with the center of the green image.

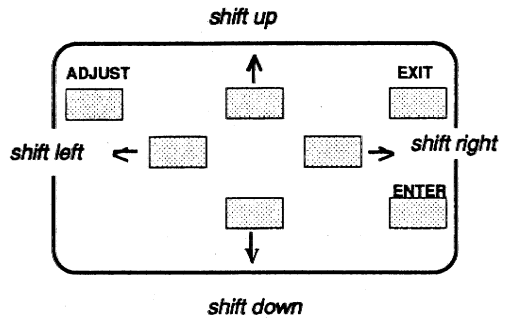
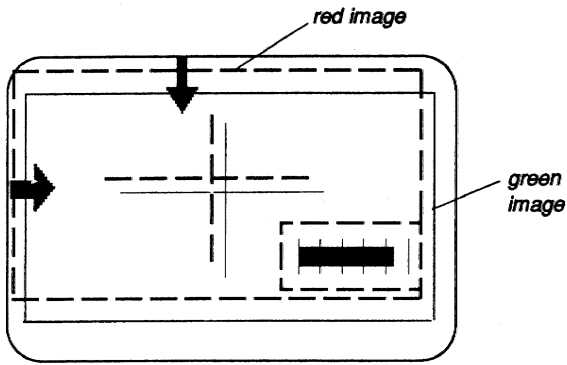

When the red image is correctly positioned, press the **ENTER** key to continue.

<ENTER> continues to blue raster shift
<EXIT> returns to green raster shift

Use the arrow keys to shift the blue image until the center coincides with the center of the green image.

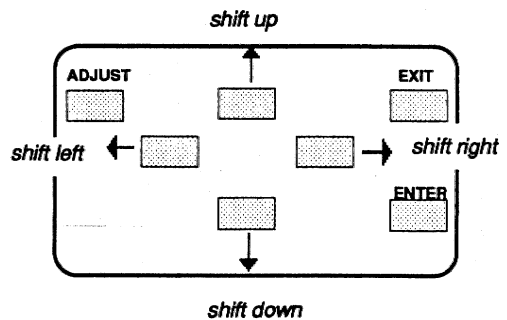
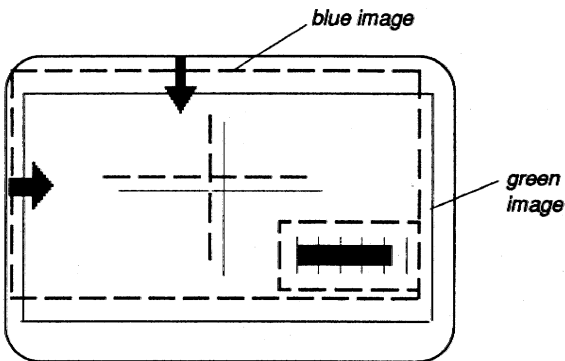

When the blue image is correctly positioned, press the **ENTER** key to continue.

<ENTER> continues to Left-Right adjustments (Menu G3)
<EXIT> returns to red raster shift

GUIDED ADJUSTMENT MODE

Left-Right (East-West) Adjustments

Left-right adjustments affect only the vertical lines of the setup pattern. Only the green image is displayed while making left-right adjustments. The red and blue images will automatically be corrected in the same manner.

Convergence corrections are automatically disabled for the duration of these adjustments.

Press the **ENTER** key to continue.

LEFT-RIGHT
SET V CENTERLINE BOW AND SKEW, SIDE KEYSTONE AND BOW.
AFTER SQUARING THE SIDES OF THE IMAGE USE THE H SIZE CONTROL TO SET THE DESIRED SCREEN WIDTH.
<ENTER> CONTINUE
<EXIT> TO RETURN

menu G3

<ENTER> continues to vertical centerline bow adjustment
 <EXIT> returns to Horizontal and Vertical Shift (Menu G2)
 <ADJUST> returns to operational mode

Vertical Centerline Bow Adjustment

Use the left or right arrow key to adjust the vertical centerline bow of the setup pattern and then press the **ENTER** key to continue.

V CENTERLINE BOW

72

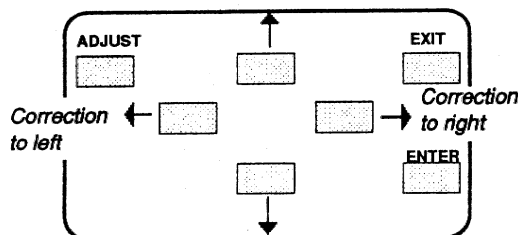
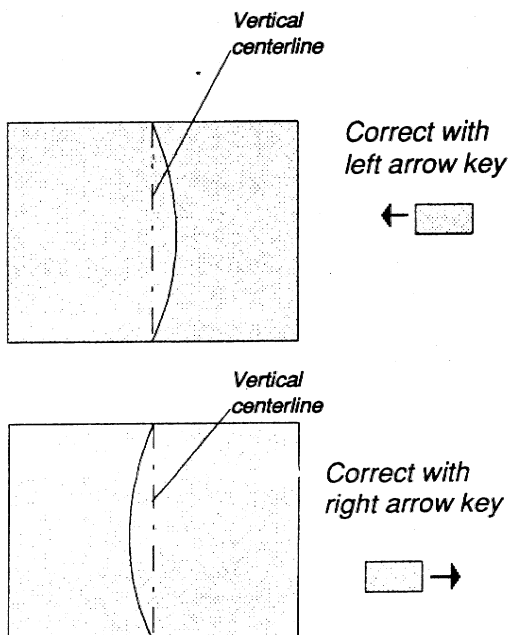

<ENTER> continues to vertical centerline skew adjustment
 <EXIT> returns to Left-Right adjustments (Menu G3)

GUIDED ADJUSTMENT MODE

Vertical Centerline Skew Adjustment

Use the left or right arrow key to adjust the vertical centerline skew of the setup pattern until this line is straight. Misalignment of the outer vertical lines will be corrected with the bow and keystone corrections. Press **ENTER** to continue.

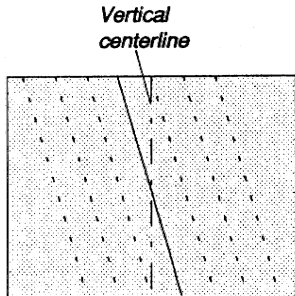
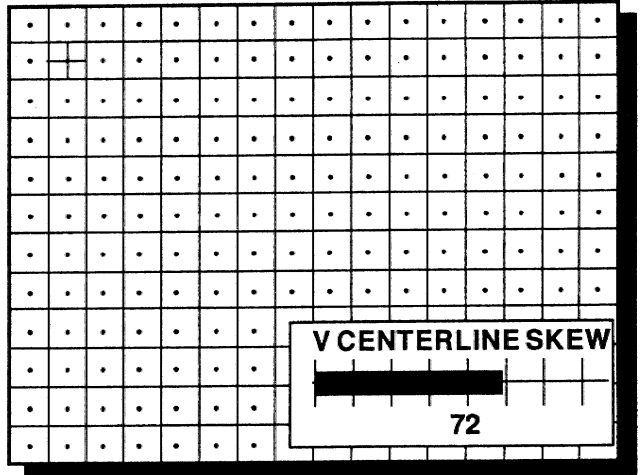

Correct with
right arrow key

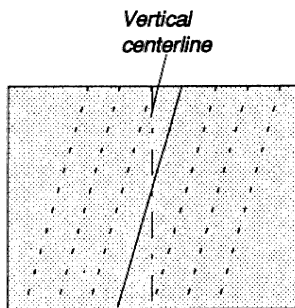

Correct with
left arrow key

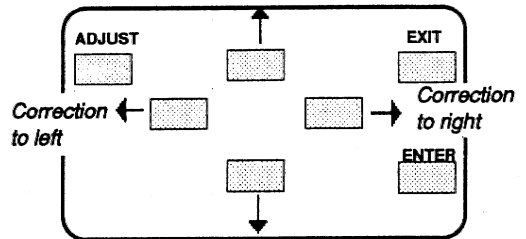

<ENTER> continues to side keystone adjustment
<EXIT> returns to vertical centerline bow adjustment

GUIDED ADJUSTMENT MODE

Side Keystone Adjustment

Use the left or right arrow key to adjust the side keystone (vertical lines) of the setup pattern and press **ENTER** to continue

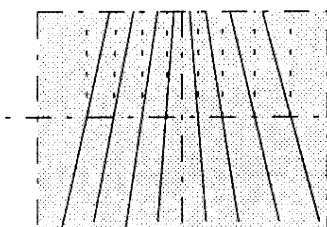
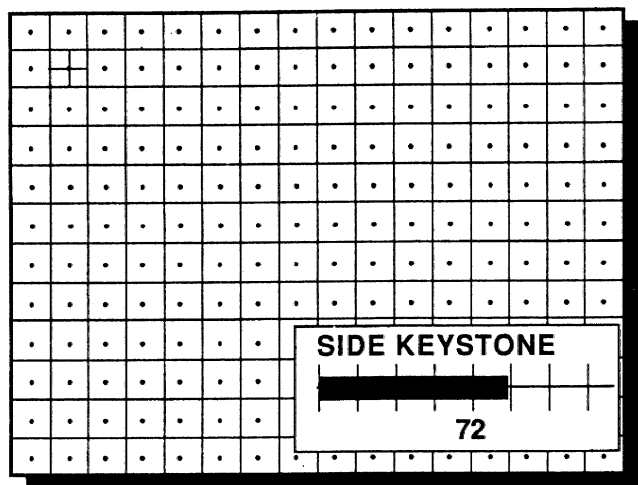

Correct with right arrow key

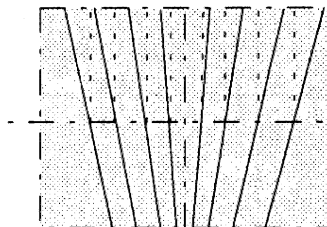
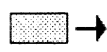

Correct with left arrow key

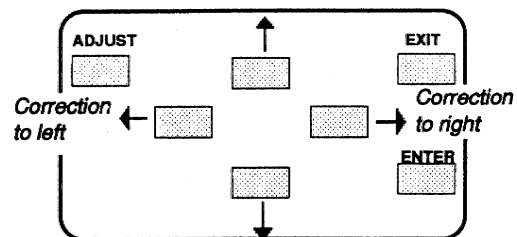
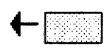

<ENTER> continues to side bow adjustment
<EXIT> returns to vertical centerline skew adjustment

GUIDED ADJUSTMENT MODE

Side Bow Adjustment

Use the left or right arrow key to adjust the side bow of the setup pattern (vertical lines) and press **ENTER** to continue.

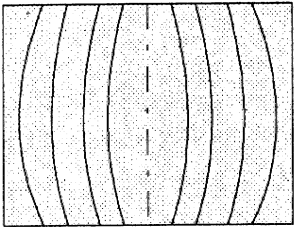
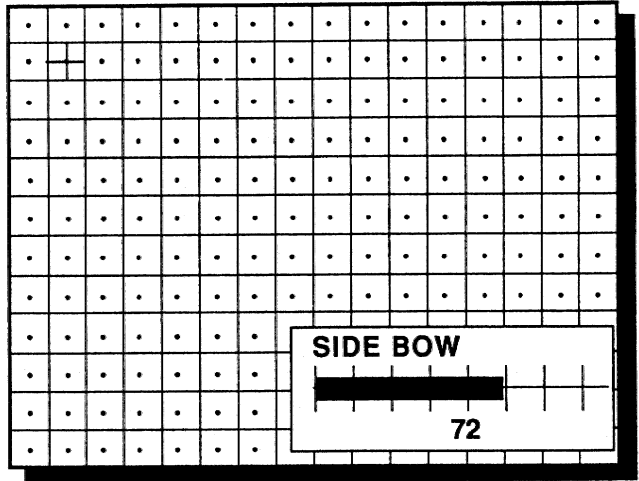

Correct with
right arrow key

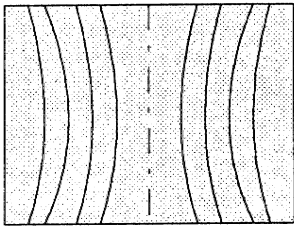

Correct with
left arrow key

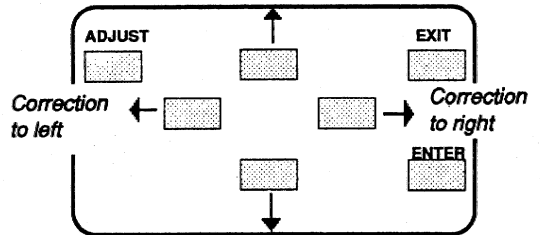

<ENTER> continues to horizontal size adjustment
<EXIT> returns to side keystone adjustment

GUIDED ADJUSTMENT MODE

Horizontal Size Adjustment

Adjust the horizontal size with the left and right arrow key until the exact image width is obtained.

Therefore :

- if the internal # pattern was selected, this pattern remains on the screen.
- if the genlocked pattern was selected, the external source will be displayed.

A bar scale and a number indicator (between 0 and 100) give a visual indication of the horizontal size adjustment.

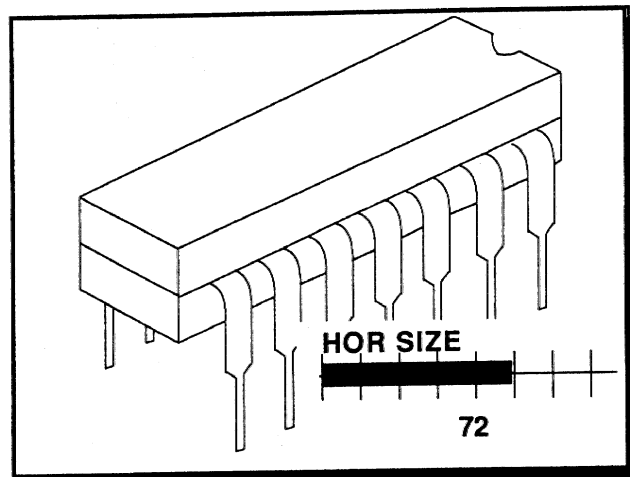

Hint:

In order to avoid loss of resolution in the projected image and to ensure maximum CRT longevity, do not use an excessively small horizontal size setting.

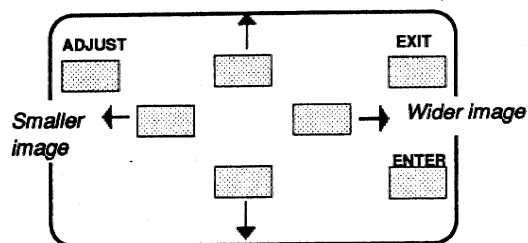
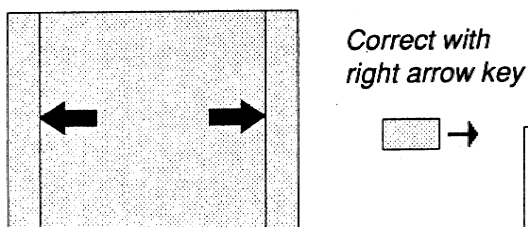
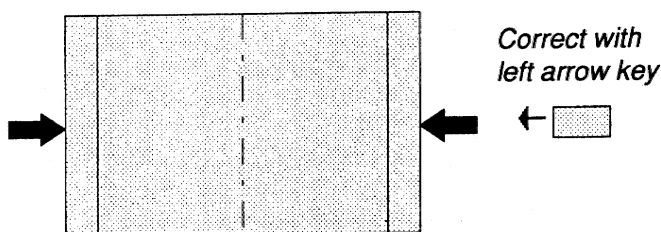

<ENTER> continues to Top-Bottom adjustments (Menu G4)
<EXIT> returns to side bow adjustments

GUIDED ADJUSTMENT MODE

Top-Bottom (North-South) Adjustments

Top-Bottom adjustments affect only the horizontal lines of the setup pattern. These adjustments are performed only on the green image. The red and blue images are automatically corrected in the same manner.

Convergence corrections are automatically disabled for the duration of these adjustments.

Press the **ENTER** key to continue.

TOP-BOTTOM

SET H CENTERLINE
SKEW AND BOW, TOP
KEYSTONE, TOP BOW,
BOTTOM KEYSTONE
AND BOTTOM BOW.

<ENTER> CONTINUE
<EXIT> TO RETURN

menu G4

<ENTER> continues to horizontal centerline skew adjustment
<EXIT> returns to Left-Right adjustments (Menu G3)
<ADJUST> returns to operational mode

GUIDED ADJUSTMENT MODE

Horizontal Centerline Skew Adjustment

Use the up and down arrow key to adjust the horizontal centerline skew of the setup pattern.

A bar scale and a numeric indicator (between 0 and 100) will give a visual indication of the skew correction.

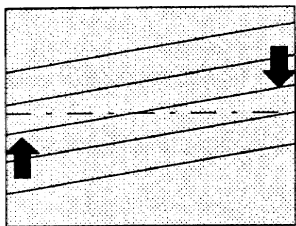
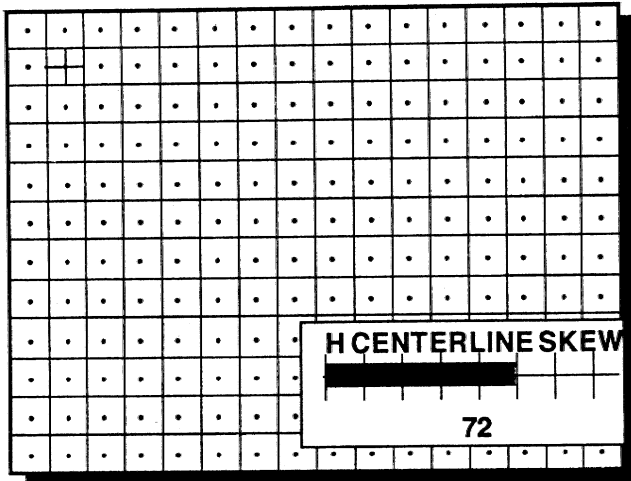

Correct with
down arrow key

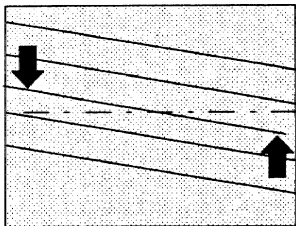

Correct with up
arrow key

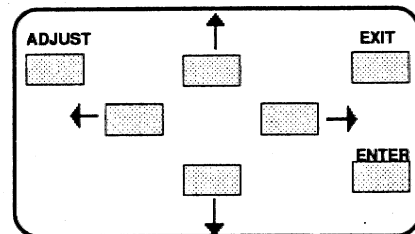

<ENTER> continues to horizontal centerline bow adjustment.

<EXIT> returns to Top-Bottom Adjustments (menu G4).

GUIDED ADJUSTMENT MODE

Horizontal Centerline Bow Adjustment

Use the up and down arrow key to adjust the horizontal centerline bow of the setup pattern.

A bar scale and a numeric indicator (between 0 and 100) will give a visual indication of the bow correction.

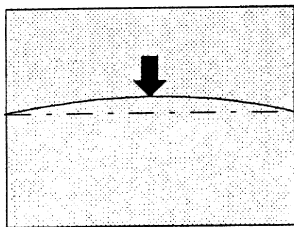
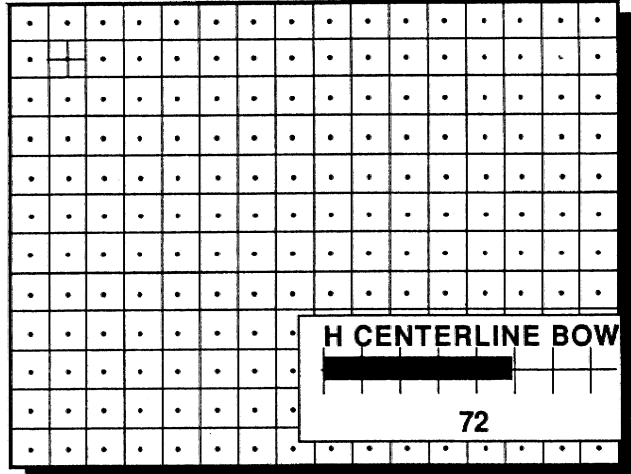

Correct with down arrow key

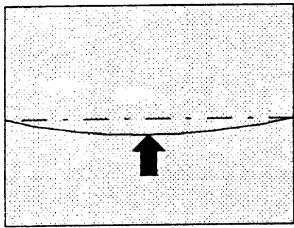

Correct with up arrow key

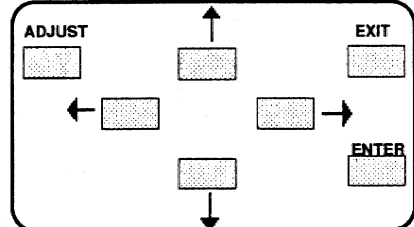

<ENTER> continues to top keystone adjustment
<EXIT> returns to Top-Bottom Adjustments (Menu G4)

GUIDED ADJUSTMENT MODE

Top Keystone Adjustment

Adjust the horizontal lines in the upper part of the picture with the arrow keys until these lines are straight, or almost straight. Press **ENTER** to continue.

A bar scale and a number indicator (between 0 and 100) will give a visual indication of the keystone correction.

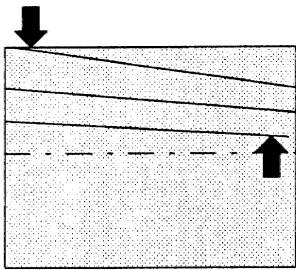
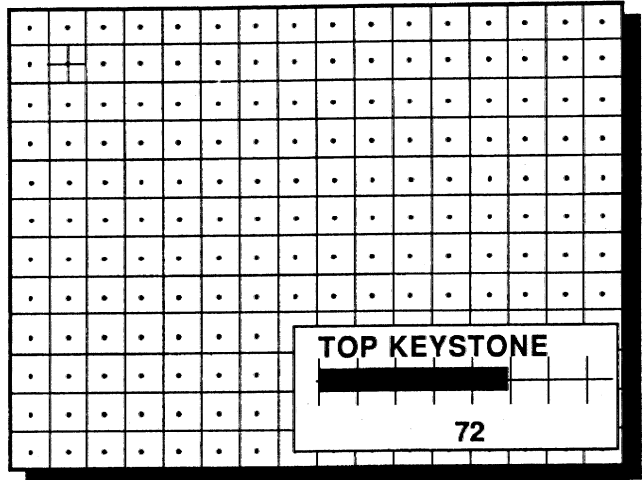

Correct with up arrow key

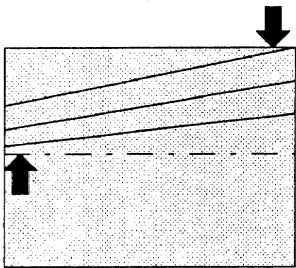

Correct with up arrow key

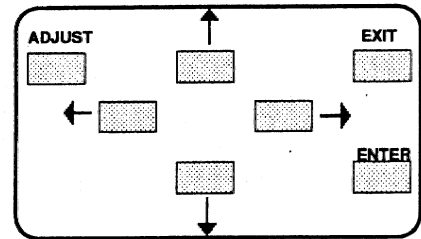

<ENTER> continues to top bow adjustment
<EXIT> returns to horizontal centerline bow adjustment

GUIDED ADJUSTMENT MODE

Top Bow Adjustment

Adjust the bow of the horizontal lines in the upper side of the image with the arrow keys until these lines are straight. A bar scale and a number indicator below indicate the amount of adjustment.

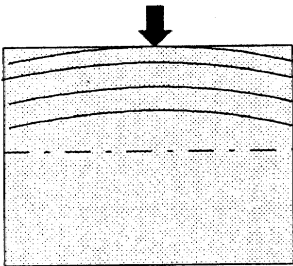
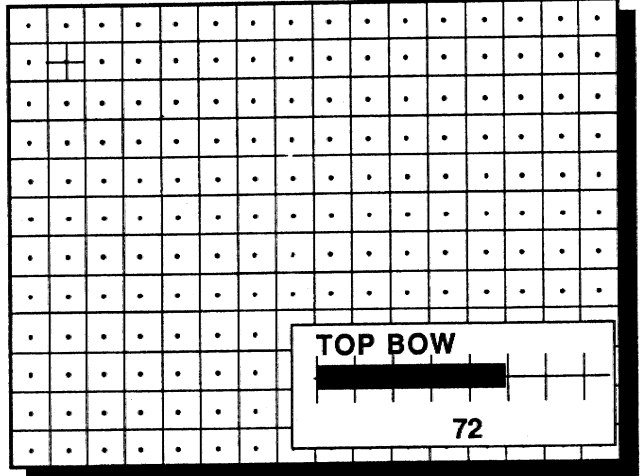

Correct with
down arrow key

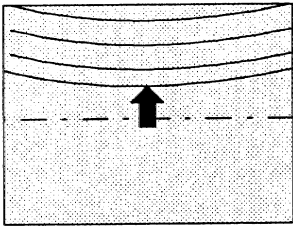

Correct with up
arrow key

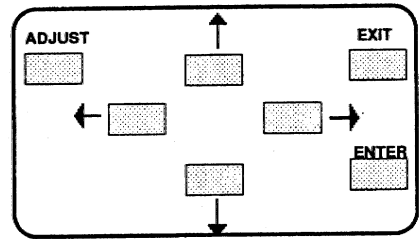

<ENTER> continues to bottom keystone adjustment
<EXIT> returns to top keystone adjustment

GUIDED ADJUSTMENT MODE

Bottom Keystone Adjustment

Adjust the horizontal lines in the lower part of the image with the arrow keys until these lines are straight. A bar scale and a number indicator will give a visual indication of the adjustment.

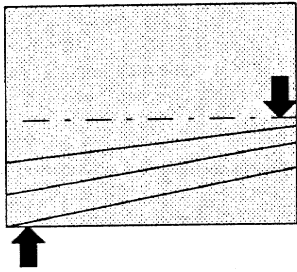
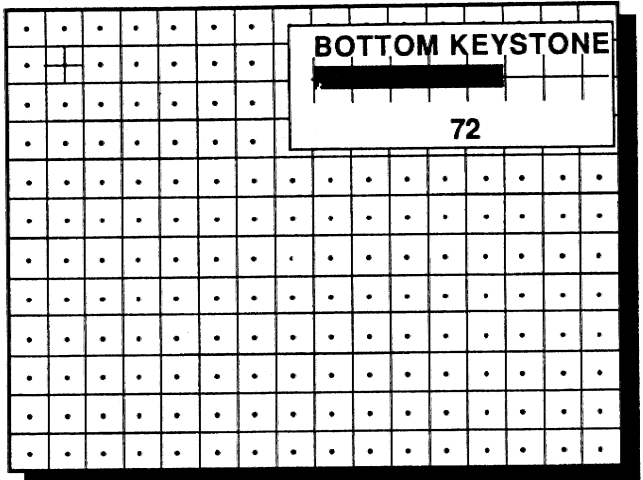

Correct with
down arrow key

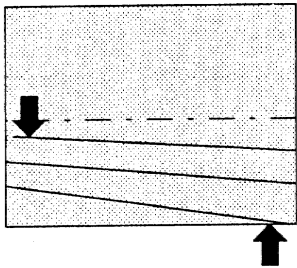

Correct with up
arrow key

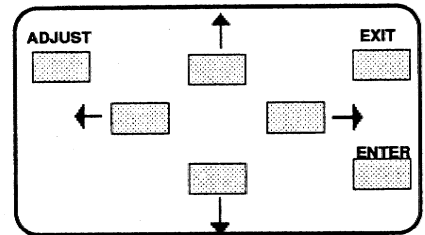

<ENTER> continues to bottom bow adjustment
<EXIT> returns to top bow adjustment

GUIDED ADJUSTMENT MODE

Bottom Bow Adjustment

Use the top and bottom arrow key to adjust the bottom bow in the lower part of the setup pattern. Adjust until the horizontal lines are straight.

A bar scale and a number indicator (between 0 and 100 %) give a visual indication of the adjustment.

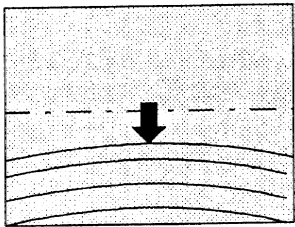
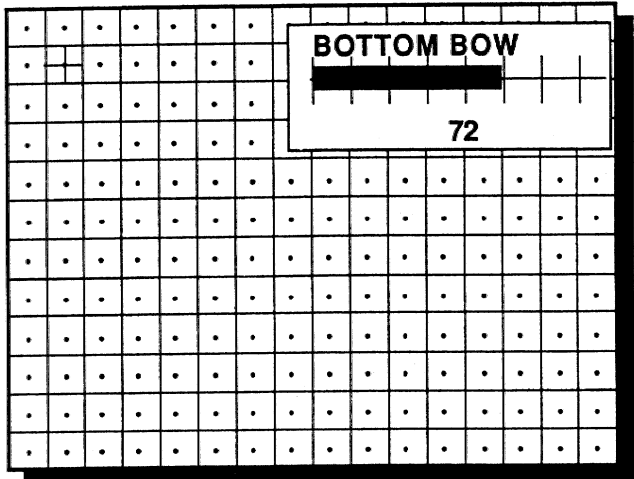

Correct with down arrow key

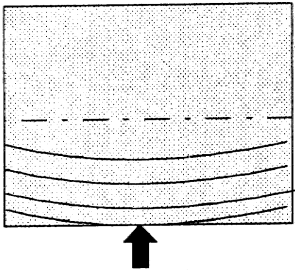

Correct with up arrow key

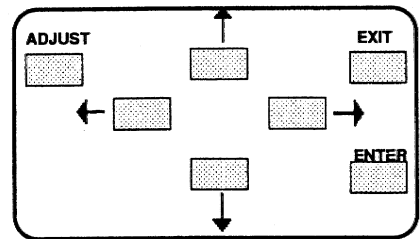

<ENTER> continues to Size-Linearity (Menu G5)
<EXIT> returns to bottom keystone adjustment

GUIDED ADJUSTMENT MODE

Size-linearity Adjustment

Size adjustments affect the height and width of the projected image. The vertical linearity adjustment is used to adjust the horizontal lines of the setup pattern until the spacing between them is even. The horizontal phase adjustment is used to shift the image horizontally across the raster.

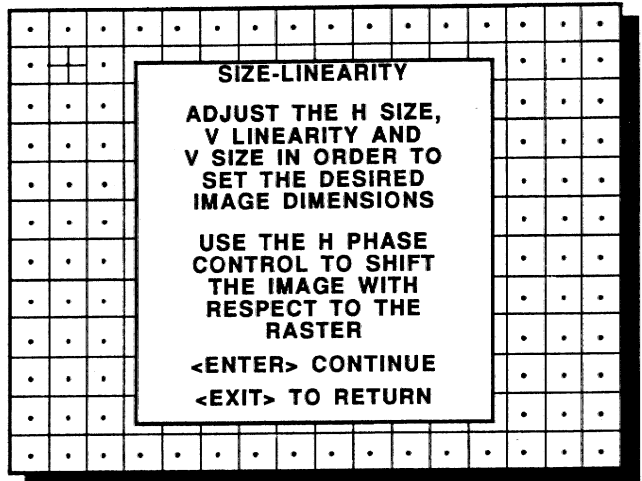

menu G5

<ENTER> continues to horizontal size adjustment
<EXIT> returns to Top-Bottom adjustments (Menu G4)
<ADJUST> returns to operational mode

GUIDED ADJUSTMENT MODE

Horizontal Size Adjustment

Adjust the horizontal size with the left and right arrow key until the exact image width is obtained.

Therefore :

- if the internal # pattern was selected, this pattern remains on the screen.
- if the genlocked pattern was selected, the external source will be displayed.

Hint :

In order to avoid loss of resolution in the projected image and to ensure maximum CRT longevity, do not use an excessively small horizontal size setting.

A bar scale and a number indicator (between 0 and 100) give a visual indication of the horizontal size adjustment.

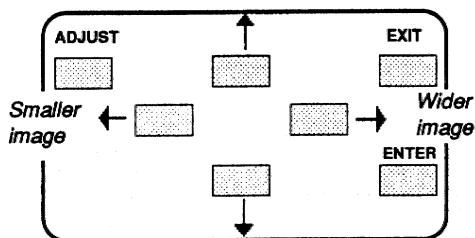
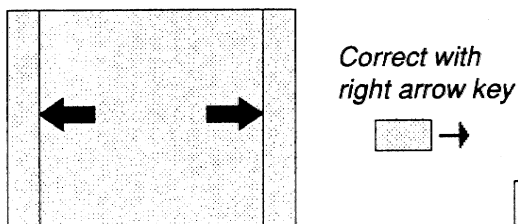
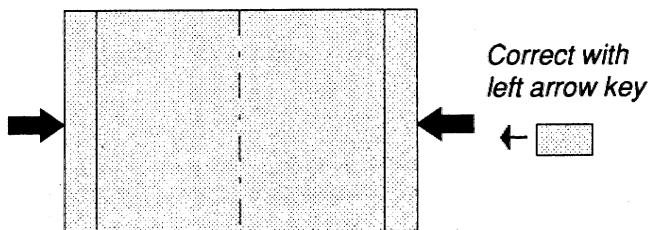
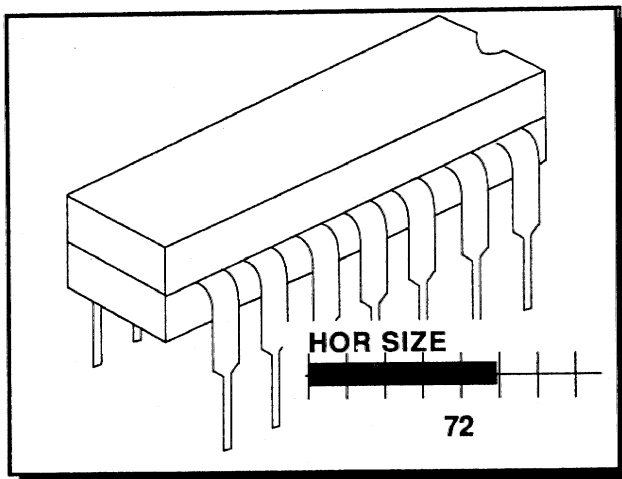

<ENTER> continues to vertical linearity adjustment
<EXIT> returns to Size-Linearity (Menu G5)

GUIDED ADJUSTMENT MODE

Vertical Linearity Adjustment

Adjust the vertical linearity with the arrow keys until the distance between the horizontal lines of the set up pattern are equal.

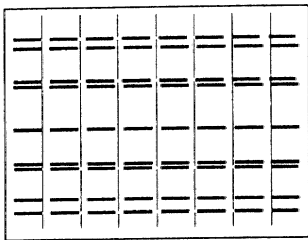
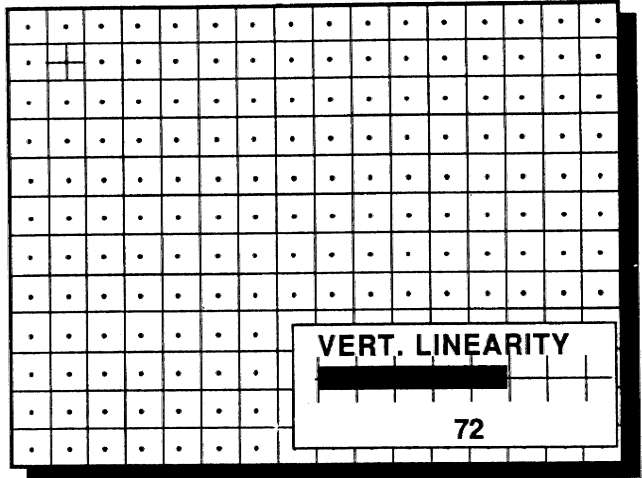

Correct with up arrow key

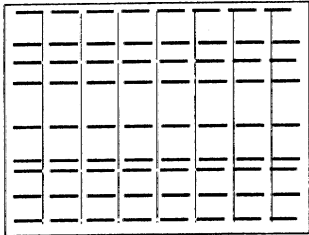

Correct with down arrow key

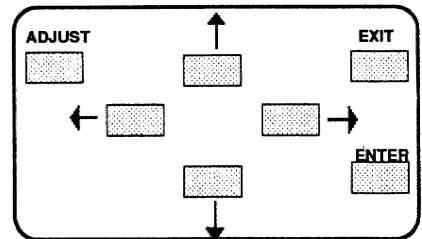

<ENTER> continues to vertical size adjustment
<EXIT> returns to horizontal size adjustment

GUIDED ADJUSTMENT MODE

Vertical Size Adjustment

Adjust the vertical size with the up or down arrow key until the exact image height is obtained.

Therefore :

- if the internal # pattern was selected, this pattern remains on the screen.
- if the genlocked pattern was selected, the external source will be displayed.

Hint :

In order to avoid loss of resolution in the projected image and to ensure maximum CRT longevity, do not use an excessively small vertical size setting.

A bar scale and a number indicator (between 0 and 100) give a visual indication of the vertical size adjustment.

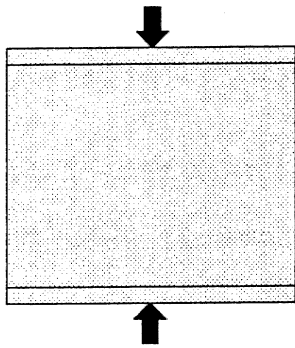
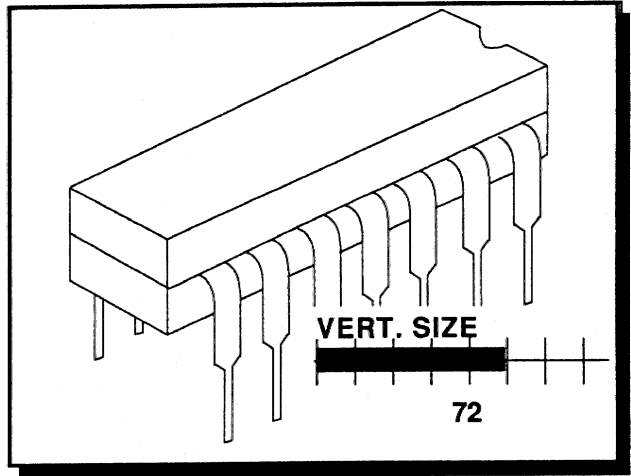

smaller image

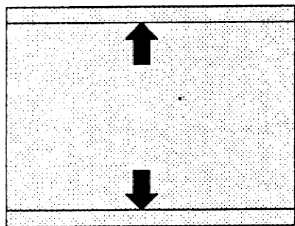

higher image

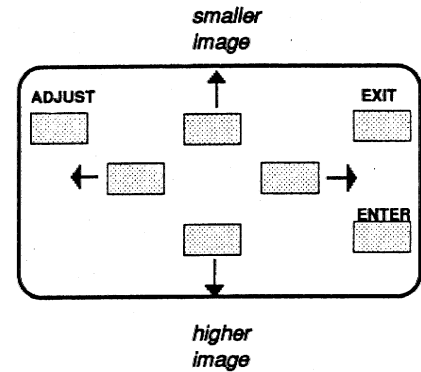

<ENTER> continues to horizontal phase adjustment
<EXIT> returns to vertical linearity adjustment

Horizontal Phase Adjustment

Note : No horizontal phase adjustment available on the internal # pattern.

For external sources :
Adjust the horizontal phase with the arrow keys until full characters are displayed on the left and right side of the picture.

Therefore :
- if the genlocked pattern was selected, the external source will be displayed.

In order to optimize the image quality, the image should be shifted to the 'end of scan' side of the raster. For front screen applications, the 'end of scan' side of the raster is on the right hand side of the screen. For rear screen applications, it is on the left hand side.

Decrease the contrast and increase the brightness level until the raster becomes visible on the screen. Use the left or right arrow keys to shift the setup pattern to the proper position on the raster.

Restore the brightness and contrast to normal levels after performing the horizontal phase adjustment.
A bar scale and a number indicator (between 0 and 100) on the screen give a visual indication of the horizontal phase adjustment.

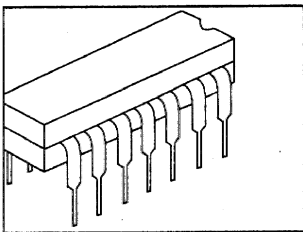
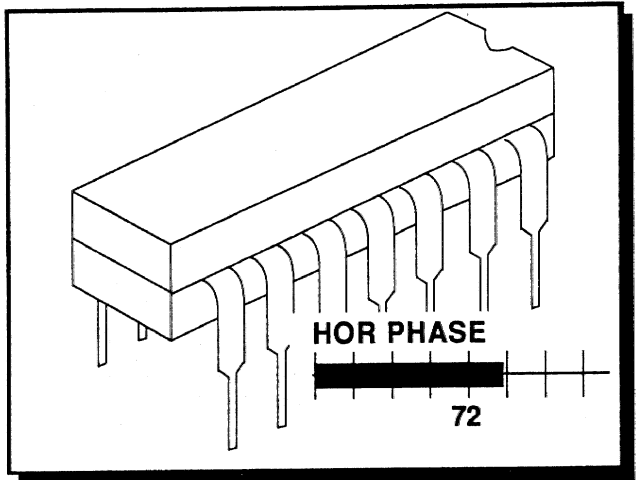

Correct with
right arrow key

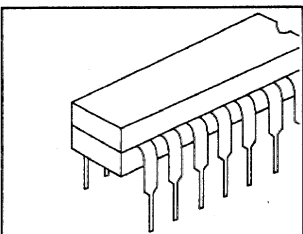

Correct with
left arrow key

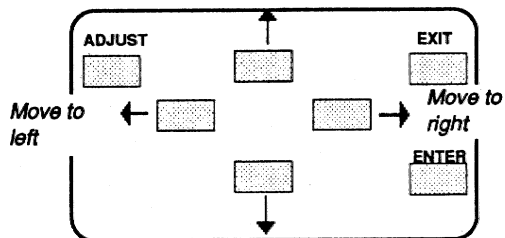

<ENTER> continues to Convergence (Menu G6)
<EXIT> returns to vertical size adjustment

GUIDED ADJUSTMENT MODE

Convergence Adjustment

Convergence adjustments affect both the horizontal and vertical lines of the setup pattern. These adjustments are performed on the red image while superimposed on the green image and then on the blue image while superimposed on the green image.

The screen area is divided into 13 areas. Within each area it is possible to move the horizontal and vertical lines of the red and blue picture until they coincide with the green lines.

Use the arrow keys to make horizontal and vertical convergence adjustments in the area indicated by the box. Pressing **ENTER** will move the box to the next area of the setup pattern to be converged. Pressing **EXIT** will move the box back to the last area.

The 'guided adjustment' program will start with the convergence adjustment of the red picture on the green and continues with the blue image on the green image.

Attention : when green convergence adjustments are available. The control software starts with these green corrections (the menu will indicate it also). Adjust until the vertical and horizontal lines are straight.

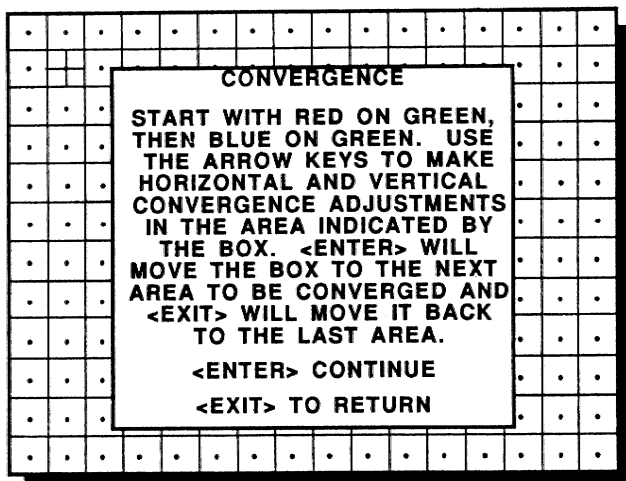

menu G6

<ENTER> continues to convergence adjustment
 <EXIT> returns to Size-Linearity adjustments (Menu G5).
 <ADJUST> returns to operational mode

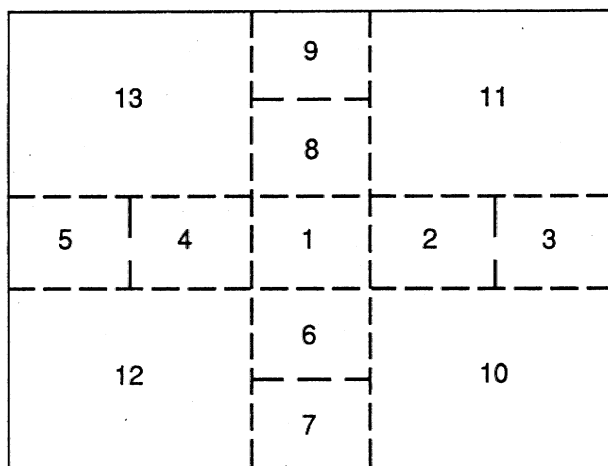

GUIDED ADJUSTMENT MODE

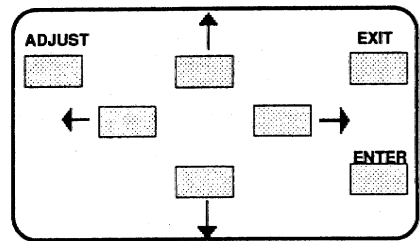
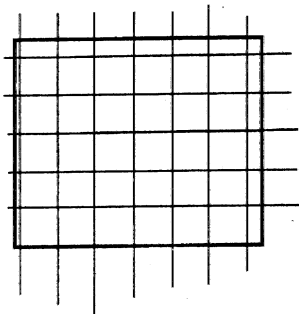
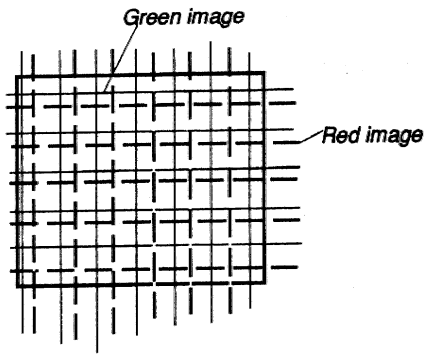
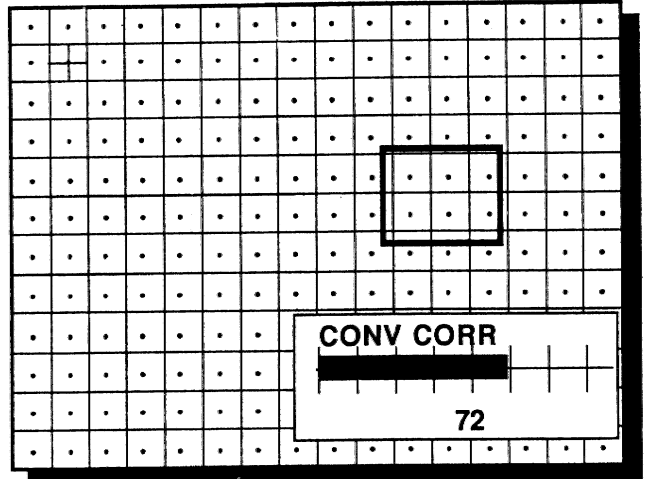

<ENTER> selects a new box and at the end it continues with the Blanking Adjustment, Menu G7.
<EXIT> returns to the last area.

GUIDED ADJUSTMENT MODE

Blanking Adjustment

Blanking adjustments affect only the edges of the projected image and are used to frame the projected image on to the screen.

The following blanking corrections are possible :

- top blanking
- bottom blanking
- left blanking
- right blanking

Therefore :

- if the internal # pattern was selected, this pattern remains on the screen.
- if the genlocked pattern was selected, the external source will be displayed.

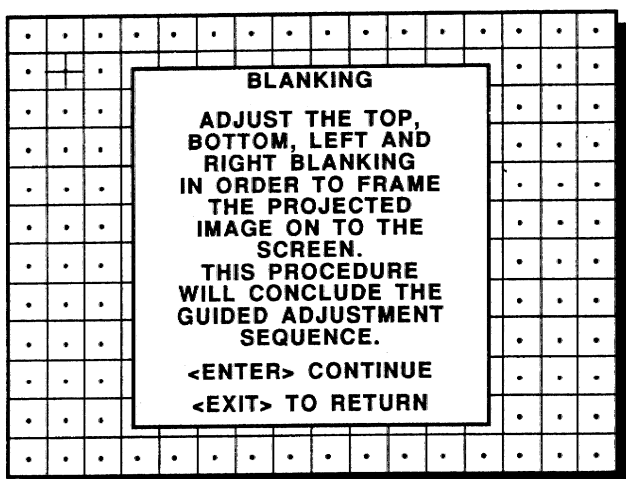

menu G7

<ENTER> continues to top blanking adjustment.
<EXIT> returns to convergence (Menu G6)
<ADJUST> returns to operational mode

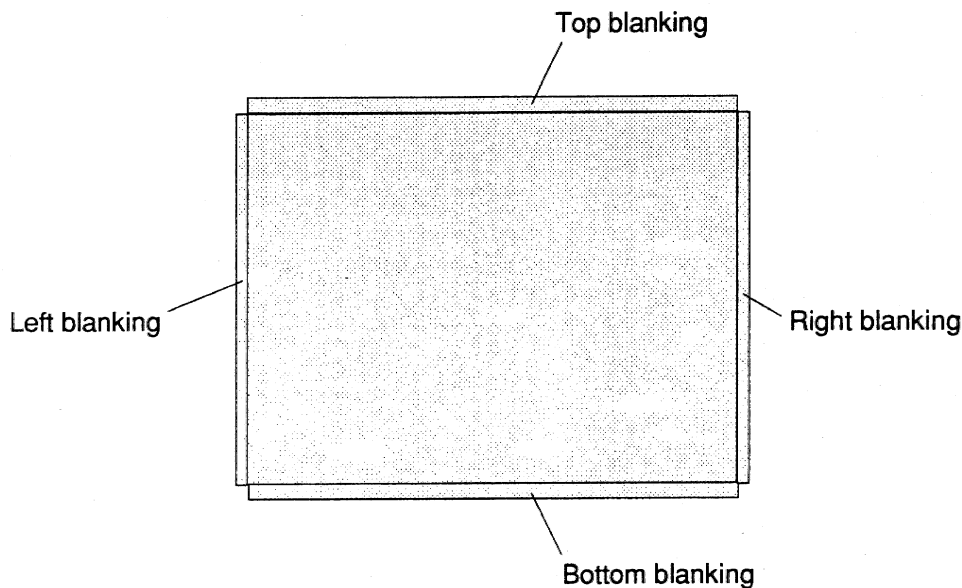

GUIDED ADJUSTMENT MODE

Top blanking adjustment

Use the up or down key to adjust the top blanking of the setup pattern. Press **ENTER** to continue.

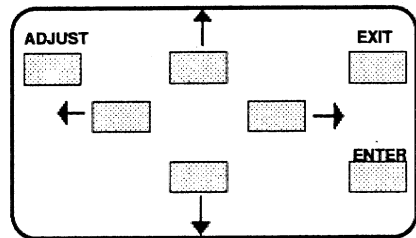
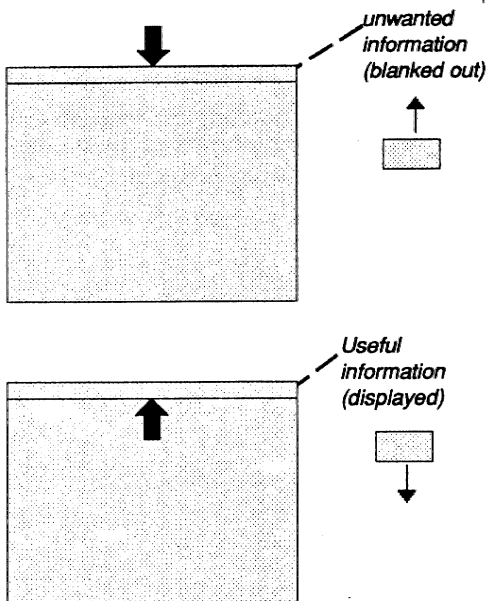
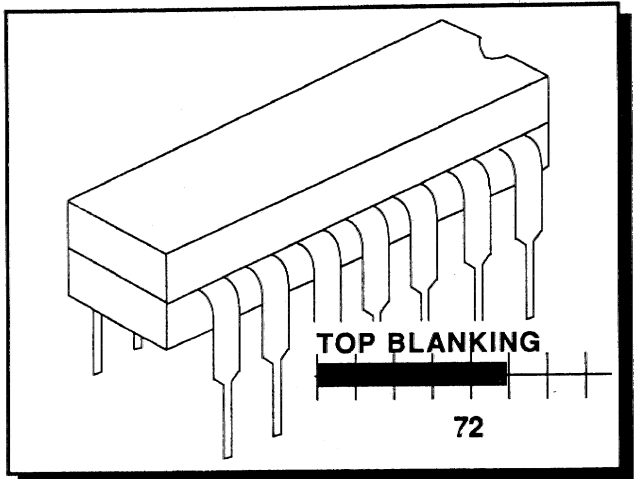

<ENTER> continues to bottom blanking adjustment.
<EXIT> returns to blanking adjustments (Menu G7).

GUIDED ADJUSTMENT MODE

Bottom blanking adjustment

Use the up or down key to adjust the bottom blanking of the setup pattern.

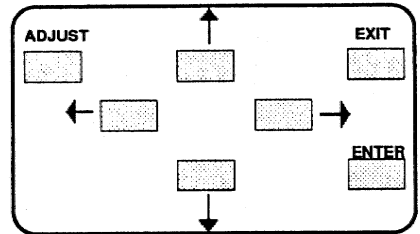
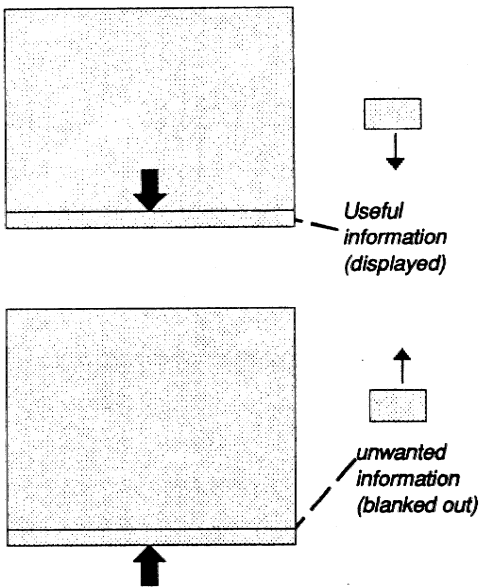
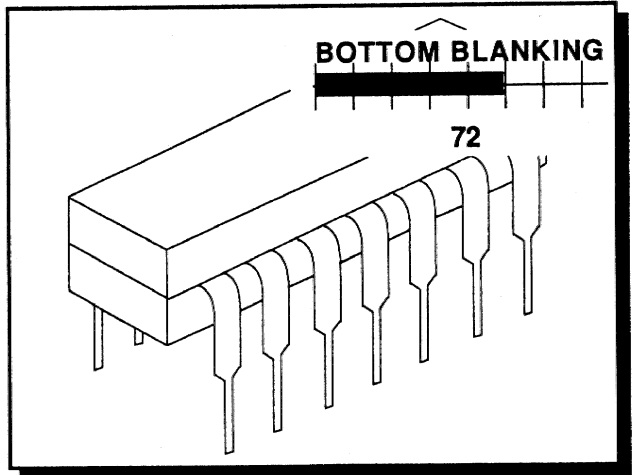

<ENTER> continues to left blanking adjustment.
<EXIT> returns to top blanking adjustments.

GUIDED ADJUSTMENT MODE

Left blanking adjustment

Use the left or right arrow key to adjust the left blanking of the setup pattern.

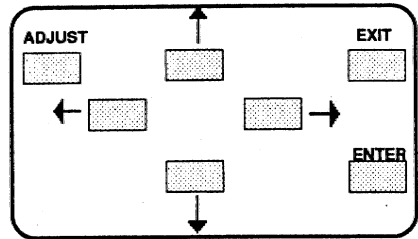
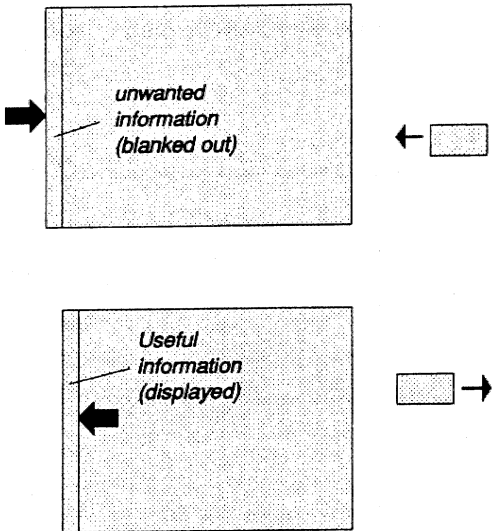
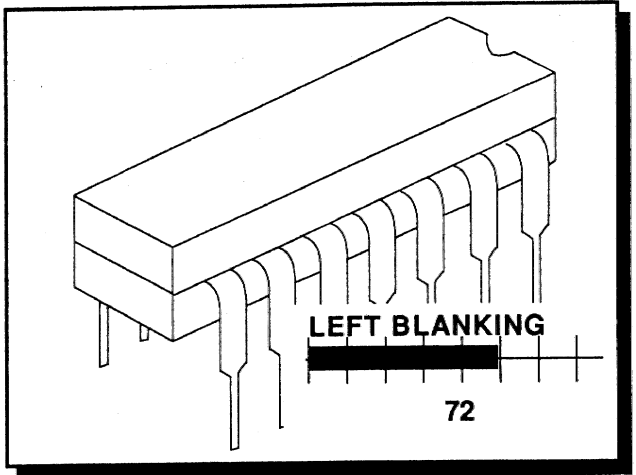

<ENTER> continues to right blanking adjustment.
<EXIT> returns to bottom blanking adjustments.

GUIDED ADJUSTMENT MODE

Right blanking adjustment

Use the left or right arrow key to adjust the right blanking of the setup pattern.

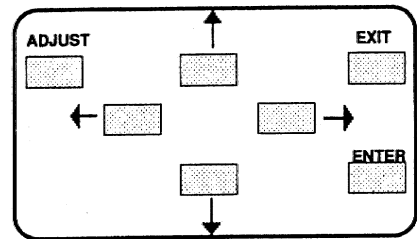
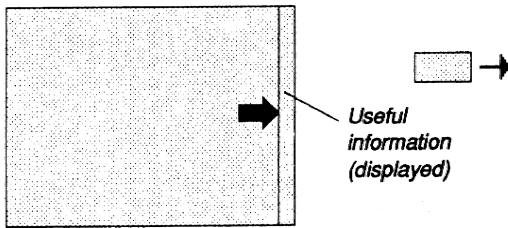
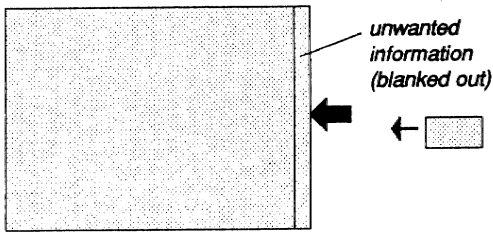
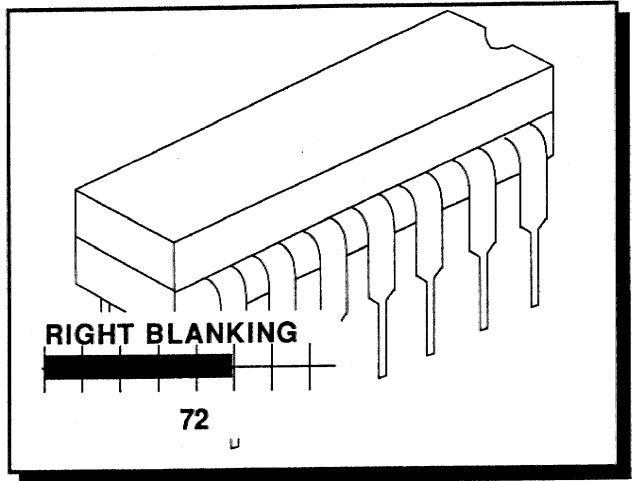

<ENTER> concludes the Guided Adjustment Sequence.
<EXIT> returns to left blanking adjustments.

GUIDED ADJUSTMENT MODE

RANDOM ACCESS ADJUSTMENT MODE

STARTING UP THE RANDOM ACCESS ADJUSTMENT MODE

OVERVIEW FLOW CHARTS

SYNC FAST/SLOW

ENHANCED BLUE ON/OFF

COLOR SELECT

COLOR BALANCE

WHITE BALANCE

BLACK BALANCE

GEOMETRY ADJUSTMENT

HORIZONTAL PHASE

RASTER SHIFT

LEFT-RIGHT ADJUSTMENTS

VERTICAL CENTERLINE BOW

VERTICAL CENTERLINE SKEW

SIDE KEYSTONE

SIDE BOW

TOP-BOTTOM ADJUSTMENTS

HORIZONTAL CENTERLINE BOW

HORIZONTAL CENTERLINE SKEW

TOP KEYSTONE

TOP BOW

BOTTOM KEYSTONE

BOTTOM BOW

HORIZONTAL SIZE

VERTICAL LINEARITY

VERTICAL SIZE

BLANKING

CONVERGENCE CORRECTIONS

RANDOM ACCESS ADJUSTMENT MODE

Starting up the random access adjustment mode.

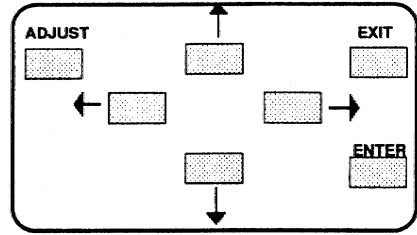

Use the arrow keys on the RCU800 to highlight "RANDOM ACCESS" and then press **ENTER**.

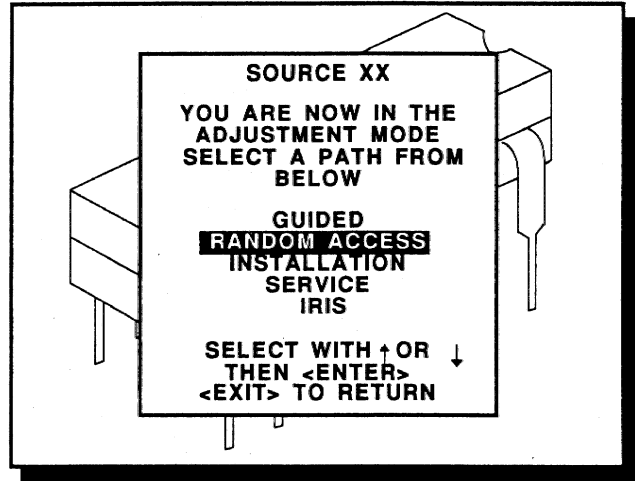

menu S1

<ENTER> continues to Setup Pattern Selection (Menu S2 or S3)
<EXIT> returns to operational mode

RANDOM ACCESS ADJUSTMENT MODE

Overview flow chart 'Random Access Adjustment' mode.

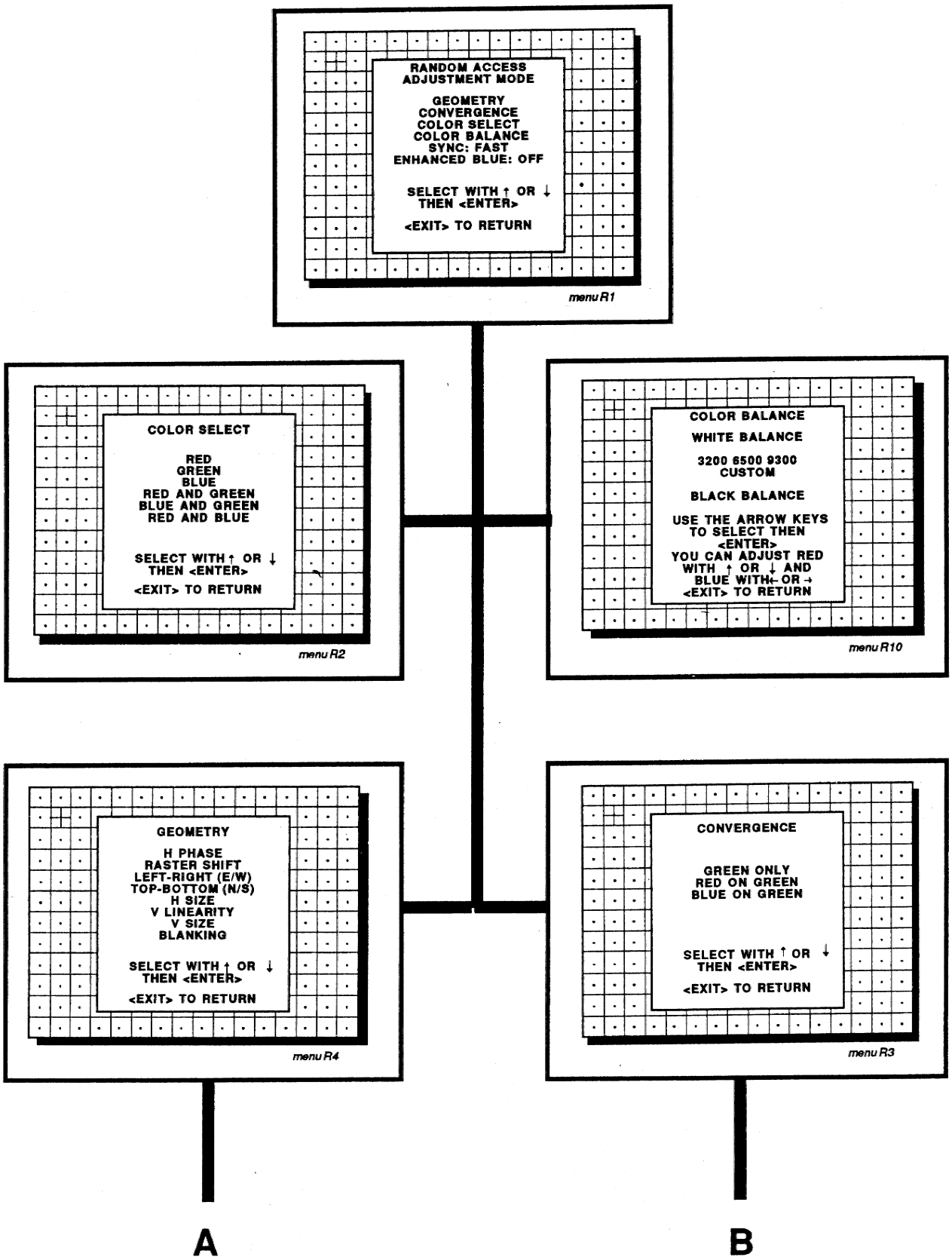

RANDOM ACCESS ADJUSTMENT MODE

A

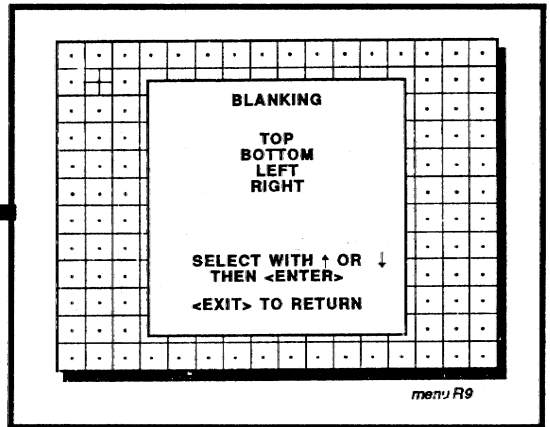
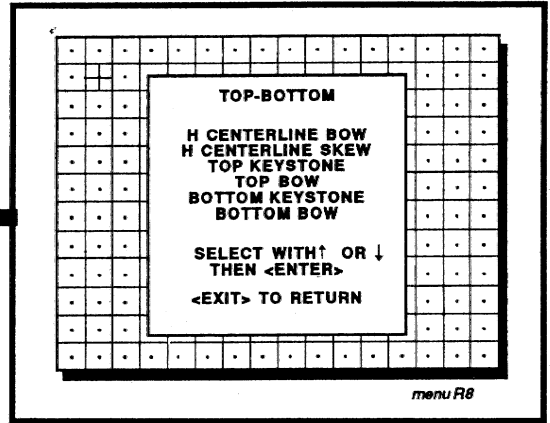
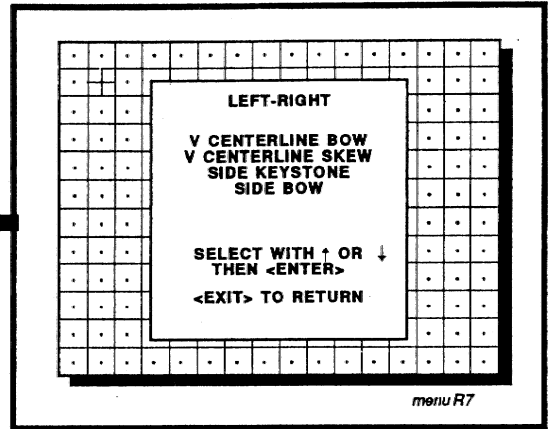
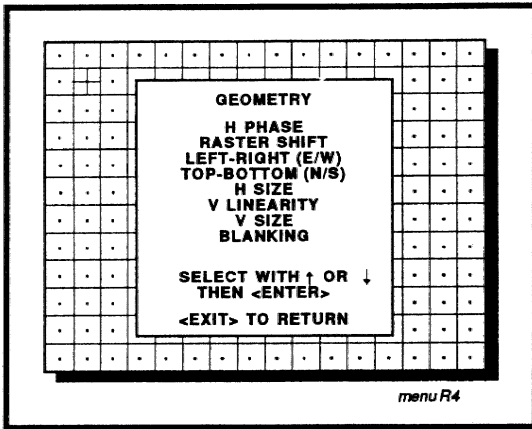

B

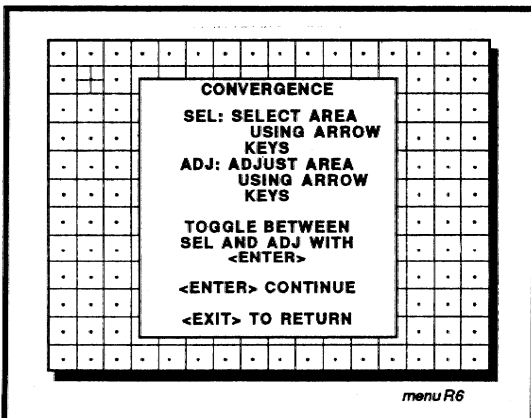

RANDOM ACCESS ADJUSTMENT MODE

Selecting Setup Pattern

If an external source is connected to the projector, Menu S2 will be displayed. Use the arrow keys to highlight the desired setup pattern and then press **ENTER**.

Genlocked pattern : internally generated cross hatch pattern, locked on the external source.

Internal # pattern : internally generated cross hatch pattern and locked on internal generated sync signals. (No external source necessary)

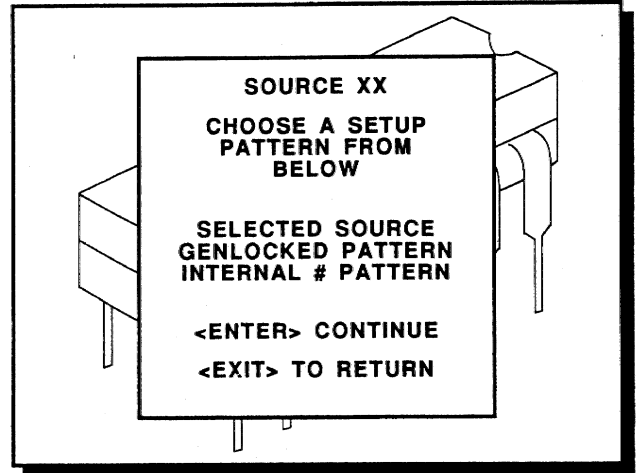

menu S2

<ENTER> continues to Random Access Adjustment Mode (Menu R1) or Internal # Pattern Selection (Menu S4)
<EXIT> returns to Path Selection (Menu S1)
<ADJUST> returns to operational mode

If no external source is connected to the projector, Menu S3 will be displayed. Press **ENTER** to select the internally generated cross hatch pattern.

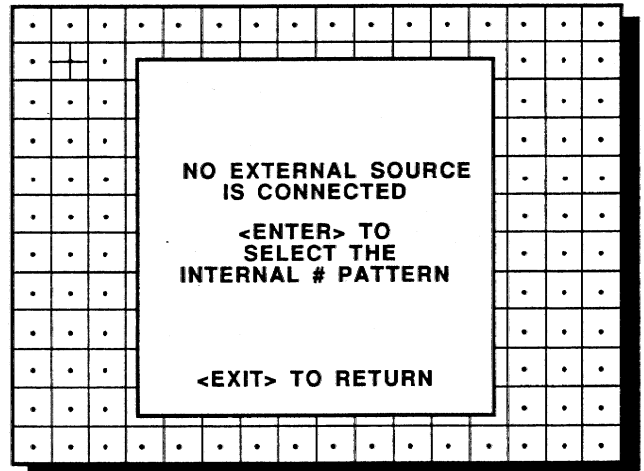

menu S3

<ENTER> continues to Internal # Pattern Selection (Menu S4)
<EXIT> returns to Path Selection (Menu S1)

The menus in this manual are created for an external source, connected to one of the inputs, and the 'Genlock pattern' is selected.

RANDOM ACCESS ADJUSTMENT MODE

Internal Cross Hatch Pattern

Menu S4 will be displayed if the internal cross hatch pattern has been selected. The table below lists the 8 factory preset frequencies available.

Use the arrow keys to highlight the desired cross hatch frequency and then press **ENTER**.

STD: Fh = 15.6 KHz Fv = 50 Hz
 CGA: Fh = 15.7 KHz Fv = 60 Hz
 HD1: Fh = 31.2 KHz Fv = 50 Hz
 HD2: Fh = 31.5 KHz Fv = 60 Hz
 PR1: Fh = 33.7 KHz Fv = 60 Hz
 PR2: Fh = 35.0 KHz Fv = 50 Hz
 PR3: Fh = 15.6 KHz Fv = 70 Hz
 PR4: Fh = 31.2 KHz Fv = 100 Hz

It is possible to store user defined cross hatch frequencies in PR1 - PR4. Follow the steps below to program a custom cross hatch frequency.

1. Highlight the desired storage location (PR1 - PR4) on menu S4.
2. Press **TEXT** to reprogram.
3. Use the arrow keys to select the digits to be changed.
4. Reprogram the desired horizontal frequency as XX.X KHz and the vertical frequency as XXX Hz using the numeric keys.
5. Press **ENTER** to confirm.

Example: Desired cross hatch frequency:

Fh = 34.8 KHz
 Fv = 60 Hz

Use arrow keys to highlight the desired storage location (PR1 - PR4) and press **TEXT**. The reprogram menu appears on the screen. Use the arrow keys to go to the first digits of the horizontal frequency and

Press 3 4 8 0 6 0 **<ENTER>**

Note : always enter 6 digits. Use if necessary a 0 before the first significant digit of the vertical frequency.

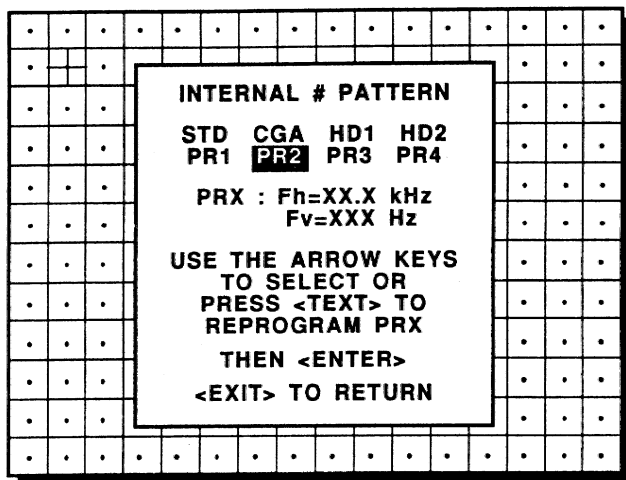

menu S4

<ENTER> continues to Random Access adjustment mode (Menu R1)
<EXIT> returns to Setup Pattern Selection (Menu S2 or S3)
<TEXT> gives the reprogram menu (Menu S4 bis)

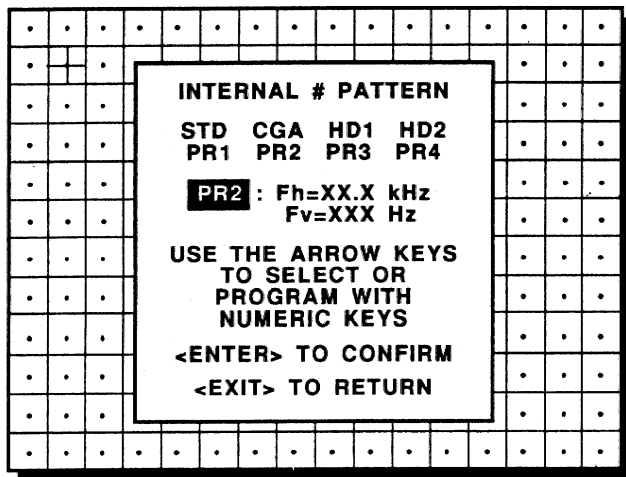

menu S4

<ENTER> confirms your entry and continues to Random Access Adjustment Mode (Menu R1)
<EXIT> returns to Setup Pattern Selection (Menu S2 or S3)

RANDOM ACCESS ADJUSTMENT MODE

Random access adjustment mode selection menu.

Menu R1 is the main menu for the Random Access adjustment mode. Through this menu, the following adjustments and features are accessible :

- Geometry
- Convergence
- Color select
- Color balance
- Sync : slow/fast
- Enhanced blue : on/off

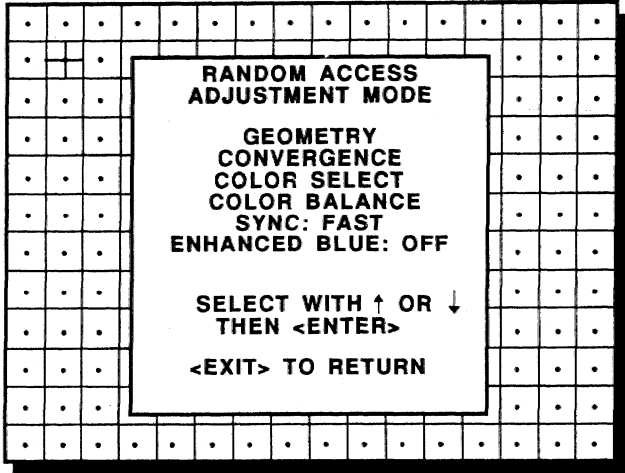

menu R1

Sync Fast/Slow Adjustment

Highlight *SYNC* with the arrow keys and press **ENTER** to toggle between *FAST* and *SLOW*.

Note: SYNC is normally used in the SLOW position. The FAST position is used to compensate for unsteady sync pulses from older video playback equipment.

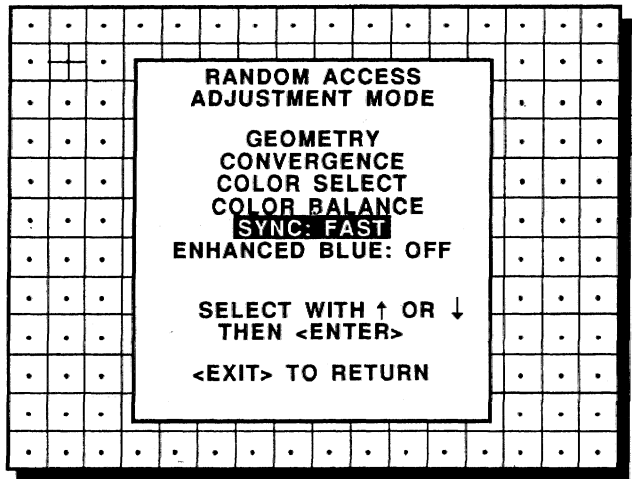

menu R1

<ENTER> will toggle Sync between FAST and SLOW
<EXIT> will return to Internal Crosshatch Selection (Menu S4) or Setup Pattern Selection (Menu S2)

RANDOM ACCESS ADJUSTMENT MODE

Enhanced Blue On/Off Adjustment

Highlight *ENHANCED BLUE* with the arrow keys and press **ENTER** to toggle between *ON* and *OFF*. (only available when RGB signals are connected)

When 'Enhanced Blue' is ON, the blue color will be displayed as cyanic.

Note: Enhanced blue is only used when an RGBS or RGsB analog signal from a computer is being displayed. Enhanced blue is not recommended for non computer generated images.

For displaying graphics, this 'Enhanced Blue' function could falsify the color reproduction. In this case, put Enhanced Blue OFF.

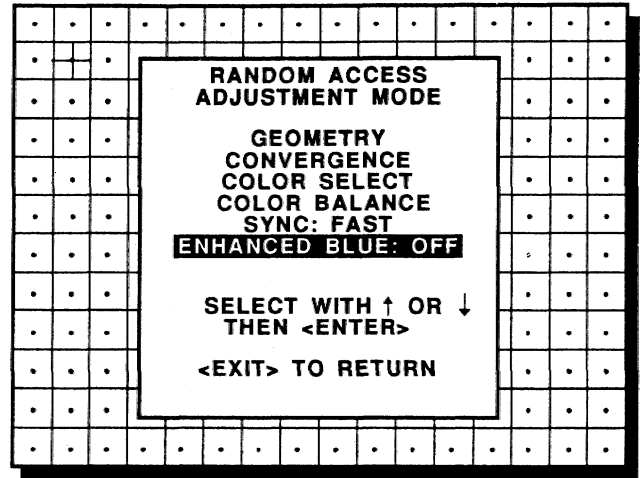

menu R1

<ENTER> will toggle Enhanced Blue between ON and OFF

<EXIT> will return to Internal Crosshatch Selection (Menu S4) or Setup Pattern Selection (Menu S2)

<ADJUST> returns to operational mode

Color Select

Highlight *COLOR SELECT* with the arrow keys and press **ENTER** to display menu R2.

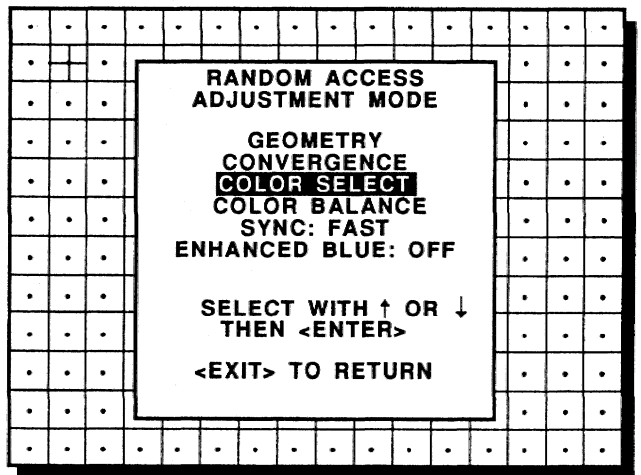

menu R1

<ENTER> continues to the color select menu, menu R2

<EXIT> will return to Internal Crosshatch Selection (Menu S4) or Setup Pattern Selection (Menu S2)

<ADJUST> returns to operational mode

RANDOM ACCESS ADJUSTMENT MODE

Random access adjustment mode selection menu.

Menu R1 is the main menu for the Random Access adjustment mode. Through this menu, the following adjustments and features are accessible :

- Geometry
- Convergence
- Color select
- Color balance
- Sync : slow/fast
- Enhanced blue : on/off

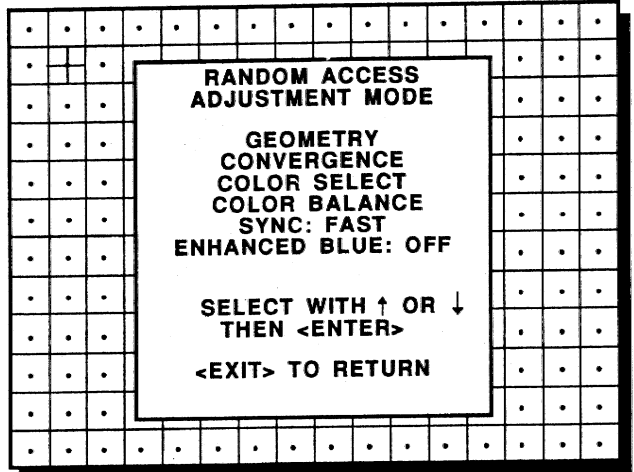

menu R1

Sync Fast/Slow Adjustment

Highlight *SYNC* with the arrow keys and press **ENTER** to toggle between *FAST* and *SLOW*.

Note: SYNC is normally used in the SLOW position. The FAST position is used to compensate for unsteady sync pulses from older video playback equipment.

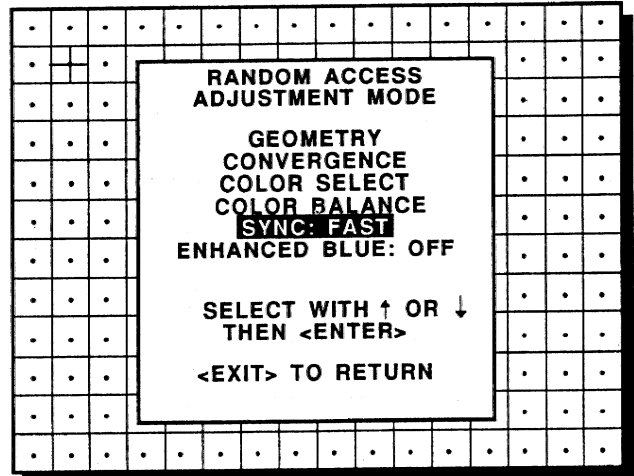

menu R1

<ENTER> will toggle Sync between FAST and SLOW
<EXIT> will return to Internal Crosshatch Selection (Menu S4) or Setup Pattern Selection (Menu S2)

RANDOM ACCESS ADJUSTMENT MODE

Enhanced Blue On/Off Adjustment

Highlight *ENHANCED BLUE* with the arrow keys and press **ENTER** to toggle between *ON* and *OFF*. (only available when RGB signals are connected)

When 'Enhanced Blue' is ON, the blue color will be displayed as cyanic.

Note: Enhanced blue is only used when an RGBS or RGSB analog signal from a computer is being displayed. Enhanced blue is not recommended for non computer generated images.

For displaying graphics, this 'Enhanced Blue' function could falsify the color reproduction. In this case, put Enhanced Blue OFF.

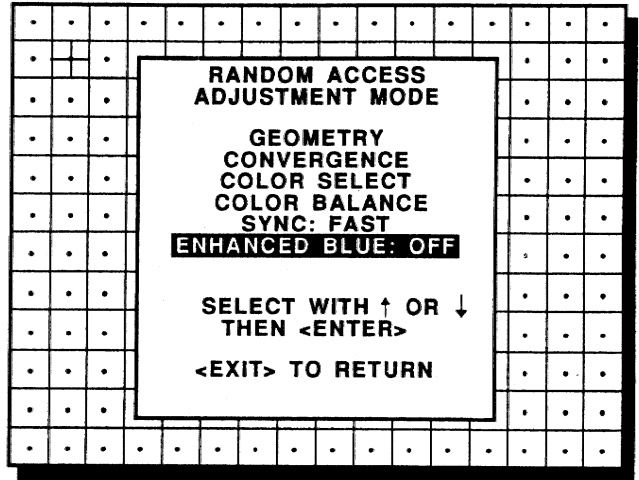

menu R1

<ENTER> will toggle Enhanced Blue between ON and OFF
<EXIT> will return to Internal Crosshatch Selection (Menu S4) or Setup Pattern Selection (Menu S2)
<ADJUST> returns to operational mode

Color Select

Highlight *COLOR SELECT* with the arrow keys and press **ENTER** to display menu R2.

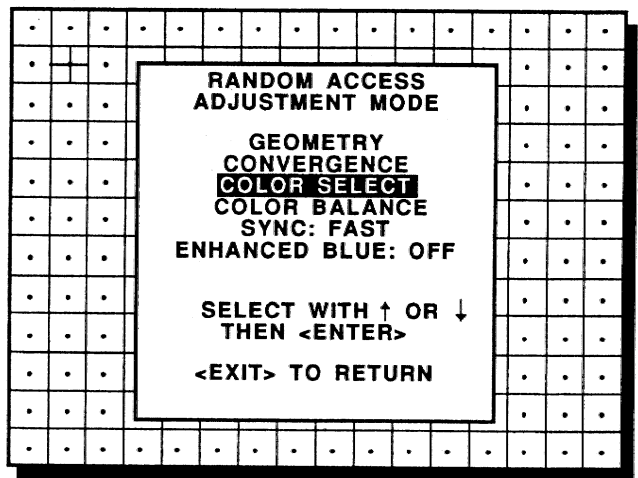

menu R1

<ENTER> continues to the color select menu, menu R2
<EXIT> will return to Internal Crosshatch Selection (Menu S4) or Setup Pattern Selection (Menu S2)
<ADJUST> returns to operational mode

RANDOM ACCESS ADJUSTMENT MODE

Use the arrow keys to highlight a color (CRT) or combination thereof to display the projected image from.

To select a new color, press **ENTER**, menu R2 appears again on the screen. To terminate the color select procedure, press **EXIT**.

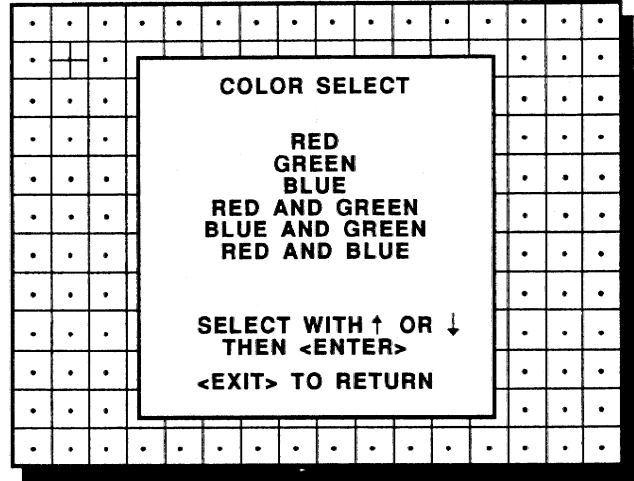

menu R2

<ENTER> continues with color select menu (Menu R2)
<EXIT> will return to menu R1.

Color balance

Highlight *Color balance* with the arrow keys and press **ENTER** to display menu R10.

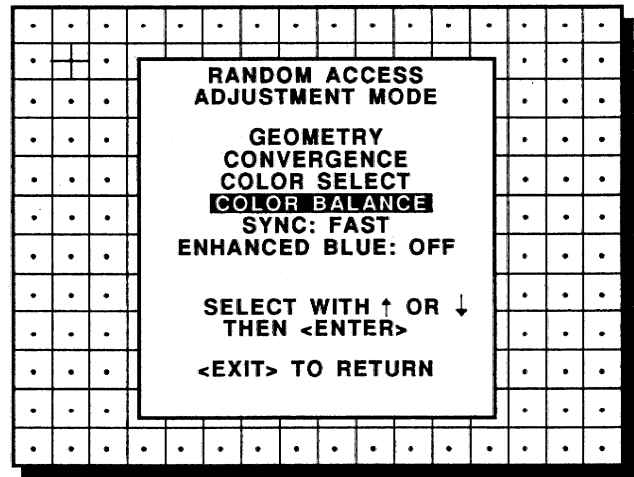

menu R1

<ENTER> continues with the color balance adjustment.
<EXIT> returns to Internal Crosshatch Selection (Menu S4) or Setup Pattern Selection (Menu S2)
<ADJUST> returns to operational mode.

RANDOM ACCESS ADJUSTMENT MODE

White balance

Use the arrow keys to select a *white balance* and press **ENTER**.

The table below lists the possible choices:

3200°K
6500°K
9300°K
CUSTOM

When custom is selected, the gain for Red and Blue can be adjusted with the arrow keys until the desired white balance is obtained.

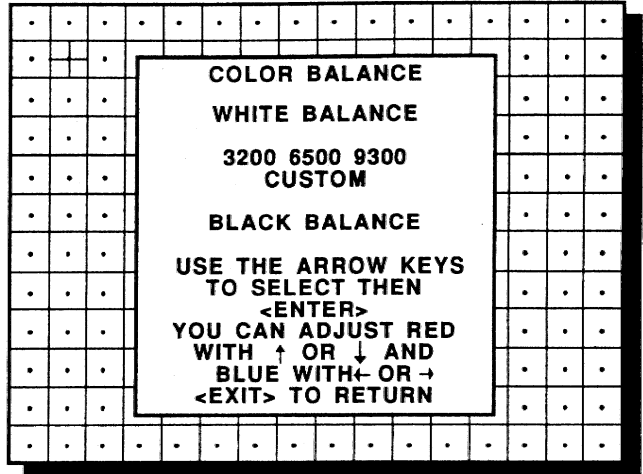

menu R10

Use the left and right arrow keys to adjust the Red gain. Use the up and down arrow keys to adjust the Blue gain.

<ENTER> returns to menu R1, and stores the selected white balance.
<EXIT> returns to menu R1
<ADJUST> returns to operational mode.

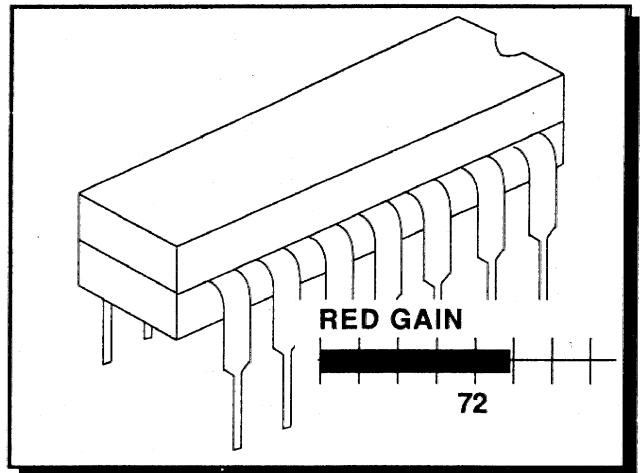

RANDOM ACCESS ADJUSTMENT MODE

Black balance

Use the arrow keys to select *black balance* and then press **ENTER**.

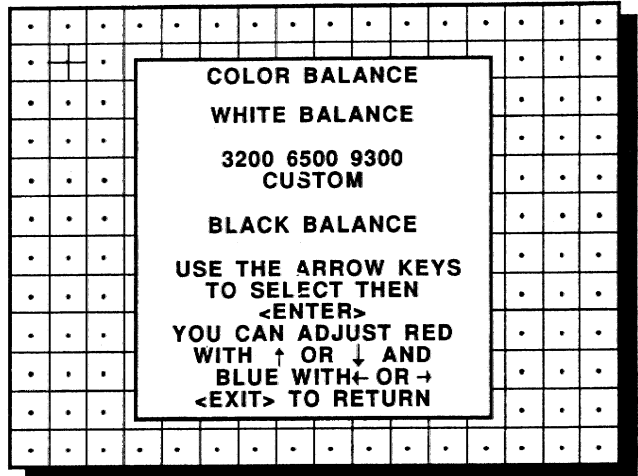

menu R10

<ENTER> selects the black balance adjustment.
<EXIT> returns to Random Access Adjustment Mode main menu (Menu R1).
<ADJUST> returns to operational mode.

Use the left and right arrow keys to adjust the 'blue cut off' and use the top and bottom arrow keys to adjust the 'red cut off'. Both adjustments give the correct *black balance*'.

A bar scale and a number indicator on the screen give a visual indication of the 'cut off' adjustment.

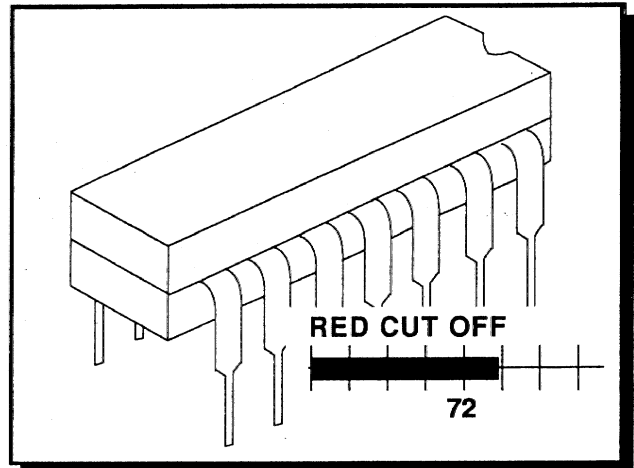

<ENTER> returns to the Color Adjustments menu, menu R10.

RANDOM ACCESS ADJUSTMENT MODE

Horizontal Phase Adjustment

Use the arrow keys to highlight *H PHASE* on menu R4 and then press **ENTER**.

Adjust the horizontal phase with the arrow keys until full characters are displayed on the left and right side of the picture. Therefore :
if the genlocked pattern was selected, the external source will be displayed

Note : no horizontal phase adjustment possible on internal # pattern.

A bar scale and a number indicator on the screen give a visual indication of the horizontal phase adjustment.

In order to optimize the image quality, the image should be shifted to the 'end of scan' side of the raster. For front screen applications, the 'end of scan' side of the raster is on the right hand side of the screen. For rear screen applications, it is on the left hand side.

Decrease the contrast and increase the brightness level until the raster becomes visible on the screen. Use the left or right

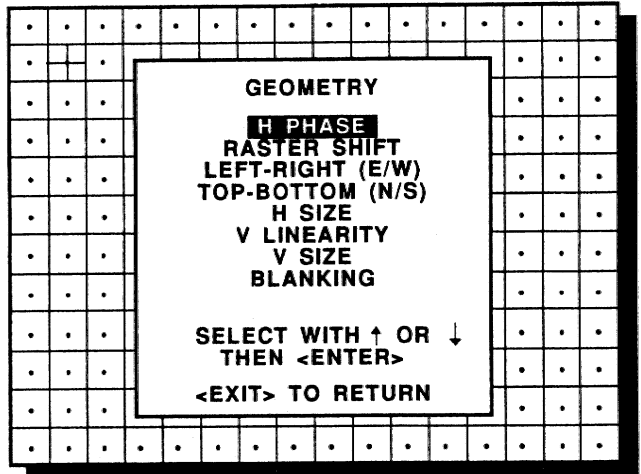

menu R4

<ENTER> will select horizontal phase adjustment
<EXIT> returns to random access adjustment mode menu, menu R1.
<ADJUST> returns operational mode

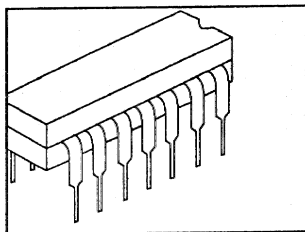
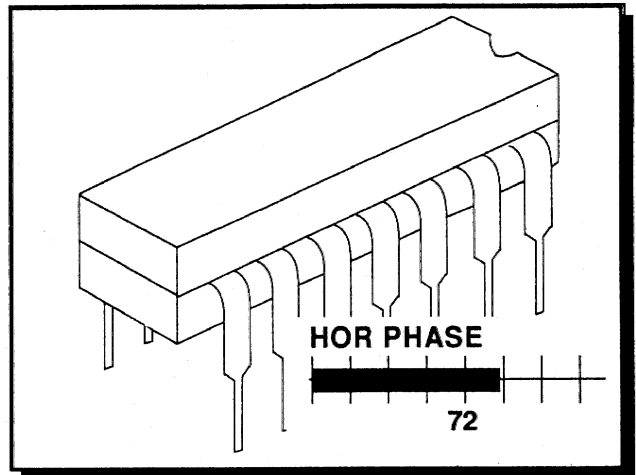

Correct with
right arrow key

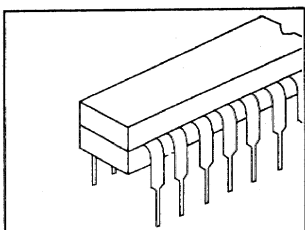

Correct with
left arrow key

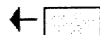

arrow keys to shift the setup pattern to the proper position on the raster.
Restore the brightness and contrast to normal levels after performing the horizontal phase adjustment.

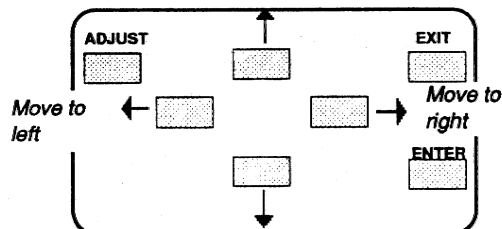

<ENTER> continues to geometry menu (Menu R4)

RANDOM ACCESS ADJUSTMENT MODE

Raster Shift Adjustment

The green raster must be centered both horizontally and vertically on the center of the CRT surface. To center the green raster, look into the green lens and use the arrow keys to move the raster.

CAUTION

It is necessary to look into the lenses to perform the following adjustments. To avoid eye discomfort while looking into the lenses, reduce the contrast and gradually increase the brightness level until the raster becomes visible on the face of the CRT.

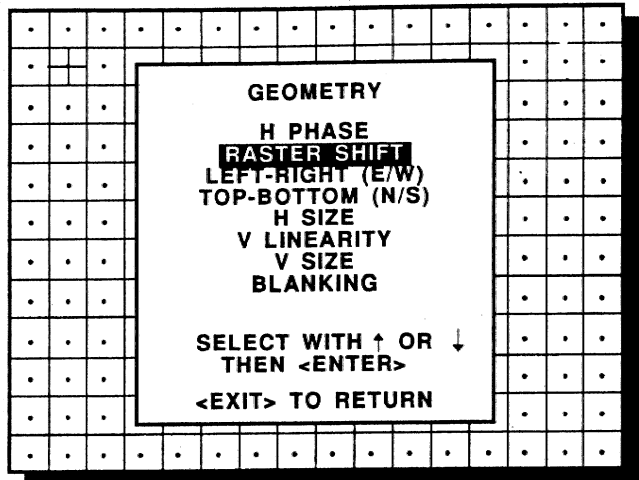

menu R4

<ENTER> will select green raster shift adjustment
 <EXIT> returns to random access adjustment mode menu, menu R1.
 <ADJUST> returns to operational mode

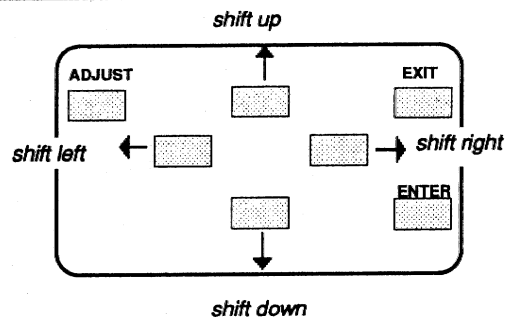
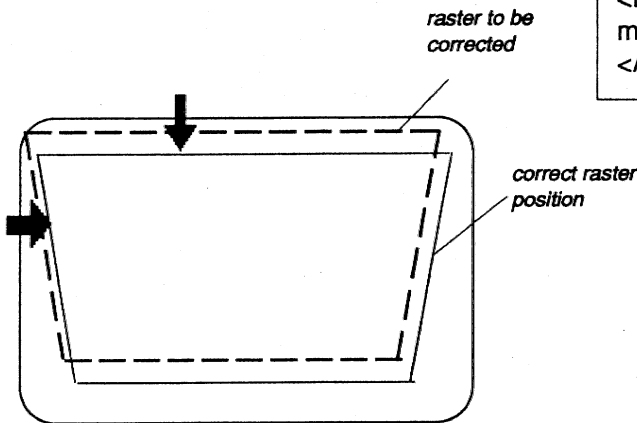

<EXIT> will return to Geometry (Menu R4)

Warning : In order to ensure maximum CRT longevity and to avoid CRT damage, do not shift the raster outside the phosphor area of the CRT.

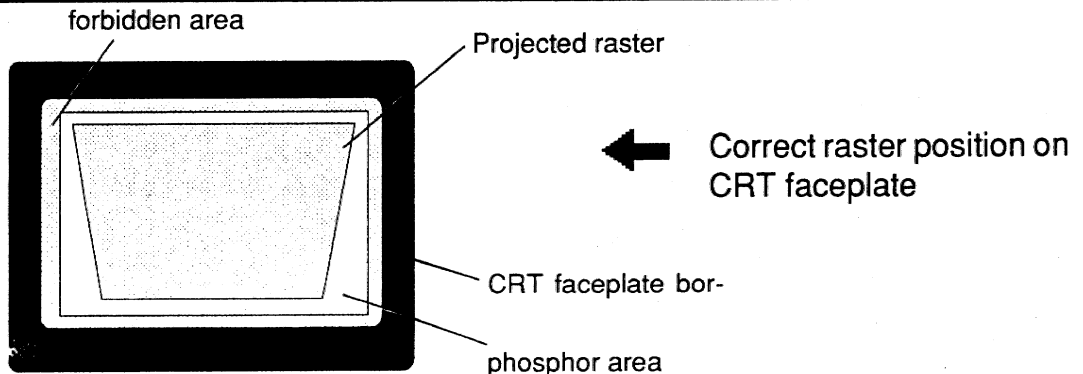

RANDOM ACCESS ADJUSTMENT MODE

Left-Right (east-west) Adjustments

Left-right adjustments affect only the vertical lines of the projected image. Only the green image is displayed while making left-right adjustments. The red and blue images will automatically be corrected in the same manner. Convergence corrections are automatically disabled for the duration of these adjustments.

The following adjustments can be executed

- vertical centerline bow
- vertical centerline skew
- side keystone
- side bow

Use the arrow keys to highlight *LEFT-RIGHT (E/W)* on menu R4 and then press **ENTER**.

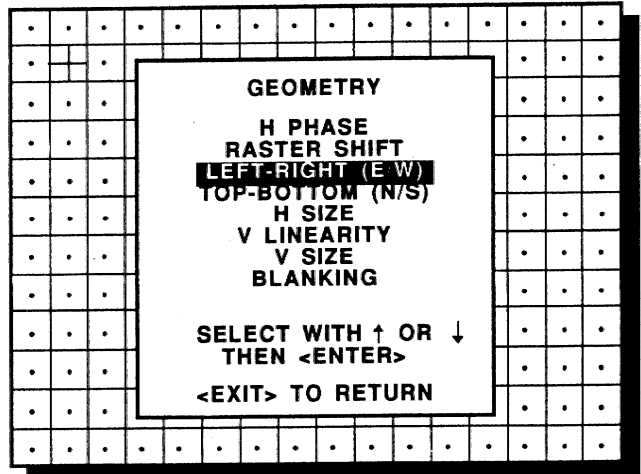

menu R4

<ENTER> will select Left-Right adjustment menu (Menu R7)
<EXIT> returns to random access adjustment menu, menu R1.
<ADJUST> returns to operational mode

RANDOM ACCESS ADJUSTMENT MODE

Vertical Centerline Bow Adjustment

Use the arrow keys to highlight *V CENTERLINE BOW* on Menu R7 and then press **ENTER**.

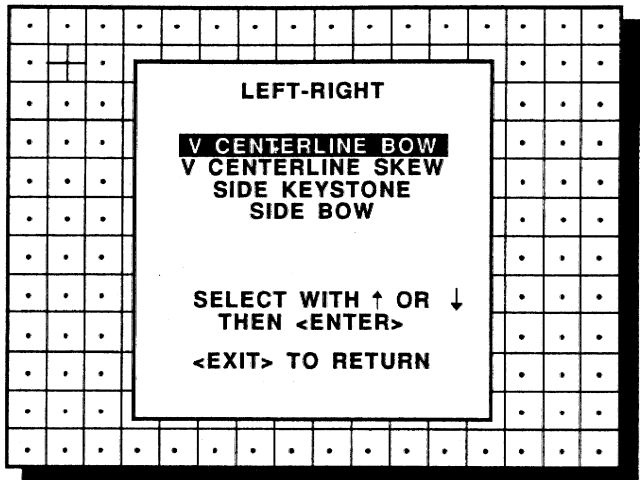

menu R7

<ENTER> will select vertical centerline bow adjustment
 <EXIT> will return to Geometry menu (Menu R4)
 <ADJUST> returns to operational mode

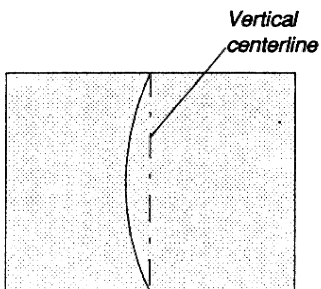
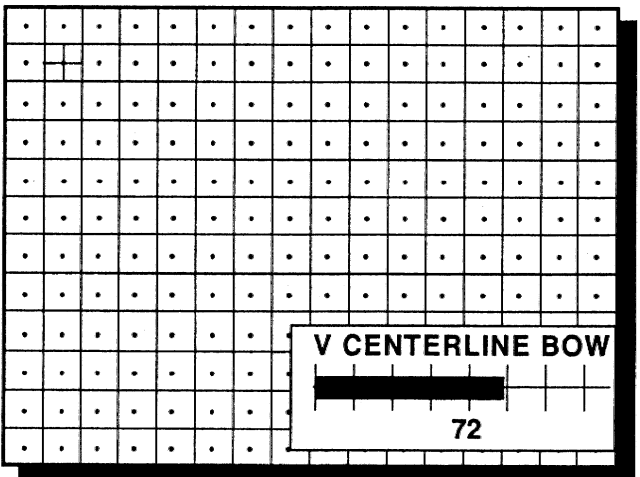

Correct with left arrow key

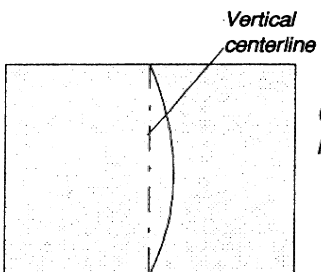

Correct with right arrow key

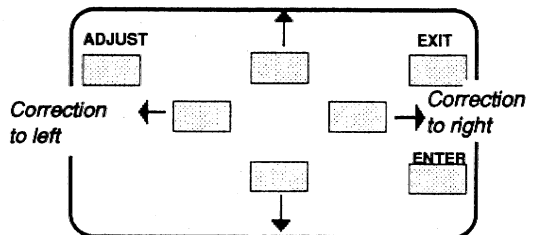

<ENTER> will return to Left-Right adjustment menu (Menu R7)
 <EXIT> will return to Geometry menu (Menu R4)

RANDOM ACCESS ADJUSTMENT MODE

Vertical Centerline Skew Adjustment

Use the arrow keys to highlight **V CENTERLINE SKEW** on Menu R7 and then press **ENTER**

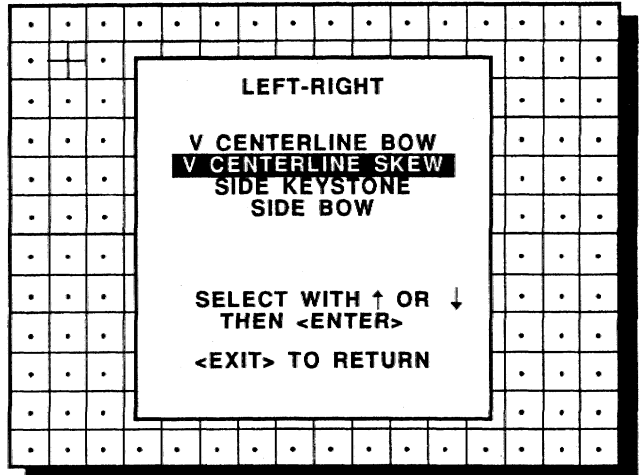

menu R7

<ENTER> will select vertical centerline skew adjustment
 <EXIT> will return to Geometry menu (Menu R4)
 <ADJUST> returns to operational mode

Adjust with the left and right arrow key until the vertical centerline is straight. Misalignment of the outer vertical lines will be corrected with the bow and keystone corrections. Press **ENTER** to continue.

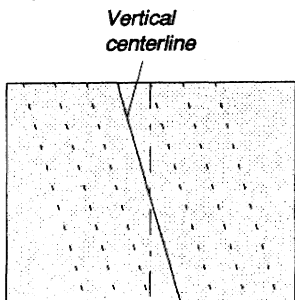
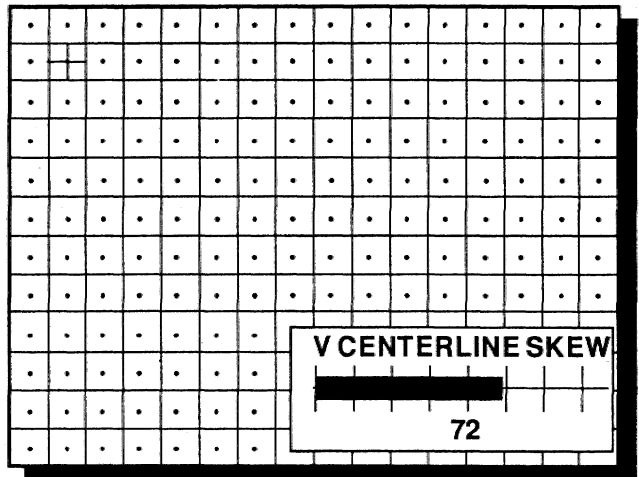

Correct with right arrow key

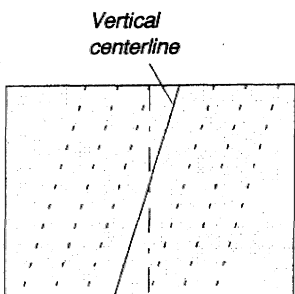

Correct with left arrow key

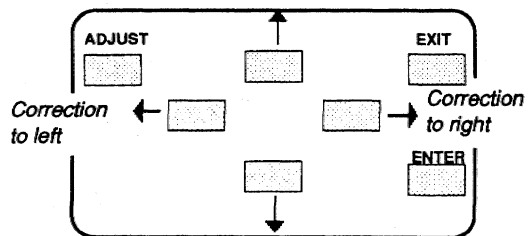
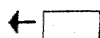

<ENTER> will return to Left-Right adjustment menu (Menu R7)
 <EXIT> will return to Geometry menu (Menu R4)

RANDOM ACCESS ADJUSTMENT MODE

Side Keystone Adjustment

Use the arrow keys to highlight *SIDE KEYSTONE* on Menu R7 and then press **ENTER**.

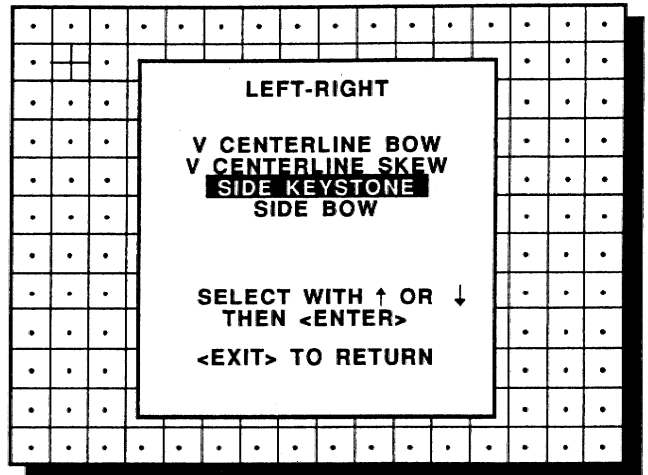

menu R7

<ENTER> will select side keystone adjustment
 <EXIT> will return to Geometry menu (Menu R4)
 <ADJUST> returns to operational mode

Use the left or right arrow key to adjust the side keystone (vertical lines) of the setup pattern and press **ENTER** to continue.

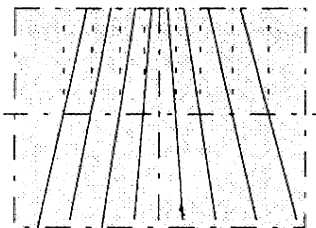
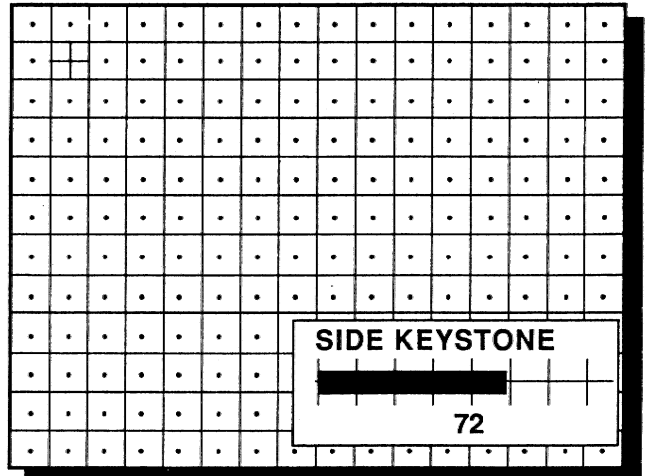

Correct with
right arrow key

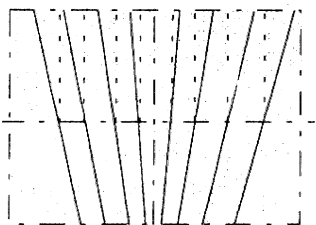

Correct with
left arrow key

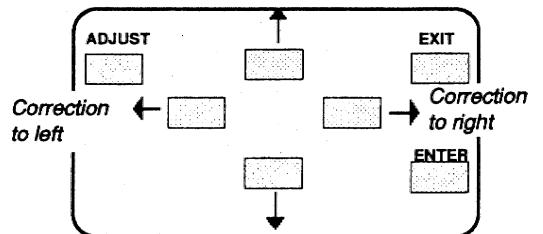

<ENTER> will return to Left-Right adjustment menu (Menu R7)
 <EXIT> will return to Geometry menu (Menu R4)

RANDOM ACCESS ADJUSTMENT MODE

Side Bow Adjustment

Use the arrow keys to highlight *SIDE BOW* on Menu R7 and then press **ENTER**.

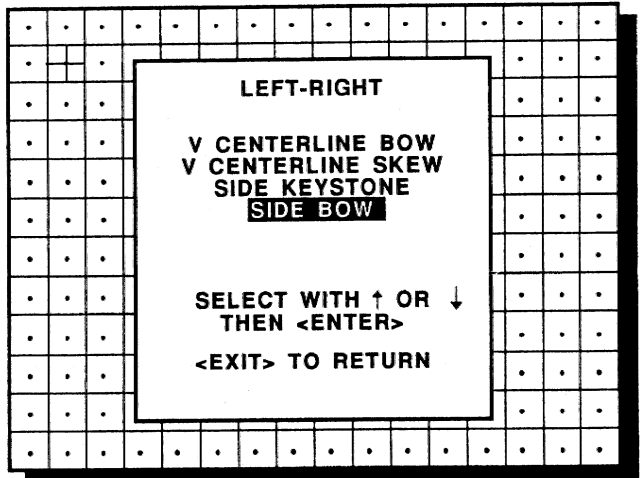

menu R7

<ENTER> will select side bow adjustment
 <EXIT> will return to Geometry menu (Menu R4)
 <ADJUST> returns to operational mode

Use the left or right arrow key to adjust the side bow of the setup pattern (vertical lines) and press **ENTER** to continue.

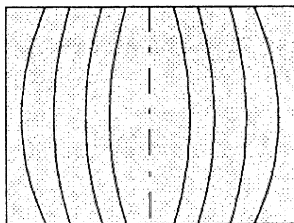
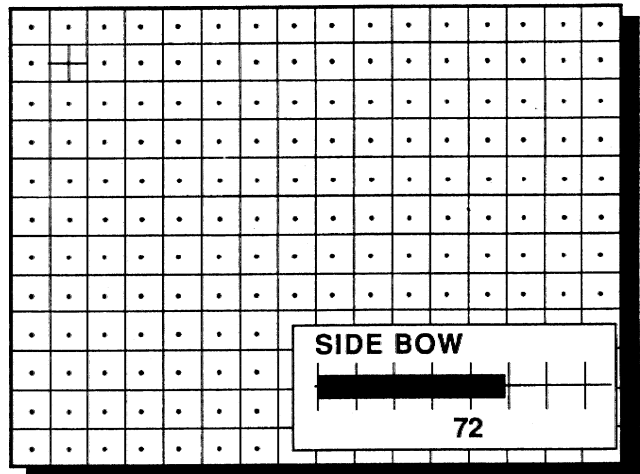

Correct with right arrow key

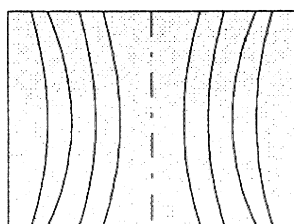

Correct with left arrow key

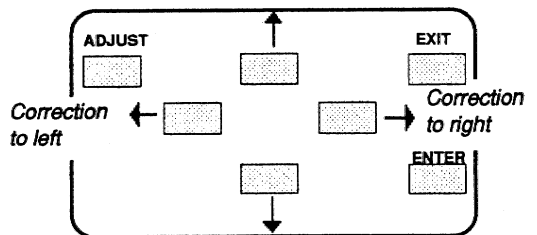

<ENTER> will return to Left-Right adjustment menu (Menu R7)
 <EXIT> will return to Geometry menu (Menu R4)

RANDOM ACCESS ADJUSTMENT MODE

Top-Bottom (north-south) Adjustments

Top-Bottom adjustments affect only the horizontal lines of the projected image. Convergence corrections are automatically disabled for the duration of these adjustments.

Use the arrow keys to highlight *TOP-BOTTOM (N/S)* on menu R4 and then press **ENTER**.

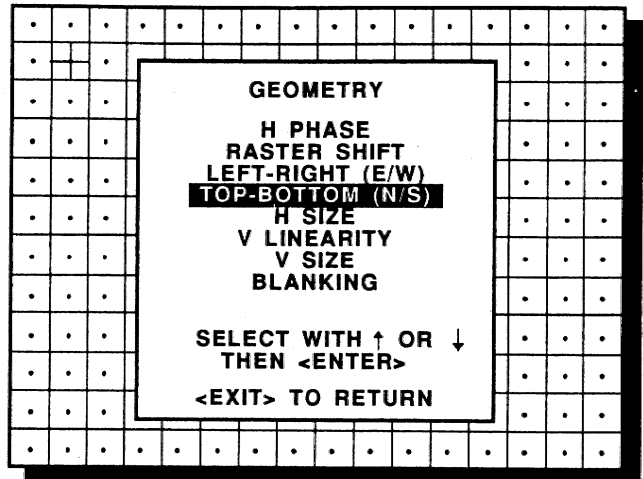

menu R4

<ENTER> will select Top-Bottom adjustment menu (Menu R8)
<EXIT> returns to random access adjustment mode menu, menu R1.
<ADJUST> returns to operational mode

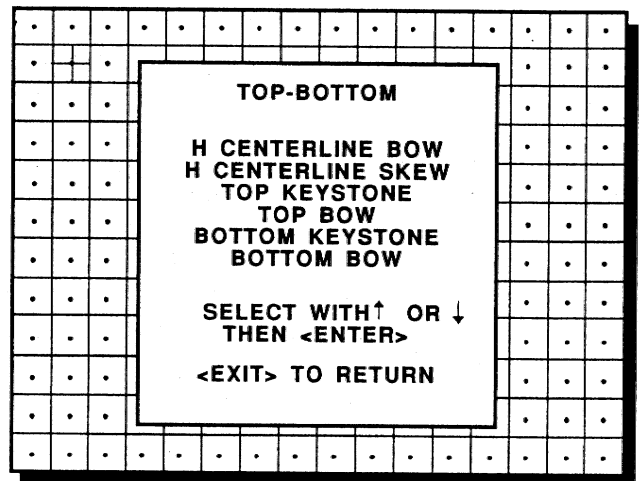

menu R8

<EXIT> will return to Geometry (Menu R4)

RANDOM ACCESS ADJUSTMENT MODE

Horizontal Centerline Bow Adjustment

Use the arrow keys to highlight *H CENTERLINE BOW* on menu R8 and then press **ENTER**.

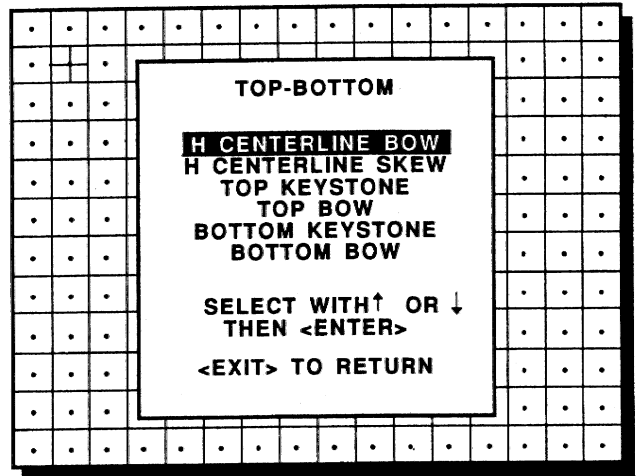

menu R8

<ENTER> will select horizontal centerline bow adjustment
 <EXIT> will return to Geometry menu (Menu R4)
 <ADJUST> returns to operational mode

Use the up and down arrow key to adjust the horizontal centerline bow of the setup pattern. A bar scale and a number indicator will give a visual indication of the bow correction.

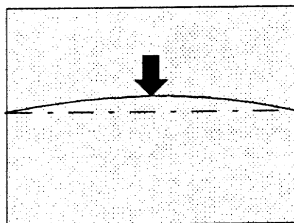
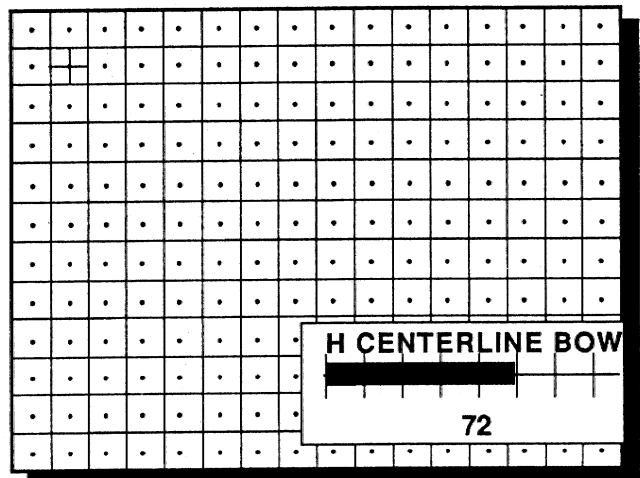

Correct with down arrow key

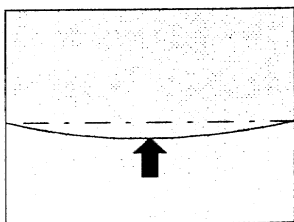

Correct with up arrow key

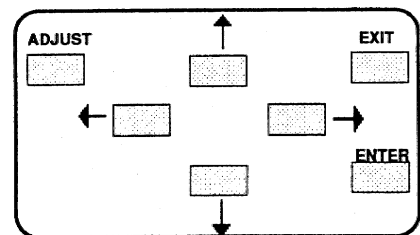

<ENTER> will return to Top-Bottom adjustment menu (Menu R8)
 <EXIT> will return to Geometry menu (Menu R4)

RANDOM ACCESS ADJUSTMENT MODE

Horizontal Centerline Skew Adjustment

Use the arrow keys to highlight *H CENTERLINE SKEW* on menu R8 and then press **ENTER**.

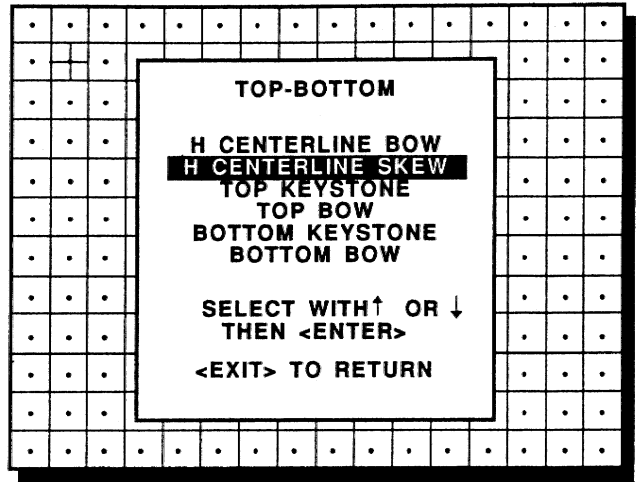

menu R8

<ENTER> will select horizontal centerline skew adjustment
 <EXIT> will return to Geometry menu (Menu R4)
 <ADJUST> returns to operational mode

Use the up and down arrow key to adjust the horizontal centerline skew of the setup pattern.

A bar scale and a number indicator will give a visual indication of the skew correction.

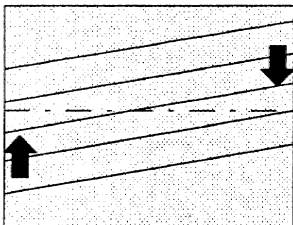
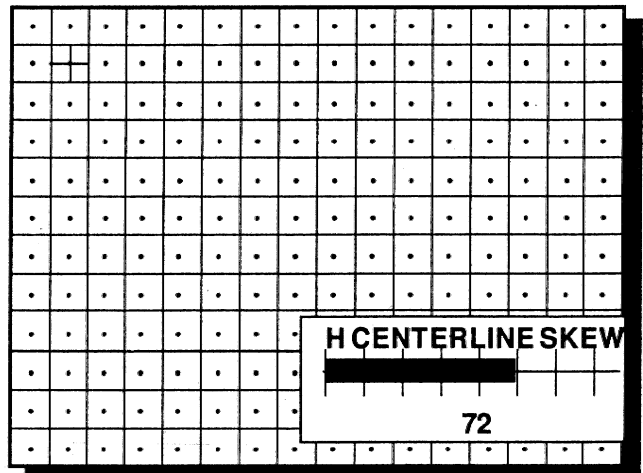

Correct with up arrow key

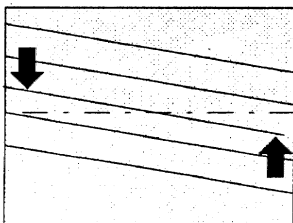

Correct with down arrow key

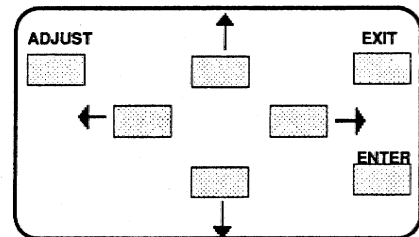

<ENTER> will return to Top-Bottom adjustment menu (Menu R8)
 <EXIT> will return to Geometry menu (Menu R4)

RANDOM ACCESS ADJUSTMENT MODE

Top Keystone Adjustment

Use the arrow keys to highlight **TOP KEYSTONE** on menu R8 and then press **ENTER**.

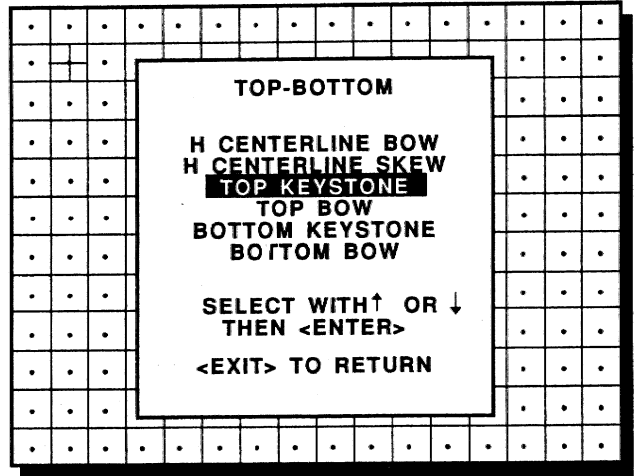

menu R8

<ENTER> will select top keystone adjustment
 <EXIT> will return to Geometry menu (Menu R4)
 <ADJUST> returns to operational mode

Adjust the horizontal lines in the upper part of the picture with the arrow keys until these lines straight. Press **ENTER** to continue.

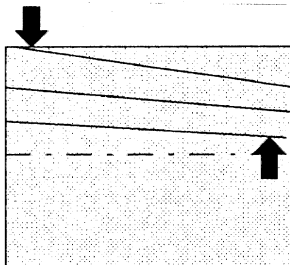
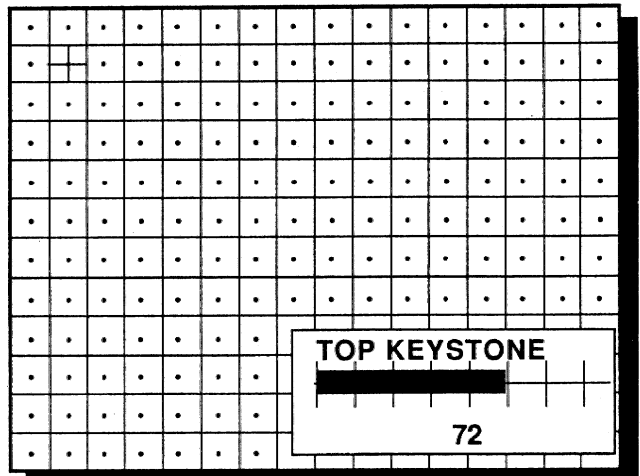

Correct with up arrow key

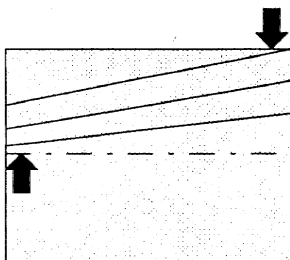

Correct with down arrow key

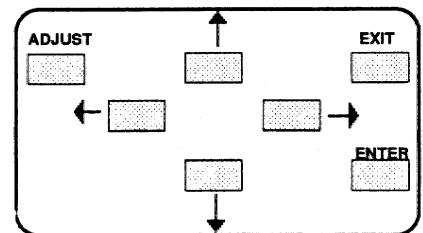

<ENTER> will return to Top-Bottom adjustment menu (Menu R8)
 <EXIT> will return to Geometry menu (Menu R4)

RANDOM ACCESS ADJUSTMENT MODE

Top Bow Adjustment

Use the arrow keys to highlight *TOP BOW* on menu R8 and then press **ENTER**.

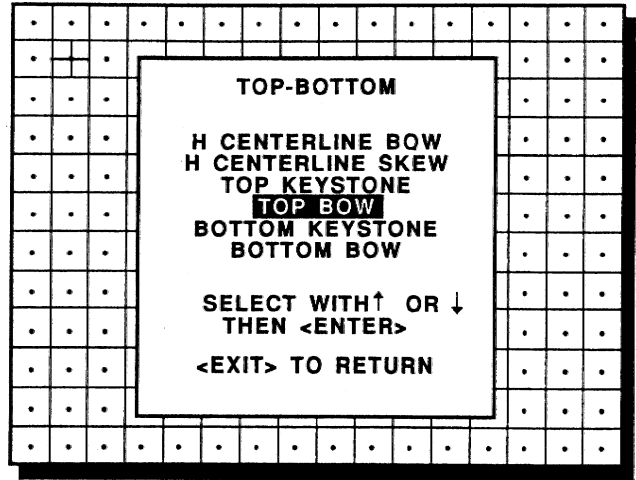

menu R8

<ENTER> will select top bow adjustment
 <EXIT> will return to Geometry menu (Menu R4)
 <ADJUST> returns to operational mode

Adjust the bow of the horizontal lines in the upper side of the image with the arrow keys until these lines are straight. A bar scale and a number indicator indicate the amount of adjustment.

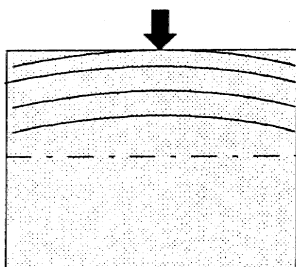
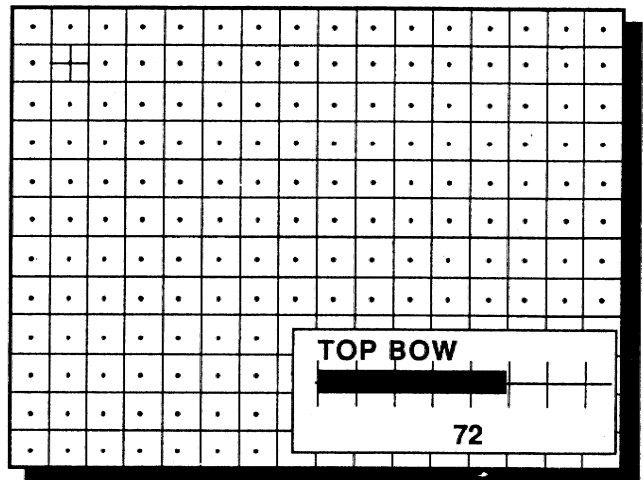

Correct with
downarrow key

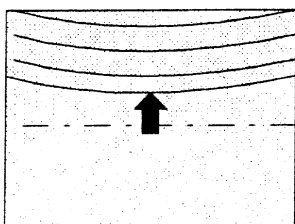

Correct with up
arrow key

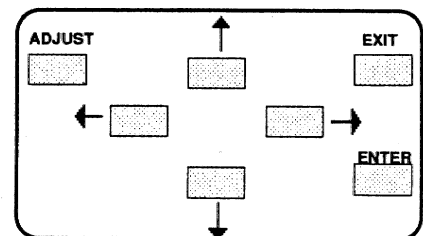

<ENTER> will return to Top-Bottom adjustment menu (Menu R8)
 <EXIT> will return to Geometry menu (Menu R4)

RANDOM ACCESS ADJUSTMENT MODE

Bottom Keystone Adjustment

Use the arrow keys to highlight *BOTTOM KEYSTONE* on menu R8 and then press **ENTER**.

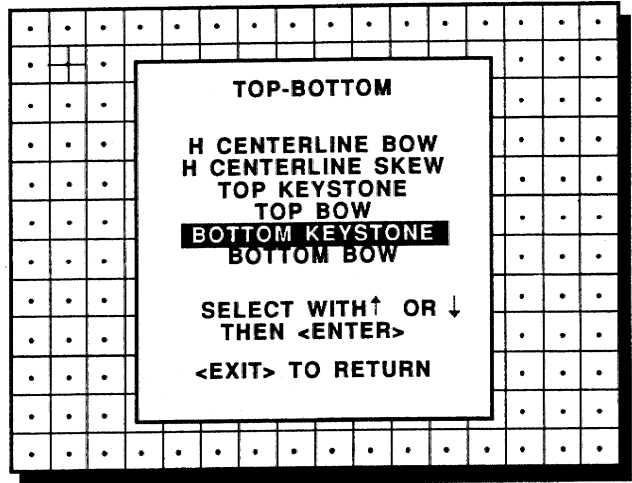

menu R8

<ENTER> will select bottom keystone adjustment
 <EXIT> will return to Geometry menu (Menu R4)
 <ADJUST> returns to operational mode

Adjust the horizontal lines in the lower part of the image with the arrow keys until these lines are straight. A bar scale and a number indicator will give a visual indication of the adjustment.

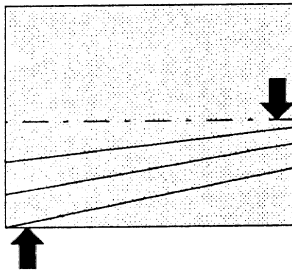
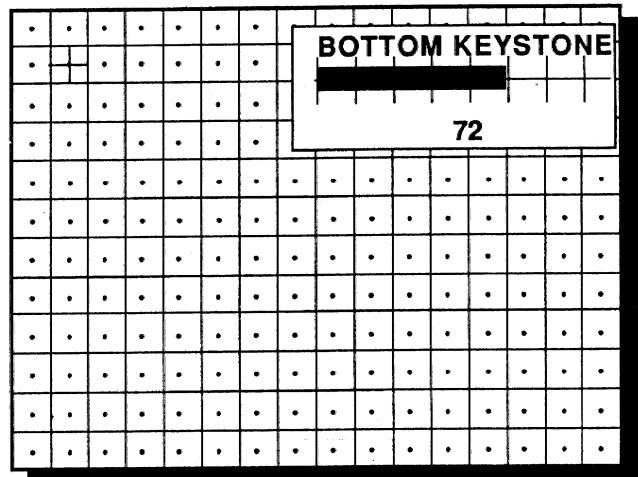

Correct with
down arrow key

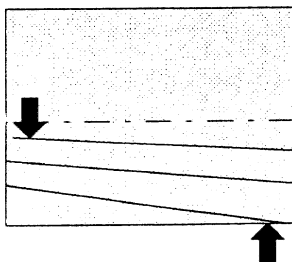

Correct with up
arrow key

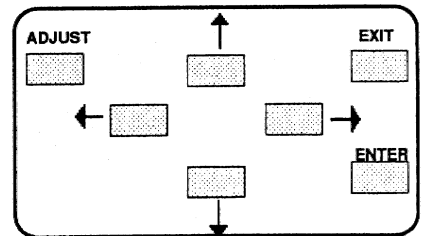

<ENTER> will return to Top-Bottom adjustment menu (Menu R8)
 <EXIT> will return to Geometry menu (Menu R4)

RANDOM ACCESS ADJUSTMENT MODE

Bottom Bow Adjustment

Use the arrow keys to highlight *BOTTOM BOW* on menu R8 and then press **ENTER**.

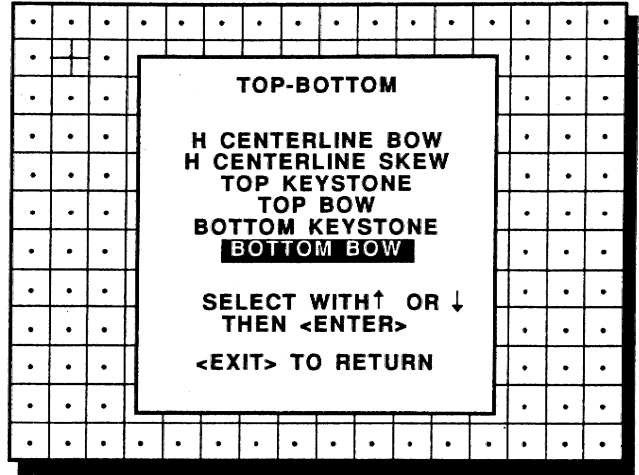

menu R8

<ENTER> will select bottom bow adjustment
 <EXIT> will return to Geometry menu (Menu R4)
 <ADJUST> returns to operational mode

Use the up and down arrow key to adjust the bottom bow in the lower part of the setup pattern. Adjust until the horizontal lines are straight. A bar scale and a number indicator give a visual indication of the adjustment.

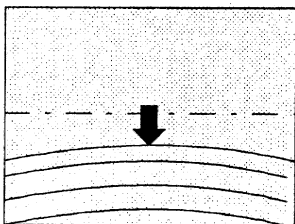
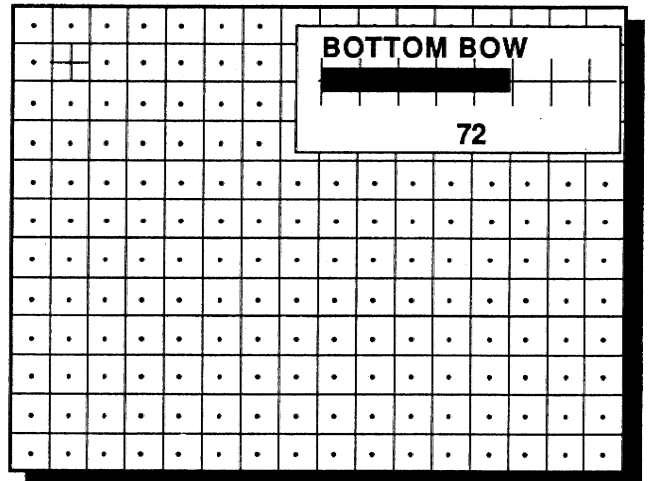

Correct with
down arrow key

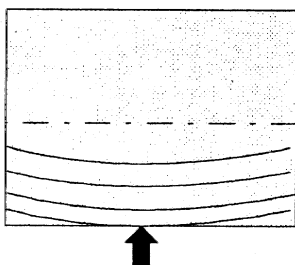

Correct with up
arrow key

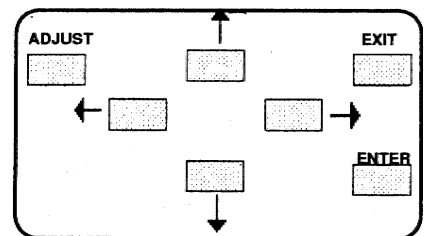

<ENTER> will return to Top-Bottom adjustment menu (Menu R8)
 <EXIT> will return to Geometry menu (Menu R4)

RANDOM ACCESS ADJUSTMENT MODE

Horizontal Size Adjustment

Use the arrow keys to highlight *H SIZE* on menu R4 and then press **ENTER**.

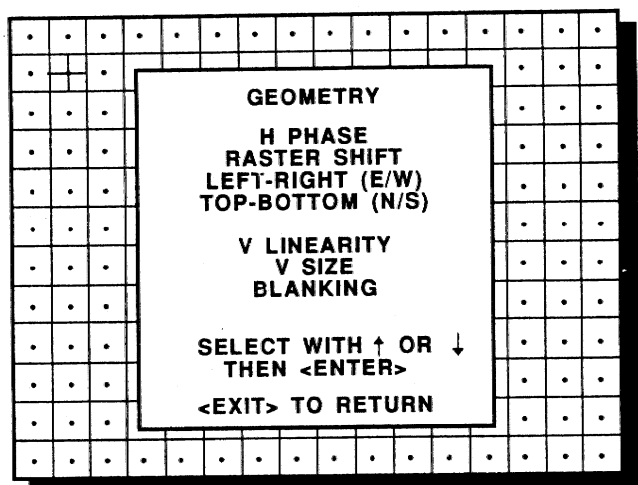

menu R4

<ENTER> will select horizontal size adjustment
 <EXIT> returns to random access adjustment menu, menu R1.
 <ADJUST> returns to operational mode

Adjust the horizontal size with the left and right arrow key until the exact image width is obtained.

Therefore :

- if the internal # pattern was selected, this pattern remains on the screen.
- if the genlocked pattern was selected, the external source will be displayed.

A bar scale and a number indicator give a visual indication of the horizontal size adjustment.

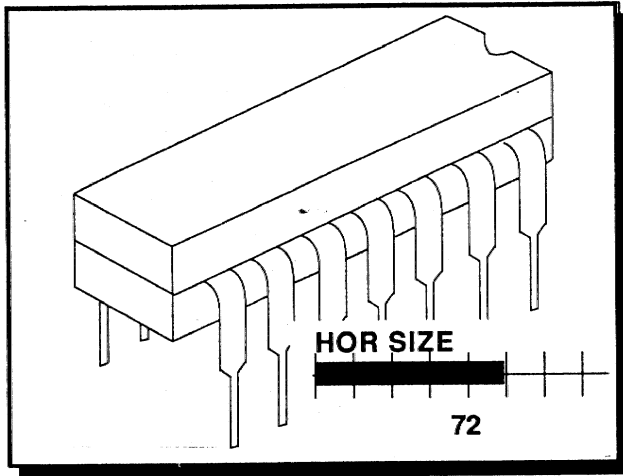

Hint : In order to avoid loss of resolution in the projected image and to ensure maximum CRT longevity, do not use an excessively small horizontal size setting.

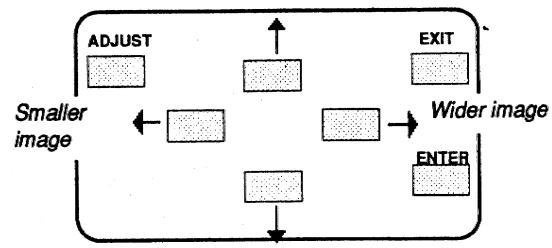
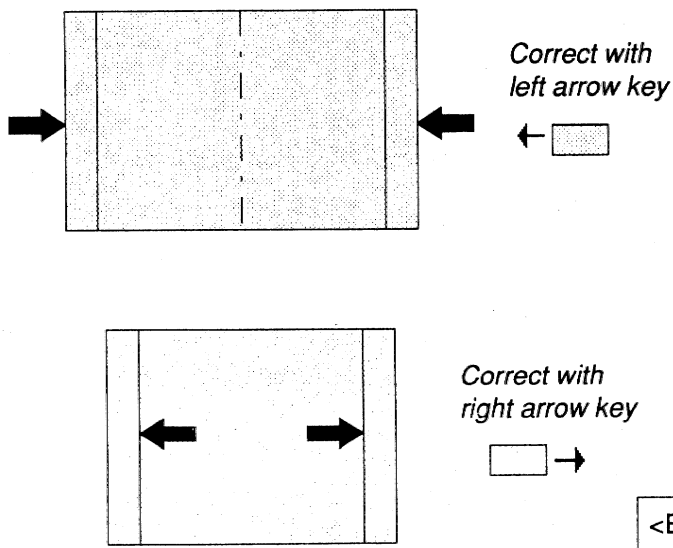

<EXIT> will return to Geometry (Menu R4)

RANDOM ACCESS ADJUSTMENT MODE

Vertical Linearity Adjustment

Use the arrow keys to highlight *V LINEARITY* on menu R4 and then press **ENTER**.

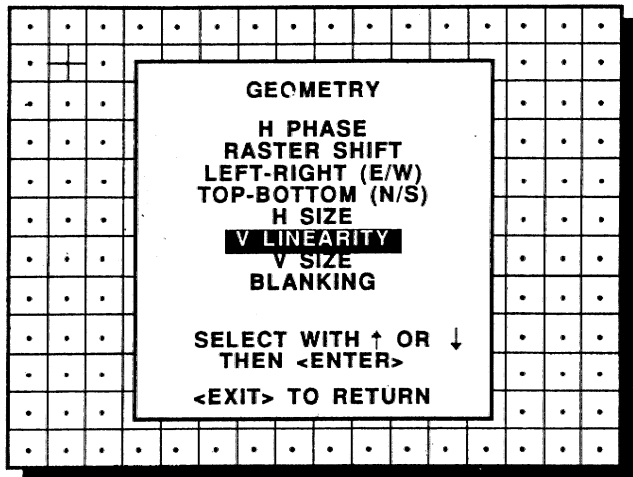

menu R4

<ENTER> will select vertical linearity adjustment
 <EXIT> returns to random access adjustment menu, menu R1.
 <ADJUST> returns to operational mode

Adjust the vertical linearity with the arrow keys until the distances between the horizontal lines of the set up pattern are equal.

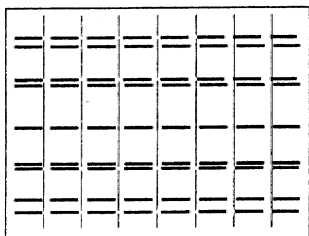
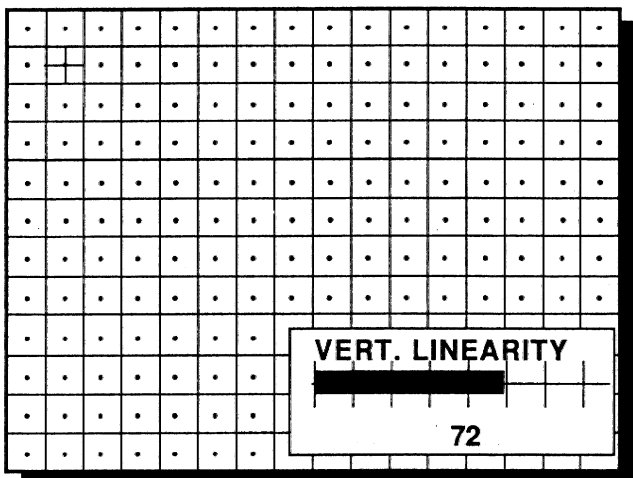

Correct with up arrow key

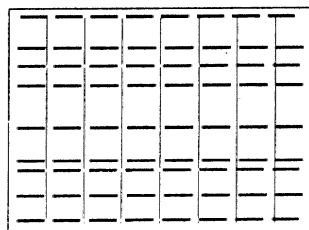

Correct with down arrow key

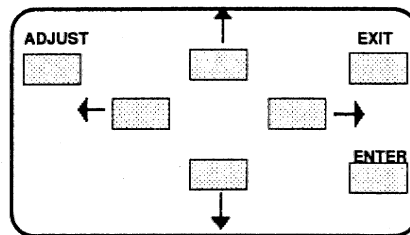

<EXIT> will return to Geometry (Menu R4)

RANDOM ACCESS ADJUSTMENT MODE

Vertical Size Adjustment

Use the arrow keys to highlight *V SIZE* on menu R4 and then press **ENTER**.

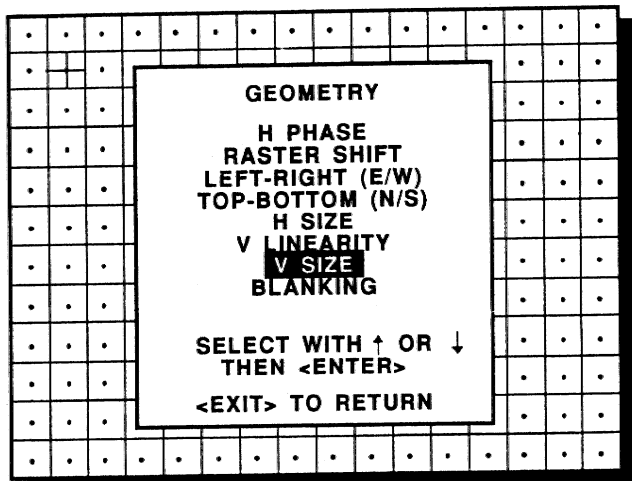

menu R4

<ENTER> will select vertical size adjustment
 <EXIT> returns to random access adjustment mode menu, menu R1.
 <ADJUST> returns to operational mode

Adjust the vertical size with the up or down arrow key until the exact image height is obtained. Therefore :

- if the internal # pattern was selected, this pattern remains on the screen.
- if the genlocked pattern was selected, the external source will be displayed.

A bar scale and a number indicator give a visual indication of the vertical size adjustment.

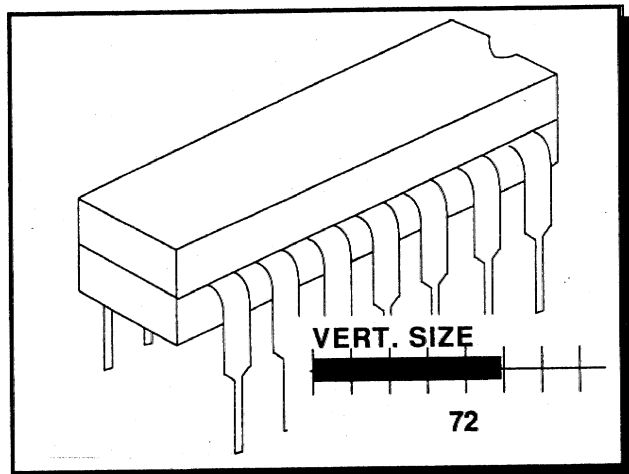

Hint : In order to avoid loss of resolution in the projected image and to ensure maximum CRT longevity, do not use an excessively small vertical size setting.

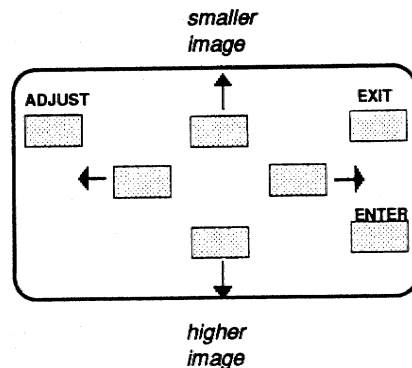
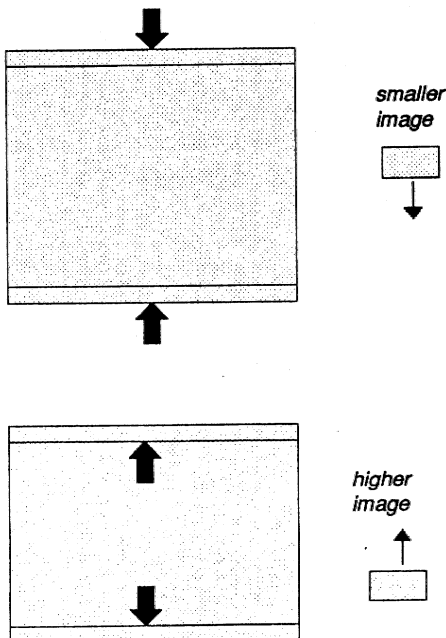

<EXIT> will return to Geometry (Menu R4)

Blanking Adjustments

Use the arrow keys to highlight **BLANKING** on menu R4 and then press **ENTER**.

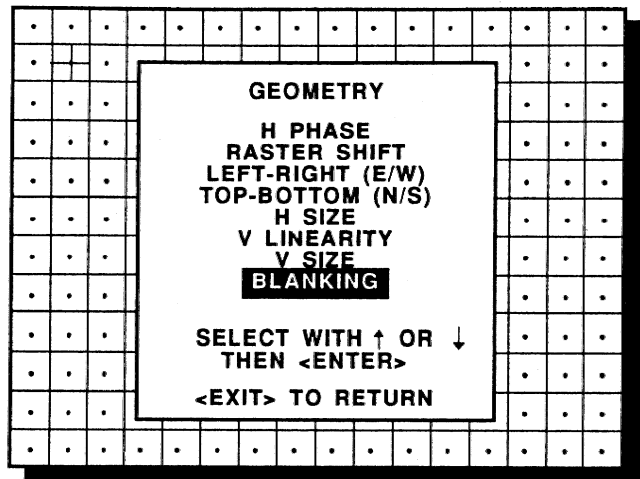

menu R4

<ENTER> will select blanking adjustment menu (Menu R8)
 <EXIT> returns to random access adjustment mode menu, menu R1.
 <ADJUST> returns to operational mode

Blanking adjustments affect only the edges of the projected image and are used to frame the projected image on to the screen. The following blanking corrections are possible :

- top blanking
- bottom blanking
- left blanking
- right blanking

Therefore :

- if the internal # pattern was selected, this pattern remains on the screen.
- if the genlocked pattern was selected, the external source will be displayed.

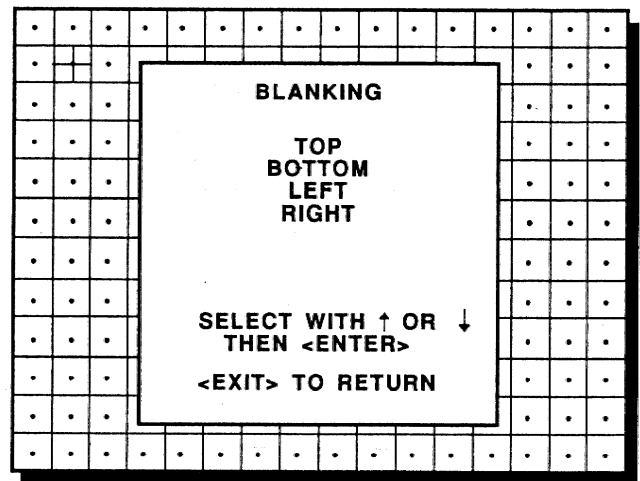

menu R9

<EXIT> will return to Geometry (Menu R4)
 <ADJUST> returns to operational mode

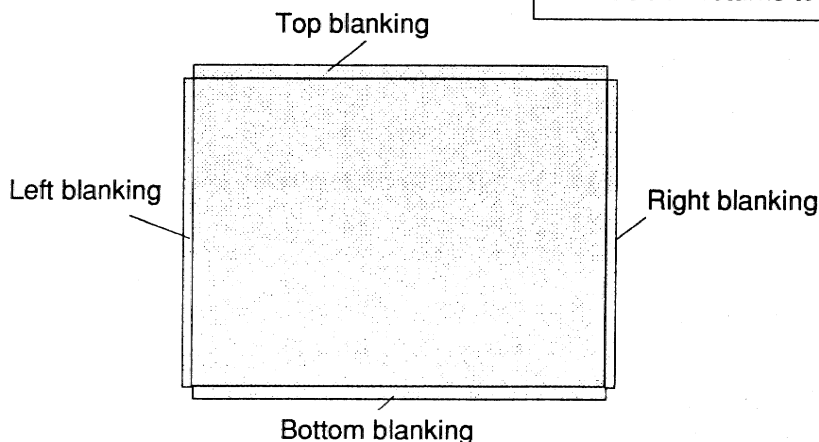

RANDOM ACCESS ADJUSTMENT MODE

Top Blanking Adjustment

Use the arrow keys to highlight **TOP** on menu R9 and then press **ENTER**.

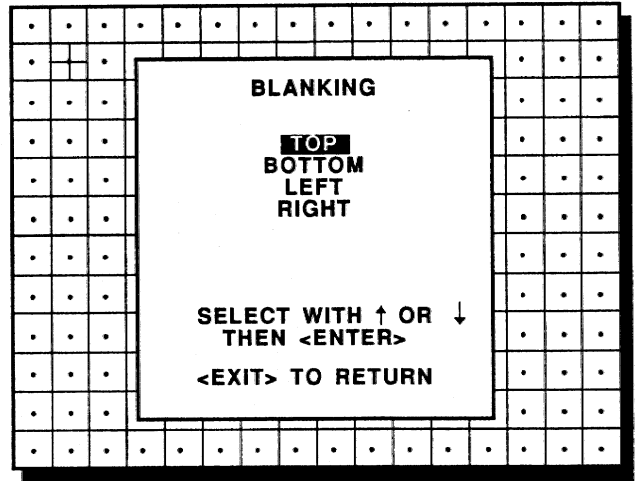

menu R9

<ENTER> will select top blanking adjustment
 <EXIT> will return to Geometry menu (Menu R4)
 <ADJUST> returns to operational mode

Use the arrow keys to adjust the top blanking. Press **ENTER** to continue

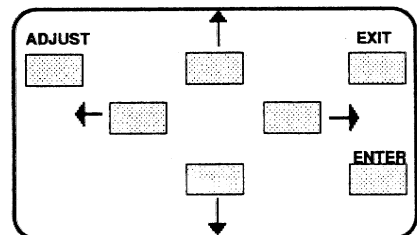
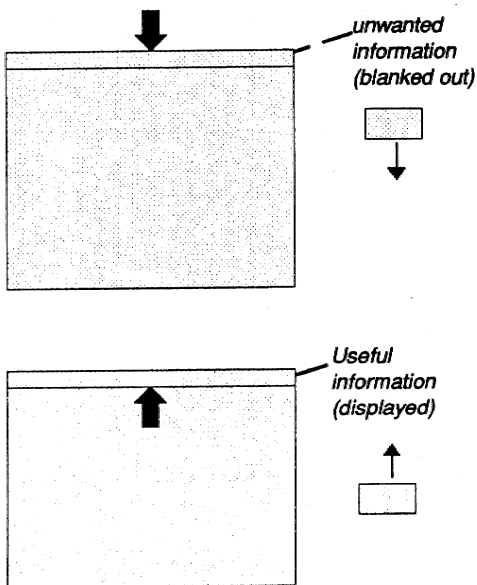
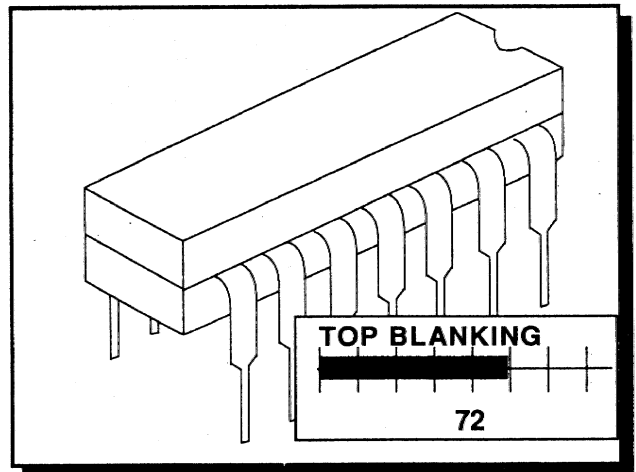

<EXIT> will return to Blanking (Menu R9)

RANDOM ACCESS ADJUSTMENT MODE

Bottom Blanking Adjustment

Use the arrow keys to highlight **BOTTOM** on menu R9 and then press **ENTER**.

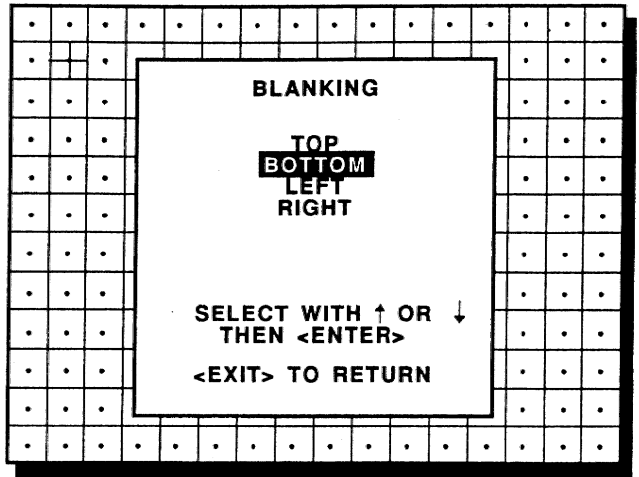

menu R9

<ENTER> will select bottom blanking adjustment
 <EXIT> will return to Geometry menu (Menu R4)
 <ADJUST> returns to operational mode

Use the arrow keys to adjust the top blanking. Press **ENTER** to continue

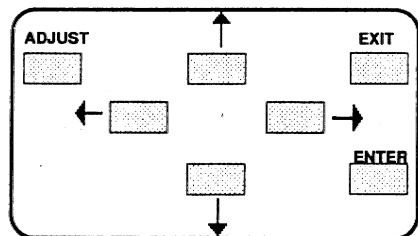
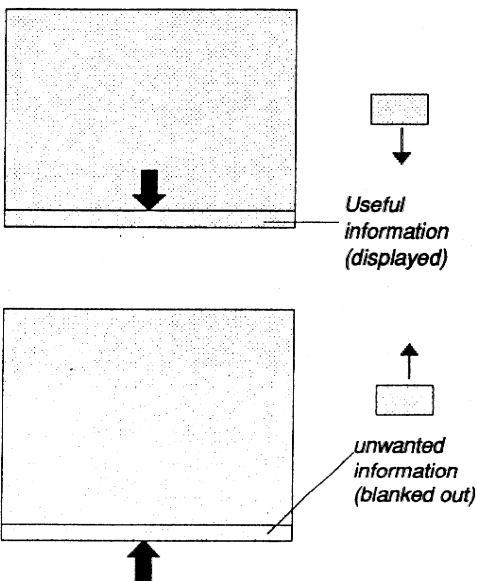
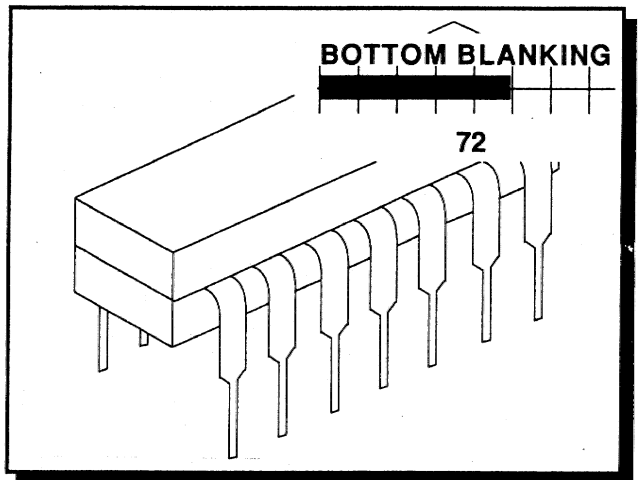

<EXIT> will return to Blanking (Menu R9)

RANDOM ACCESS ADJUSTMENT MODE

Left Blanking Adjustment

Use the arrow keys to highlight **LEFT** on menu R9 and then press **ENTER**.

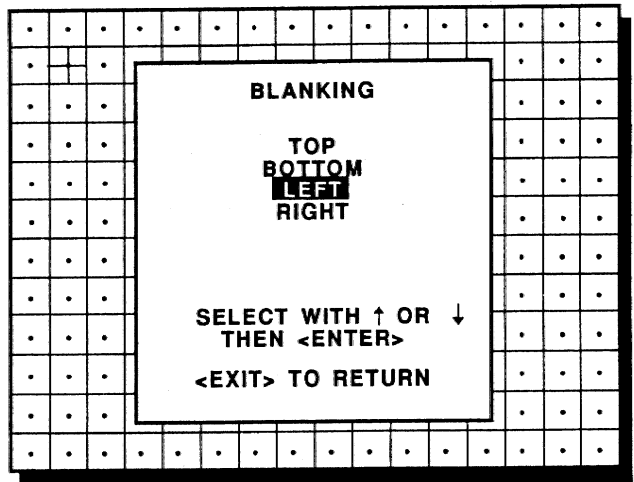

menu R9

<ENTER> will select left blanking adjustment
 <EXIT> will return to Geometry menu (Menu R4)
 <ADJUST> returns to operational mode

Use the arrow keys to adjust the left blanking. Press **ENTER** to continue

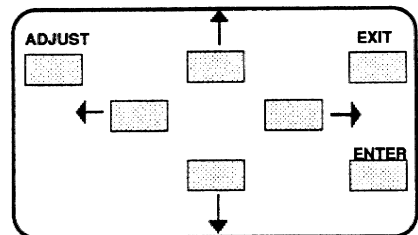
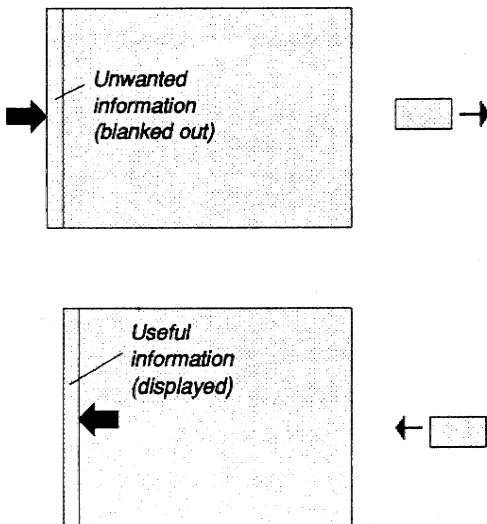
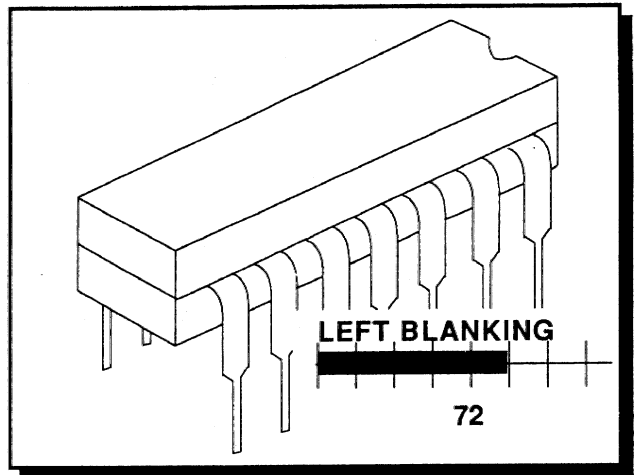

<EXIT> will return to Blanking (Menu R9)

Right Blanking Adjustment

Use the arrow keys to highlight *RIGHT* on menu R9 and then press **ENTER**.

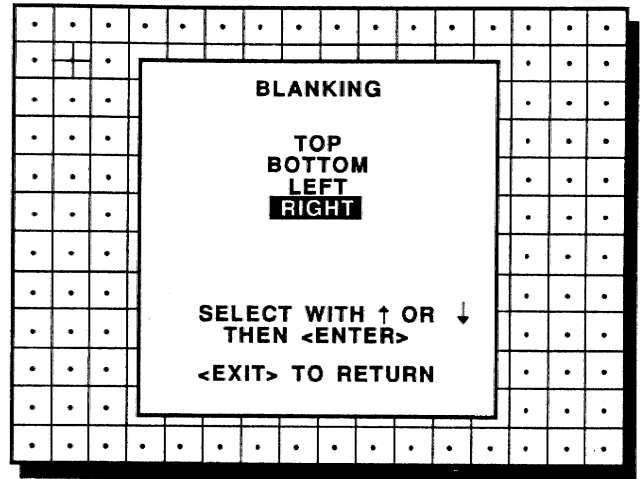

menu R9

<ENTER> will select right blanking adjustment
 <EXIT> will return to Geometry menu (Menu R4)
 <ADJUST> returns to operational mode

Use the arrow keys to adjust the right blanking. Press **ENTER** to continue

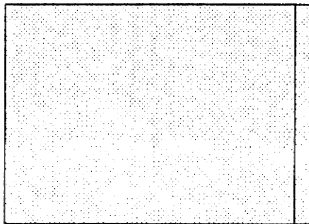
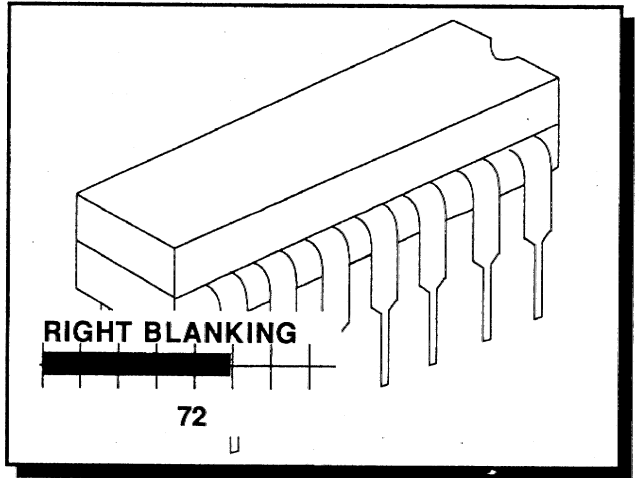

unwanted information (blanked out)
 ← []

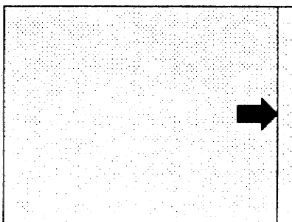

Useful information (displayed)
 [] →

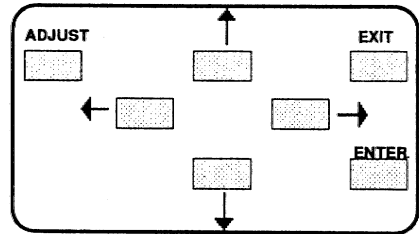

<EXIT> will return to Blanking (Menu R9)

Convergence adjustments

Convergence adjustments affect both the horizontal and vertical lines of the setup pattern. These adjustments are performed on the red image while superimposed on the green image and then on the blue image while superimposed on the green image.

Note : green convergence adjustments can be added as an option. When these are available, start always with 'green only'. This option will also be indicated on the convergence menu, menu R3.

Highlight first 'Green only' when available with the arrow keys and press ENTER to display menu R6.

Otherwise, highlight 'RED ON GREEN' or 'BLUE ON GREEN' with the arrow keys and press ENTER to display menu R6.

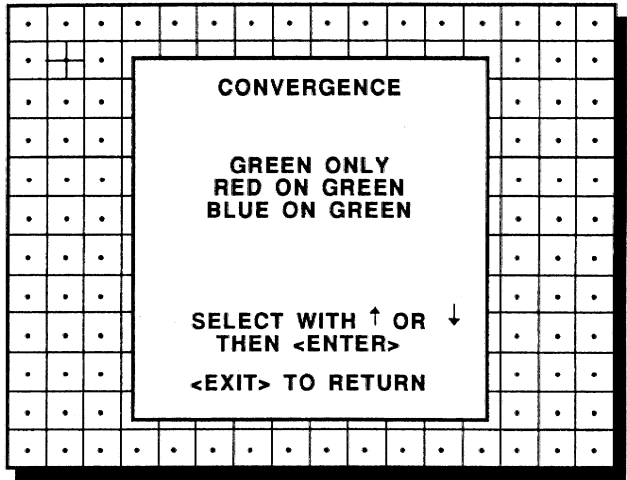

menu R3

<ENTER> will display Convergence menu (Menu R6)

<EXIT> will return to Random Access Adjustment Mode main menu (Menu R1)

<ADJUST> returns to operation mode.

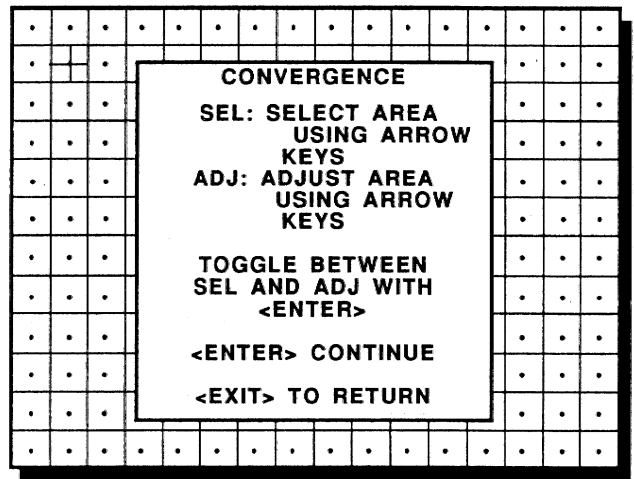

menu R6

<ENTER> will continue to convergence adjustment

<EXIT> returns to convergence menu, menu R3 .

RANDOM ACCESS ADJUSTMENT MODE

The projected image is divided into 13 convergence zones. Use the arrow keys to move the box to the desired zone and then press **ENTER** to begin the convergence adjustment. Start the convergence adjustment with zone one and continue as mentioned in the diagram hereafter.

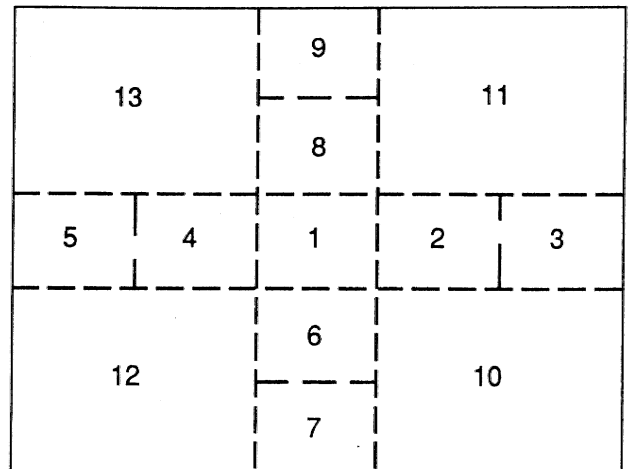

Use the arrow keys to make horizontal or vertical convergence adjustments in the selected zone and then press **ENTER** to move the box to another zone or **EXIT** to return to the Geometry-Converge menu (Menu R3).

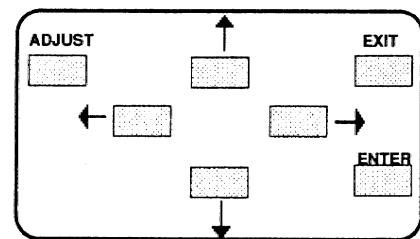
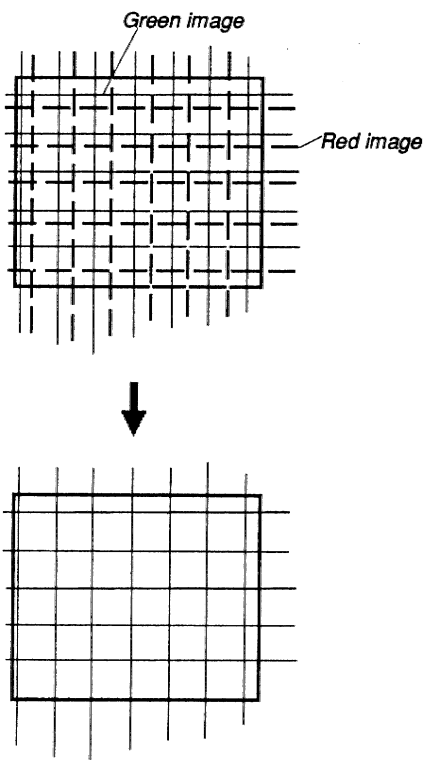
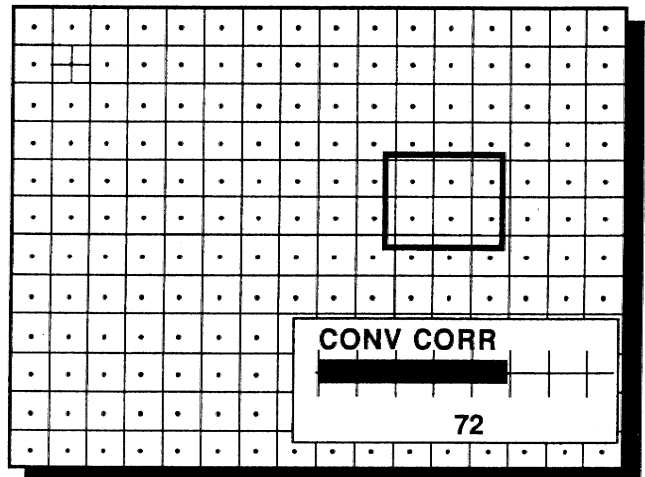

<ENTER> toggles arrow keys between zone selection and zone adjustment
 <EXIT> returns to convergence menu, menu R3.

SERVICE MODE

- START UP SCREEN
- COPY A BLOCK
- DELETE A BLOCK
- DELETE ALL BLOCKS
- CHANGE PASSWORD
- RUN TIME
- SET TO MIDPOSITION
- CONVERGENCE OFF

SERVICE MODE

Starting up the service mode.

Use the arrow keys on the RCU800 to highlight 'Service' and then press **ENTER**.

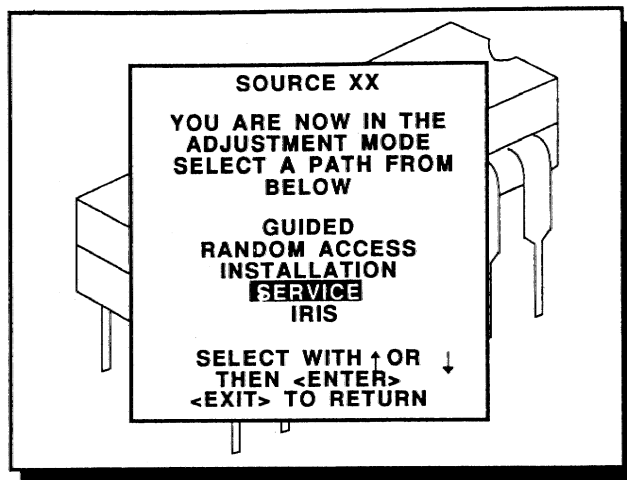

menu S1

<ENTER> continues to service mode, menu SE1.
<EXIT> returns to operational mode.

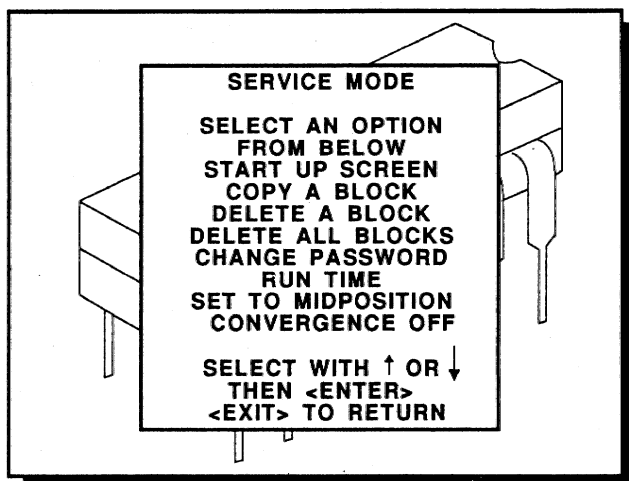

menu SE1

SERVICE MODE

Overview flow chart 'Service' mode.

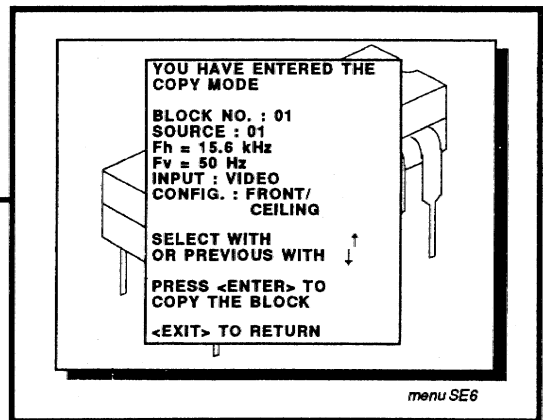
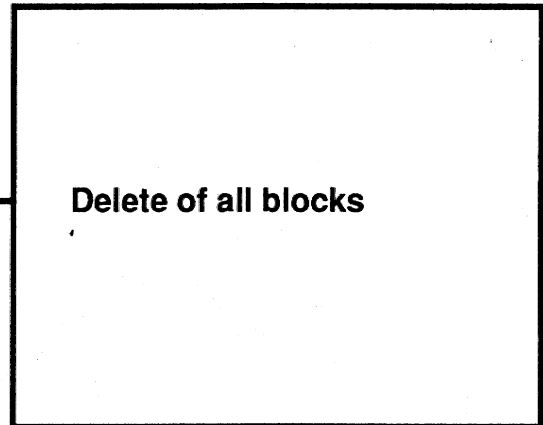
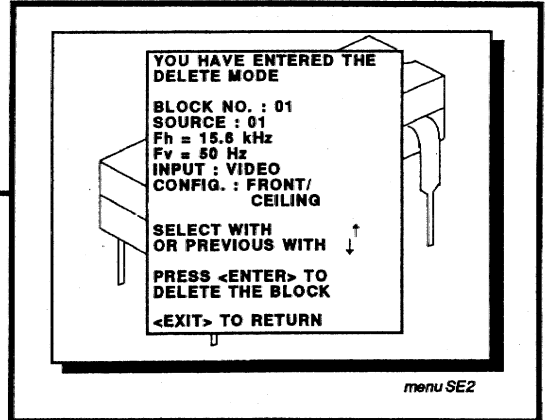
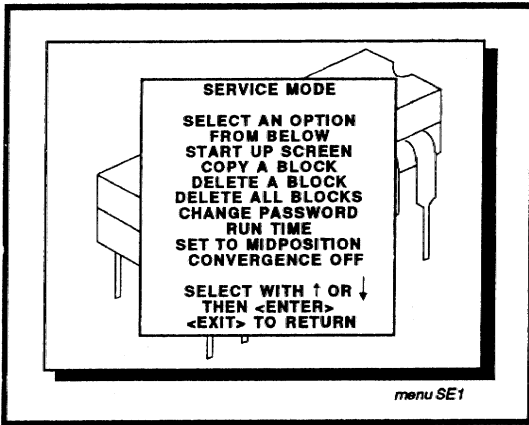

SERVICE MODE

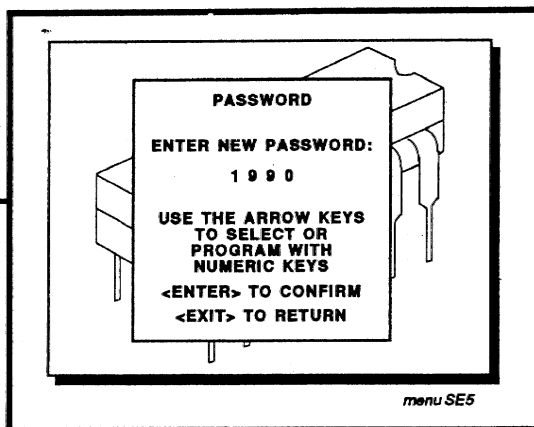
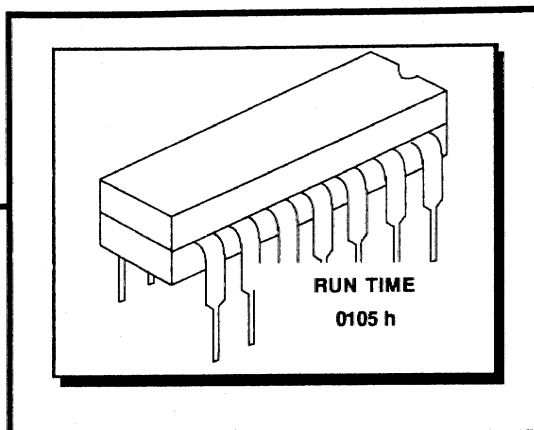

Set to midposition

Convergence off

SERVICE MODE

Start up screen.

Highlight 'Start up screen' with the arrow keys and press **ENTER**.

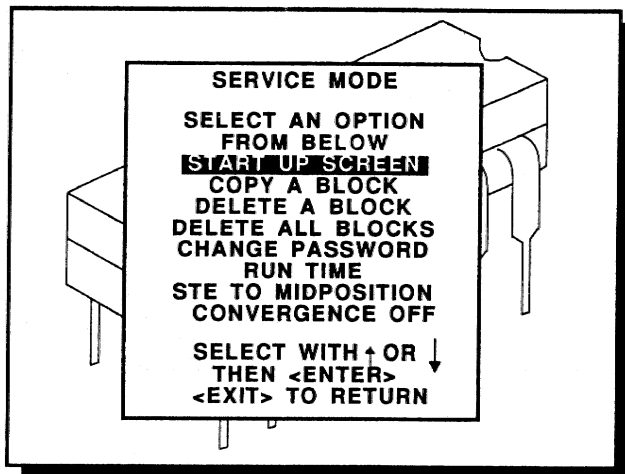

menu SE1

<ENTER> will start the selected item.
<EXIT> returns to the path selection menu, menu S1.

The 'Start up' screen gives information concerning :

- projector address. To change the address of your projector, contact a qualified service technician.
- software version.
- configuration.
possible installations :
 - * front-ceiling
 - * front-table
 - * rear-ceiling
 - * rear-table



BARCO start up screen

- baudrate PC : transfer speed for communication with a IBM PC (or compatible) or MAC. The baudrate of the projector must be the same as the baudrate of the connected computer. When there is a difference, contact a qualified service technician to change.
- Text ON/OFF
Indicates in operational mode if the bar scale and number indicator will be displayed and if warnings and failures will be displayed to.
ON : displayed
OFF : not displayed

The status can be changed when pressing once on the 'text' key of the RCU800.

- Serial no. : indicates the fabrication number of the projector. This number can be useful when calling for technical assistance.

Copy a block

To copy the settings of a closed block to the block you are working on. All existing setting will be overwritten with the new settings.

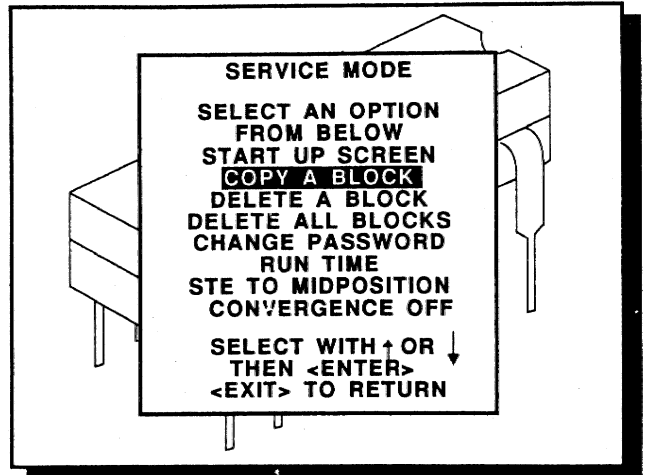

menu SE1

<ENTER> will select the pointed item.
<EXIT> returns to the path selection menu, menu S1.

A first block header will be displayed in menu SE6.

To select the desired block :

1. Use the up and down arrow keys on the RCU800 to scroll through the adjustment blocks. The contents of each block header are displayed on the copy menu, menu SE6.
2. Press **ENTER** to copy the selected adjustment block. A 'confirm' screen appear on the screen.
3. If you are sure to copy the block, press **ENTER**.
Exit returns without copy the block.

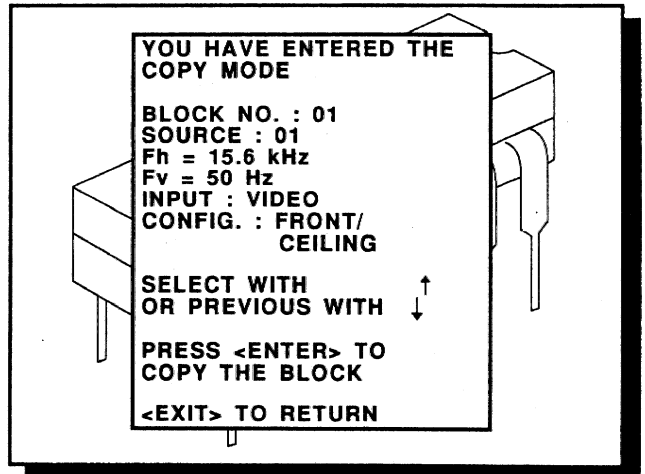

menu SE6

SERVICE MODE

Deletion of blocks

The delete function is used to clear all data (settings) from an adj. block (see appendix B for explanation about 'adjustment blocks')

A delete can be given :

- block per block
- or
- for all blocks.

Deleting block per block

Highlights 'Delete a block' with the arrow keys and press **ENTER**.

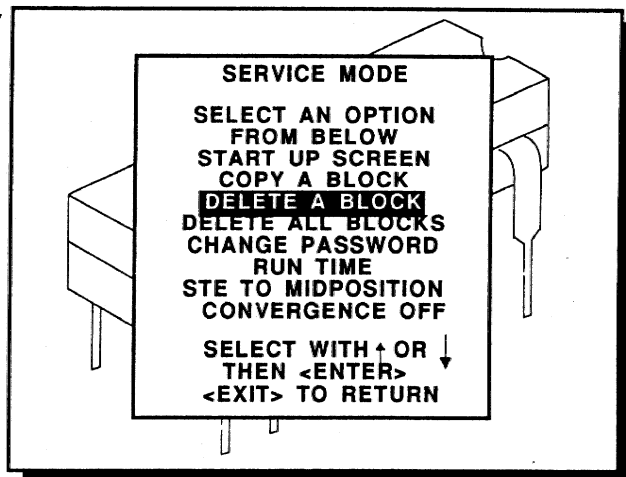

menu SE1

<ENTER> will select the pointed item.
<EXIT> returns to the path selection menu, menu S1.

A first block header will be displayed in menu SE3.

To select the desired block :

1. Use the up and down arrow keys on the RCU800 to scroll through the adjustment blocks. The contents of each block header are displayed on the delete menu, menu SE2.
2. Press **ENTER** to delete the selected adjustment block. A 'confirm' screen appear on the screen.

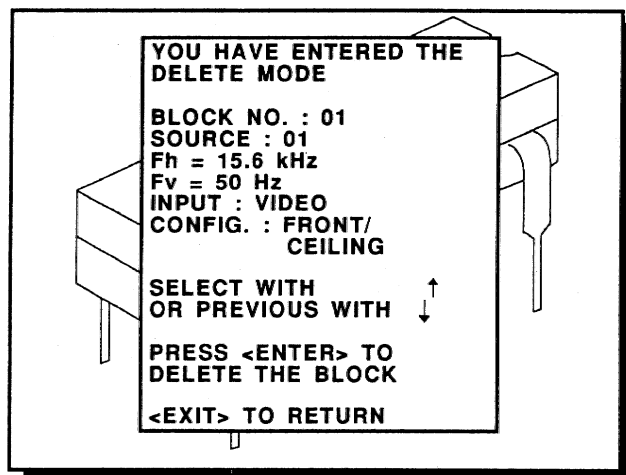

menu SE2

SERVICE MODE

3. If you are sure to delete the block, press **ENTER**. The deleted block number returns but all fields are blanked.

Once **ENTER** is pressed, the block header and adjustment settings are definitely removed and

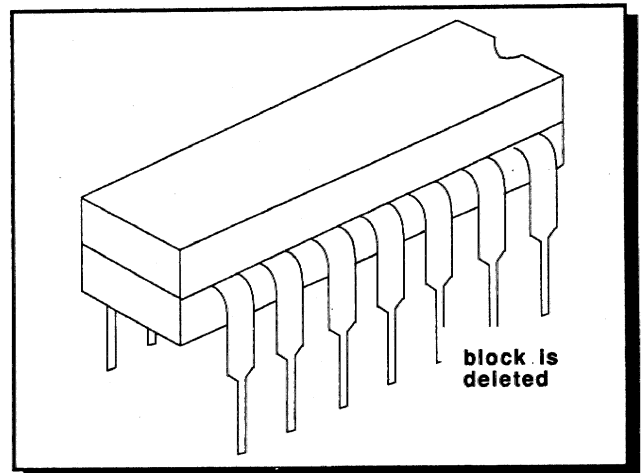
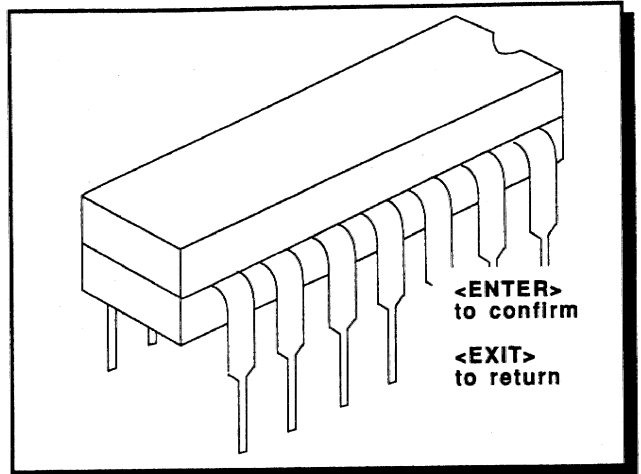

4. If another block has to be deleted, use the up and down arrow keys to scroll through the adjustment blocks and repeat the delete procedure as above. Otherwise, press **EXIT** to return to operational mode

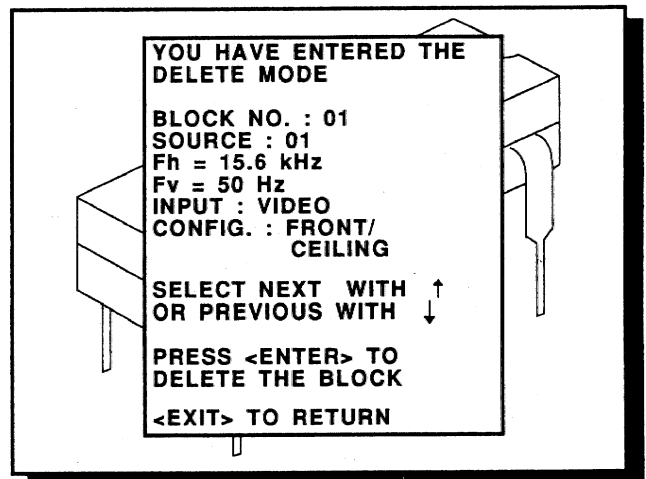

menu SE2

<ENTER> selected block will be deleted.
<EXIT> returns to the service mode menu, menu SE1.
<ADJUST> returns to operational mode.

SERVICE MODE

Deletion of all blocks

Highlights 'delete all blocks' with the arrow keys on the RCU800 and press **ENTER**.

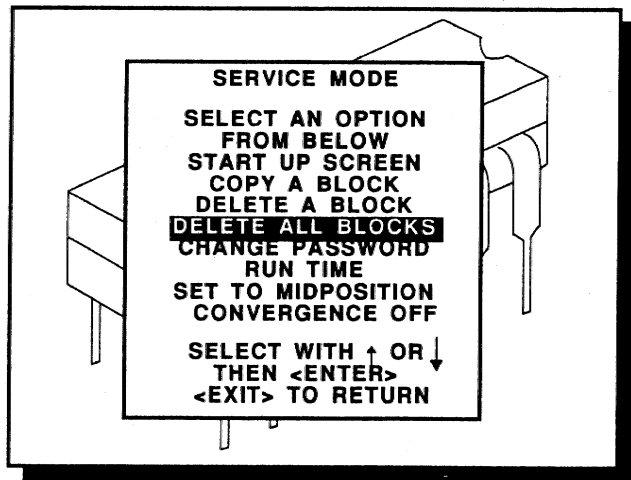

menu SE1

<ENTER> gives a confirmation message before deleting.
<EXIT> returns to the path selection menu, menu S1.
<ADJUST> returns to operational mode.

If you are sure to delete all blocks, press **ENTER** to confirm, otherwise press **EXIT** to return.

Once **ENTER** is pressed, all block headers and adjustment settings are definitely removed and cannot be restored.

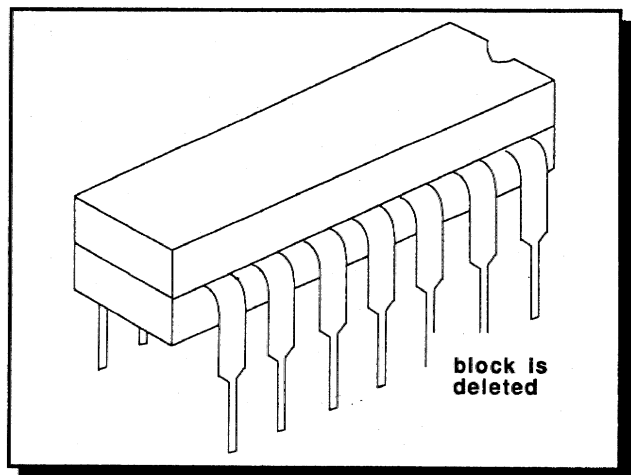
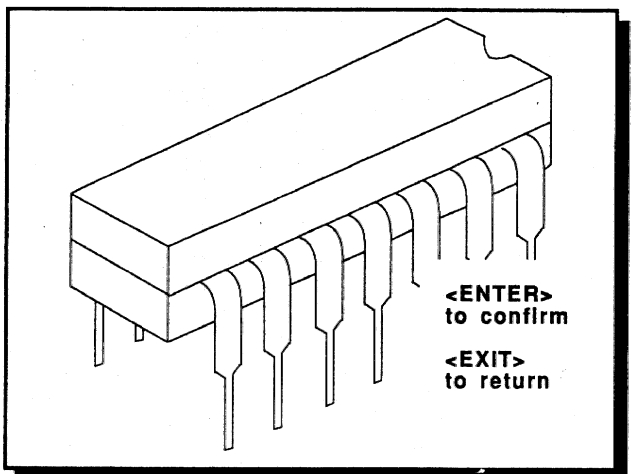

Change password

Highlights 'change password' with the arrow keys and press **ENTER**.

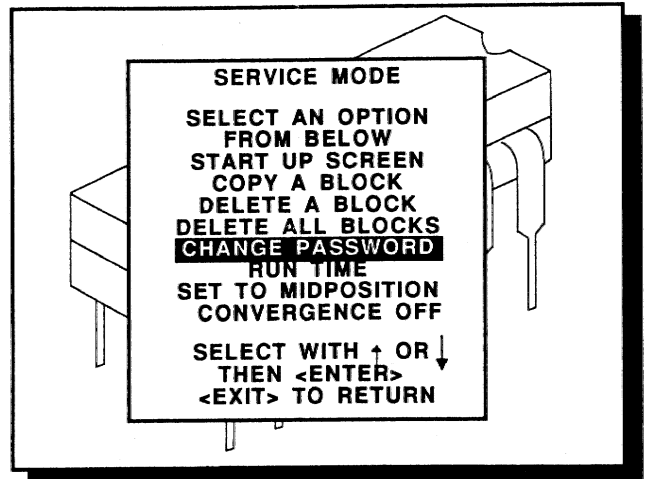

menu SE1

<ENTER> will display the selected item.
<EXIT> will returns to the path selection menu, menu S1.
<ADJUST> will returns to operational mode.

The correct password is displayed. The new password must consist of 4 digits between 0 and 9. Use the arrow keys on the RCU800 to select the digits to be changed. Use the numeric keys to enter the new digits.

Press **ENTER** to save the new password and to return to the service menu, menu SE1. Press **EXIT** to return to the Service menu without saving the new password.

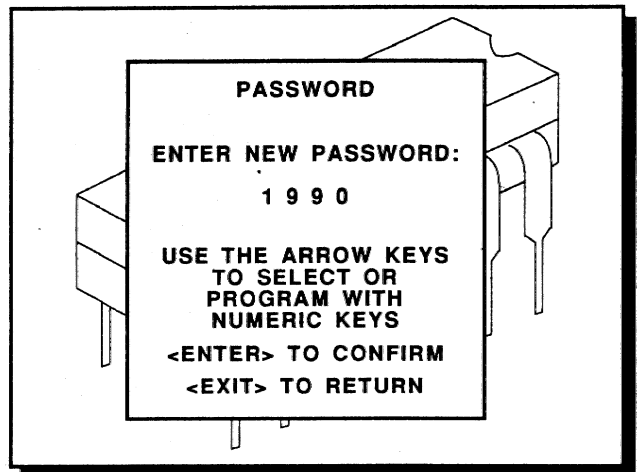

menu SE5

<ENTER> returns to service mode and saves the new password.
<EXIT> returns to service mode without saving the new password.

Run time

Highlights 'run time' with the arrow keys on the RCU800 and press ENTER to display the amount of time the projector is playing since its first start up at the factory.

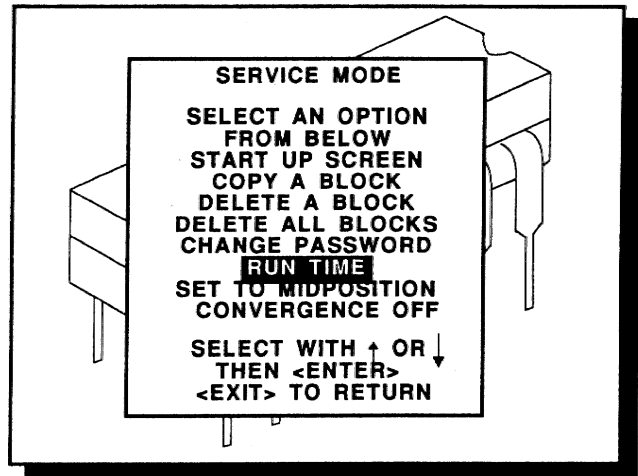

menu SE1

<ENTER> gives the selected item.
<EXIT> returns to the path selection menu, menu S1.
<ADJUST> returns to operational mode.

Note : all projectors leave the factory after a burn in periode of ± 100 hours.

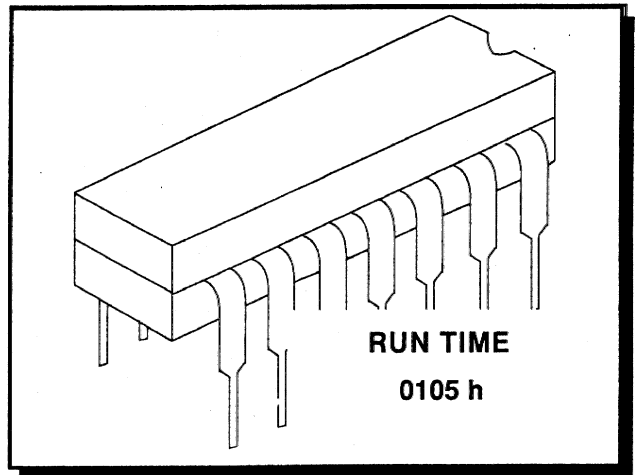

SERVICE MODE

Set to midposition

Highlights 'set to midposition' with the arrow keys and press **ENTER** to set all settings in their midposition.

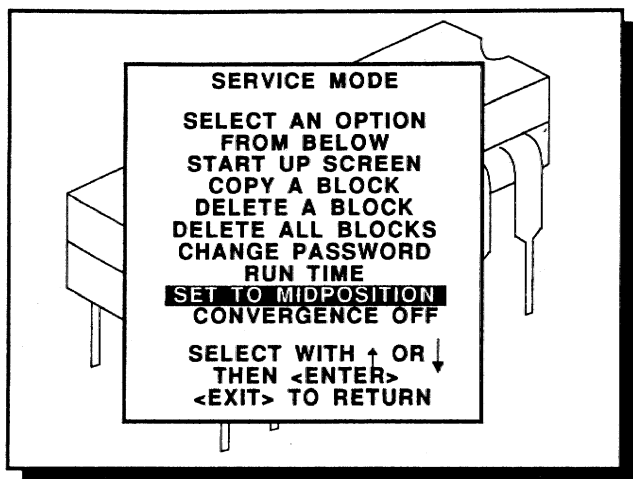

menu SE1

<ENTER> sets all settings in their midposition.
<EXIT> returns to the path selection menu, menu S1
<ADJUST> returns to operational mode.

Convergence off

Highlights 'convergence off' with the arrow keys and press **ENTER** to set all convergence settings in their midposition.

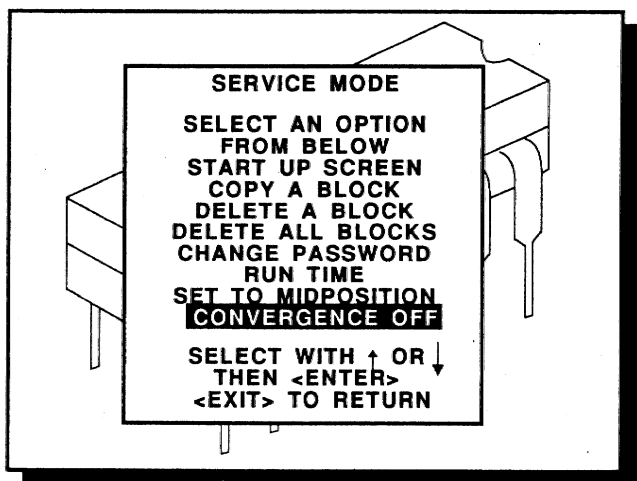

menu SE1

<ENTER> sets all convergence settings in their midposition.
<EXIT> returns to the path selection menu, menu S1
<ADJUST> returns to operational mode.

MESSAGES, WARNINGS AND FAILURES.

MESSAGES, WARNINGS AND FAILURES

SOURCE 01
Fh= 15.6 kHz
Fv= 050 Hz

When selecting a new source, information about this source will be displayed on the screen. Source number, horizontal and vertical frequency of the displayed source.

SOURCE 01

Announcement of the selected source.

enter
password
x x x x

Message to enter your password. Password contains 4 digits, which must be entered with the numeric keys of the RCU800.

text on

These messages will be displayed on the screen when pushing the TEXT key.

Text ON : the '*bar scale indication*' will be enabled during the change of an analog control in the '*operational mode*' + all warnings and failures will be displayed.

text off

Text OFF : the '*bar scale indication*' will be disabled during the change of an analog control in the '*operational mode*' + all warnings and failures will not be displayed.

PROJECTOR
ADDRESS :
003

Indication of the projector address when activating 'ADDRESS' on the RCU800 with pencil or other small object.

WARNING :
input not
available

Warning in combination with the RCVDS 800. This warning will be displayed when selecting an input slot of an RCVDS where the input board is missing.

WARNING :
source not
available

The input is a valid input but the source is not connected to the input terminals or the input source is switched off.

MESSAGES, WARNINGS AND FAILURES

WARNING :

**invalid
key entry**

When a wrong key is pressed on the RCU800.

WARNING :

**invalid
code entry**

Message when the entered password is wrong.

WARNING :

**end of ad-
just range**

End of adjustment range.

**WARNING :
input no
longer
available**

Message will be displayed when the input source is no longer available. Immediate hereafter appears the following message : *'check input signal or select new source'*.

**check in-
out signal
or select
new source**

Message will be displayed after the message *'input no longer available'*. It asks to check the connections between the source and the projector or to check if the source is switch on.

**WARNING :
input se-
lector not
available**

It warns you to check the power connection or the power status of the RCVDS800.
Next message will appear immediatly on the screen : *'go to stand-by'*.

WARNING :

**go to
stand by**

Projector will switch to *'stand-by'* when the RCVDS 800 is not longer available.

**WARNING :
invalid
frequency
input**

Entered frequency or frequency of source is out of the projector's range.

WARNING :
default
settings
loaded in
the E2PROM

Adjustment settings are lost. Reset via PC or MAC, or readjust image.

**table is
deleted**

Message to inform that selected table is deleted. This message will be followed by '*confirm message*', on which the user has to answer.

<ENTER>
to confirm
<EXIT>
to return

Confirm message for deleting tables. ENTER will delete the table. EXIT will return to the selected table.

FAILURE
invalid
RWI soft
version

Wrong software version in your projector. Call for technical support.

FAILURE
invalid
TAC soft
version

Wrong software version in your projector. Call for technical support.

FAILURE
I2C error
addr. : 7FH3

Hardware failure. Call a qualified service technician for repair.

FAILURE
short
circuit on
I2C bus

Hardware failure. Call a qualified service technician for repair.

FAILURE
RCVDS com-
munication
error

Serial communication error between RCVDS800 and projector.

**FAILURE
TAC commu-
nication
error**

Hardware failure. Call a qualified service technician.

**FAILURE
RWI commu-
nication
error**

Hardware failure. Call a qualified service technician.

**FAILURE
IRIS commu-
nication
error**

Communication error between IRIS 800 and the projector. Call a qualified service technician.

MESSAGES, WARNINGS AND FAILURES

OPTIONS

RCU800U

IR RECEIVER 800

REMOTE CABLE RCU800

CONTROL 800 SOFTWARE

RCVDS 800

IRIS 800

HDTV interface

ADAPTER AND COMMUNICATION CABLES

OPTIONS

RCU800U

Executive Remote Control.

Fixed address setting on 'zero address'. Every projector can be controlled with this RCU800U.
No access possible to the 'Adjustment Mode'.

Order number : 98 27440

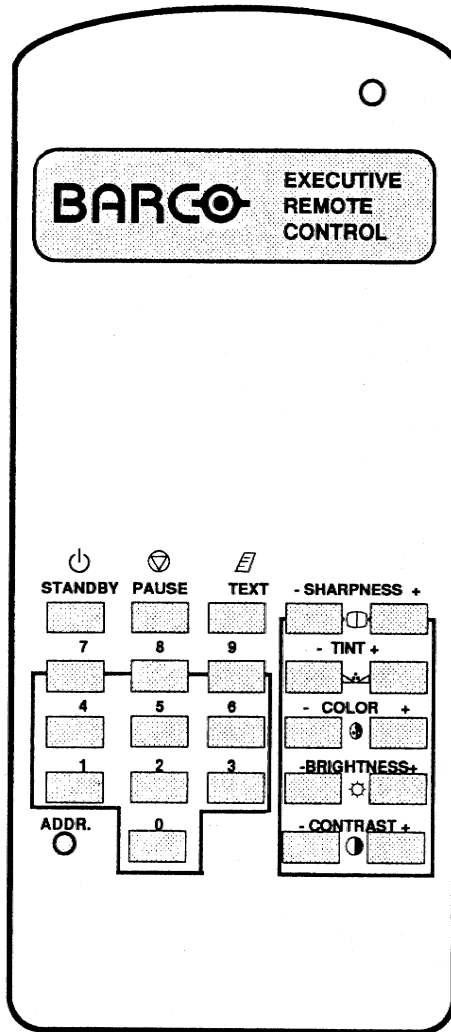

IR Receiver 800

This infra red receiver unit makes it possible to control the BARCOVISION 1600 from an other room.

There is a communication line with cable between the IR receiver and the projector or the RCVDS800. The control information from the RCU800 can now be sent to this IR receiver.

The IR receiver 800 displays the selected source on a 7-segment display.

Order number : 98 27510

IR REMOTE RECEIEVER 98 27510

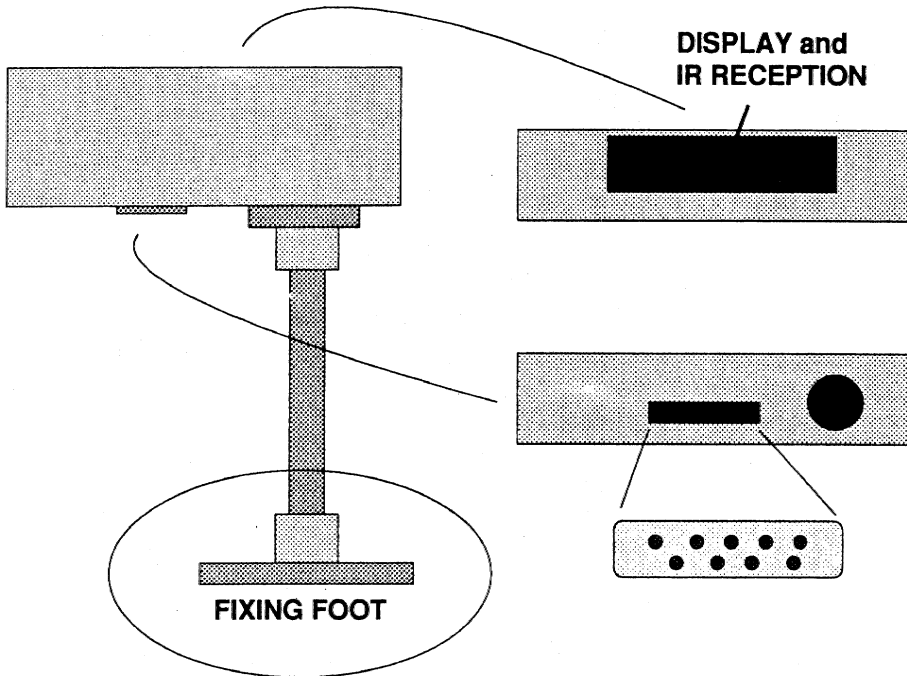

Hardwired RCU800 or RCU800U.

The control signals from the RCU800 or RCU800U can be sent to the projector via a wired connection.

Preparing your remote cable :

Use a shielded cable with a maximum length of 100 m and two mini-jack 2.5 mm connectors (order number : 31 3043).

- Peel back the vinyl covering of the cable on both sides and twist the wire core.

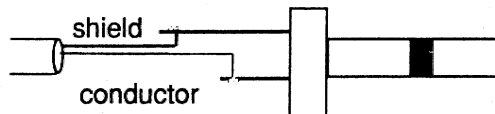

- Solder on both sides of the cable a jack plug as shown in drawing above.
shield = ground
conductor = data information

When the cable is ready, plug one side in the remote control and the other site in the connector on the front of the projector labelled 'remote'.

Control 800 software

The software is user friendly designed : mouse control, pull down menus, dialog boxes.

Two main applications are available with this software : remote control and transferring and receiving data of settings.

remote control simulation. Advantage : address range 0 to 255.

adjustment data : where can it be located when a IBM PC (or compatible) or MAC or Workstation is connected :

- hard memory device with files of settings.
- the contents of the local memory of the computer.
- the contents of the projector.

RCVDS 800

An optional RCVDS 800 source selector makes it possible to connect up to ten sources to the projector. To maximize the flexibility of the projector, an optional expansion module makes it possible to link ten source selectors in series, enabling the simultaneous connection of up to 90 sources to the projector.

IRIS 800

Easy-to-use, high precision automatic convergence system.

Using the IRIS 800's user-friendly onscreen displays, the unit effortlessly aligns the projected image on the screen faster and more accurately than ever before possible through the conventional 'manual' convergence process.

The flexible design of the IRIS 800 allows it to operate either in a table or ceiling mount installation.

HDTV / Tri-level sync interface

The HDTV/Tri-level sync interface converts an HDTV signal into a RGBS signal for an HDTV projector without any signal loss or image degradation.

- Possibility to convert an HDTV signal into an RGBS signal.
- Full compatibility with most advanced, improved, extended or HDTV-signals.
- Input signal can be in RGB or PrYPb format.
- Sync input can be Tri-level or standard sync.
- Separate sync or sync on G/Y is possible.
- Light weight, ruggedized design.
- Bandwidth : 20 MHz.
- Order number : 98 27430 (230V), 98 27439 (120V)

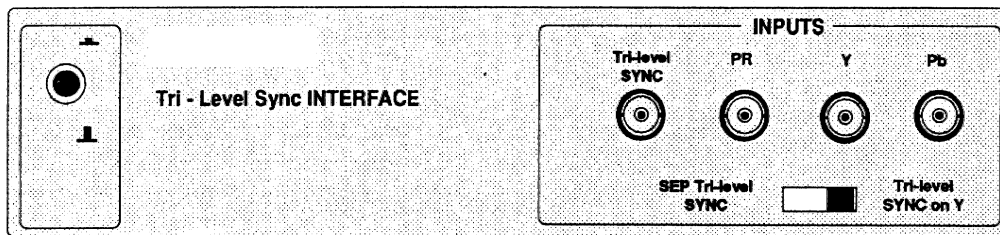

Adapter and communication cables

Barco provides several cables to connect peripheral equipment to the BARCOVISION 1600.

a. D9-D9 communication cable

- To connect a IBM PC (or compatible) to the projector.
- To connect a RCVDS 800 to the BARCOVISION 1600.
- To connect a IR receiver to the RCVDS800 or to the BARCOVISION 1600.
- To be used as extension cable for all other adapter cables.

Available length : 15 m, order number 98 27640; and 30 m, order number 98 27570

b. Din Mini8-D9 adapter cable.

- To connect a Macintosh computer to the BARCOVISION 1600.

Available length : 1 m, order number 98 27640.

c. D25-D9 adapter cable

- To connect a workstation to the BARCOVISION 1600.

Available length : 1 m, order number 98 27630

Order number for 30 m cable : 98 27570

APPENDIX A : BATTERY REPLACEMENT IN THE RCU

Battery replacement in the RCU800 or the RCU800U.

Remove the battery cover on the backside of the remote control by pushing it backwards.

Remove the battery from the compartment and disconnect the contact plate.

Connect a new 9V battery (type 6F22S or equivalent) to the contact plate.

Insert the battery back into the compartment and put the cover back.

Attention : when a new battery is installed, the projector address must be reprogrammed before using the RCU800. Nothing has to be done for the RCU800U.

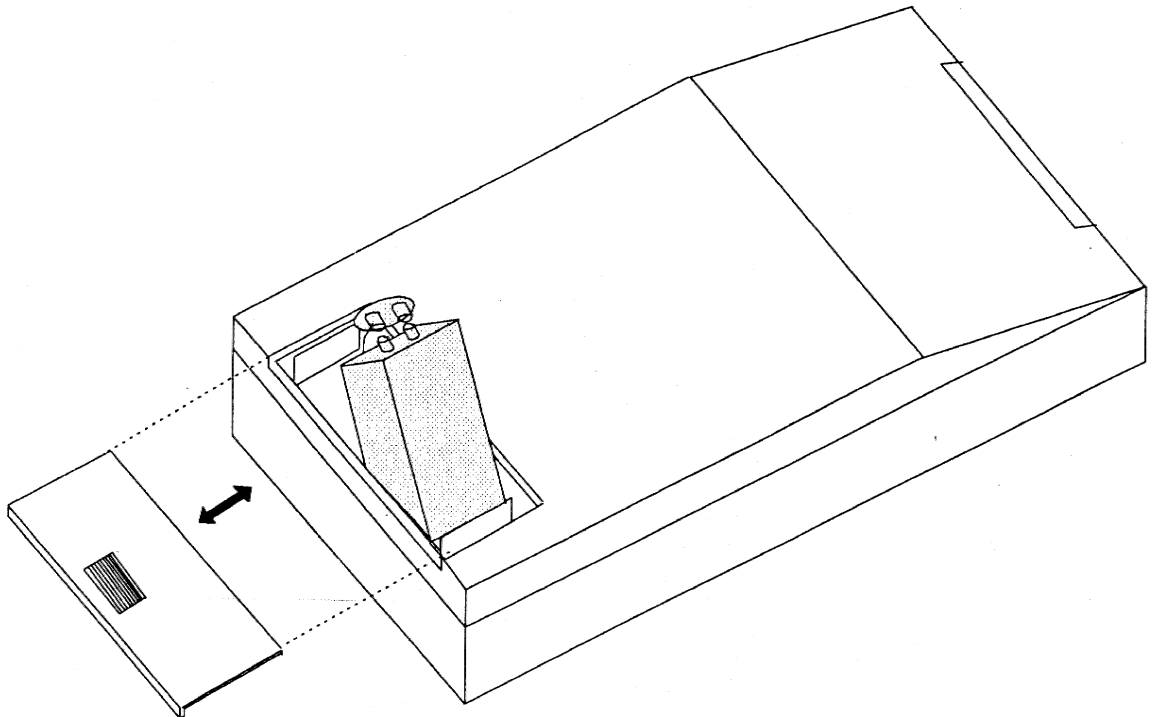

Adjustment Blocks

As the BARCOVISION 1600 is digitally controlled, all geometry and convergence adjustments are stored in the projector's memory as numeric values. These numeric values are used to control digital potentiometers which in turn, control the projector. Each source connected to the projector has a unique set of adjustment data which is automatically downloaded into the projector's digital potentiometers as the source is selected. This set of adjustment data is referred to as an "adjustment block".

An adjustment table is automatically created for a source when the source is first connected to the projector and the adjust mode is entered. If other sources have already been connected to the projector and geometry and convergence adjustments have been performed on these sources, the projector will use Linear Digital Interpolation to create a new block for the new source. This block will provide an initial set of adjustments for the new source that have been calculated by the projector from "previous experience".

The projector's memory has the capacity to store 38 adjustment blocks. The adjustment block consists of two parts, the block header and the data representing the convergence and geometry adjustments of the source the block corresponds to. The block header contains the basic characteristics of the source and the projector configuration used to display the source.

<i>Block Header</i>	<i>example of block header</i>
Block number	01
Source number	01
Horizontal frequency	15.6 kHz
Vertical frequency	50 Hz
Input type	video
Scan inversion switch configuration	front/ceiling

The data representing the geometry and convergence adjustments for the source follows the block header.

I. Video

Input : 2 x BNC connectors (looped through)
75 ohm termination switch
500 mVpp to 2 Vpp ± 3 dB

II. Super Video

Input : 2 x 4 pins mini DIN connector (looped through)
Pin configuration DIN connector :
pin 1 : ground (earth) luma signal
pin 2 : ground (earth) chroma signal
pin 3 : luma (Y) signal 1 Vpp ± 3 dB
pin 4 : chroma (C) signal 300 mVpp ± 3 dB
75 ohm termination switch on rear panel.

III. RGB analog circuit

RGsB : for sync on Green or
RGSB : for separate sync, Hor and Vert sync or composite sync.

Input : 5 BNC connectors
Red : 0.7 Vpp ± 3 dB
Blue : 0.7 Vpp ± 3 dB
Green : 0.7 Vpp ± 3 dB
1 Vpp ± 3 dB if sync on green
Vert sync : 1 Vpp ± 3 dB or 4 Vpp ± 3 dB
Hor sync / comp. sync : 1 Vpp ± 3 dB or 4 Vpp ± 3 dB

IV. Deflection circuits

Vertical deflection

Frequency : from 37 Hz to 140 Hz

Retrace time : < 450 μ s

Horizontal deflection

Frequency : 15 kHz and 30 to 35 kHz

Retrace time : < 4.7 μ s

V. High voltage

Stabilized EHT : 34.7 kV

VI. Power requirements

- 220 V ac to 240 V ac or 110 V ac internal switchable
- frequency independence between 40-100 Hz
- Electrical ratings : 230V - 2.5A , 120V - 5A

VII. Display

Projection tubes : - 9" high resolution projection tubes, electrical focus.
- liquid coupled system
- Red, Blue and Green CRT's

Lenses : 90 00670/90 00679 : TOC7, high resolution F1.07 Optical coupled Hybrid lenses.
90 00671/90 00678 : HD300, high resolution fully color corrected F1.15 Optical coupled Hybrid lenses

Convergence : calibration using 13 independent zones.

Optical resolution : TOC7 : 5 lp/mm, HD300 : 10 lp/mm (option : HD120, HD180 : 12 lp/mm)

VIII. Light output

At 10% peak white : 1620 lumen

IX. RGB Bandwidth

50 MHz \pm 3dB

X. Mechanical characteristics

Dimensions : see next page.

XI. Mounting

Table or ceiling; front or rear projection possibility.

Adaptation ceiling-table : incorporated switches

Adaptation front-rear : incorporated switches

XII. Safety

IEC950

XIII. Environment

The projector is designed to be used within the following operating range.

Max. operating range
Temperature : 0° - 40°C
Humidity : 0 - 90% non condensing
Altitude : 0 - 3000 m (0 - 10000 ft)

Storage
Temperature : - 30° to 65°C

XIV. Weight

Net weight : 80 kg (176 lbs)

APPENDIX D : SPECIFICATIONS

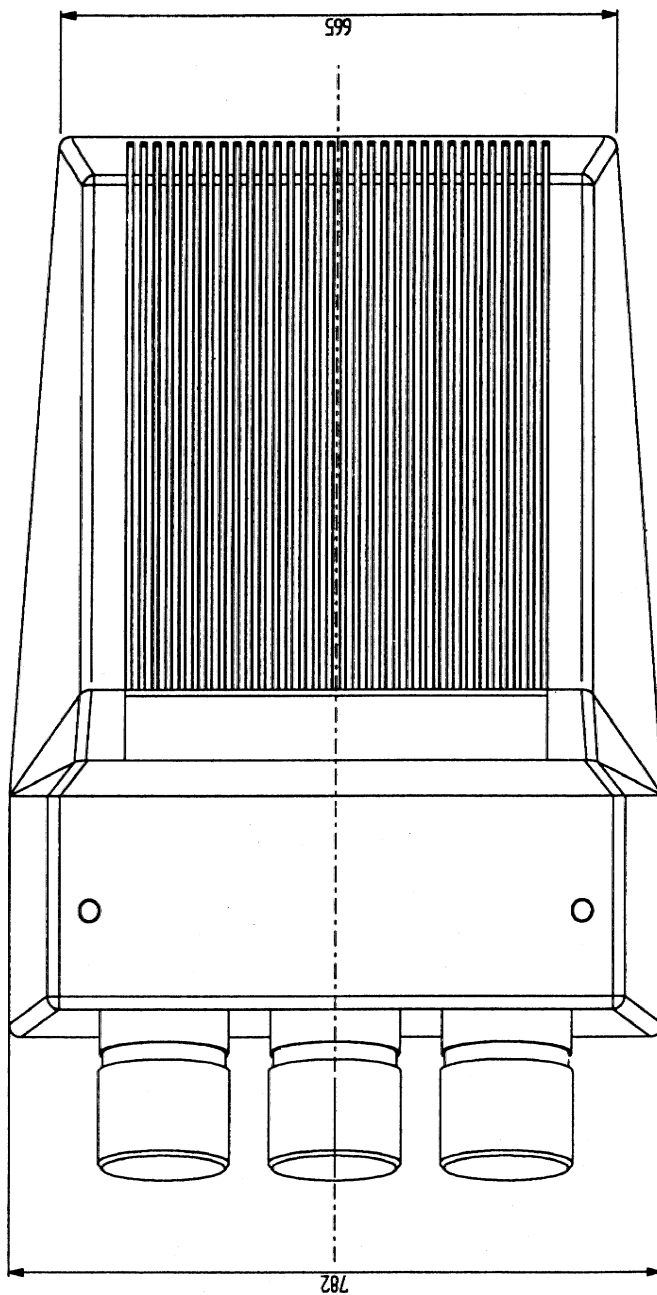
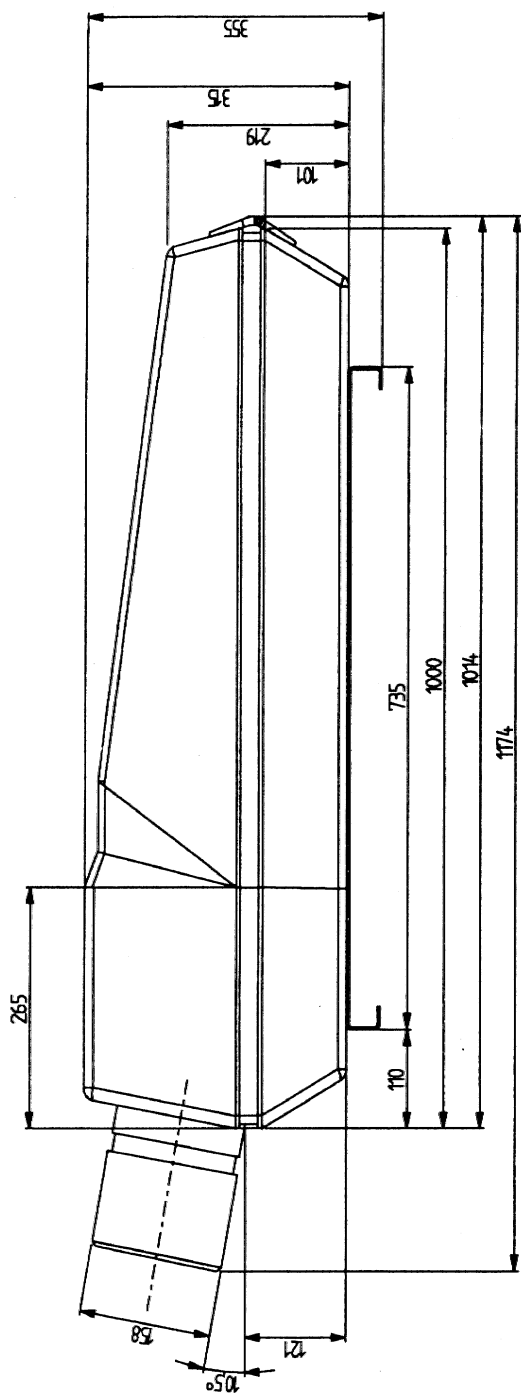

MATERIAL SAFETY DATA SHEET

Form Approved Bureau Budget No. 45-R0338
 MANUFACTURER'S NAME AND FSCM (Federal Supply Code for Manufacturer's) BARCO n.v. EMERGENCY PHONE NO. 32-56-368211
 ADDRESS (Number, Street, City, State, and ZIP Code) Noordlaan 5 B- 8720 KULURNE

CHEMICAL NAME AND SYNONYMS Ethylenglycol & glycerol
 TRADE NAME AND SYNONYMS Cooling liquid 512334
 CHEMICAL FAMILY Polyalcohols
 FORMULA $C_2H_6O_2 + C_3H_8O_3$
 FEDERAL STOCK NUMBER (FSN) GROSS WEIGHT (LBS) OUTSIDE PACKAGE DIMENSIONS

MIL-STD-1311/NATIONAL FIRE PROTECTION ASSOCIATION STD 704M SIGNAL HEALTH..... SPECIFIC HAZARD.....
 FLAMMABILITY..... REACTIVITY..... TRESHOLD LIMIT VALUE (Units).....

PAINTS, PRESERVATIVES, AND SOLVENTS % TRESHOLD LIMIT VALUE (Units) %
 PIGMENTS % TRESHOLD LIMIT VALUE (Units) %
 CATALYST % TRESHOLD LIMIT VALUE (Units) %
 VEHICLE % TRESHOLD LIMIT VALUE (Units) %
 SOLVENTS % TRESHOLD LIMIT VALUE (Units) %
 ADDITIVES % TRESHOLD LIMIT VALUE (Units) %
 OTHERS % TRESHOLD LIMIT VALUE (Units) %

HAZARDOUS MIXTURES OF OTHER LIQUIDS, SOLIDS, OR GASES % TRESHOLD LIMIT VALUE (Units)

SECTION I	SECTION II - HAZARDOUS INGREDIENTS	SECTION III - PHYSICAL DATA	SECTION IV - FIRE AND EXPLOSION HAZARD DATA
BOILING POINTS (°C.)	201°C	SPECIFIC GRAVITY (H ₂ O = 1)	1.15
VAPOR PRESSURE (mm Hg.)	3 mm Hg	PERCENT VOLATILE BY VOLUME (%)	—
VAPOR DENSITY (AIR = 1)	2.2	EVAPORATION RATE (..... = 1)	—
SOLUBILITY IN WATER	∞	APPEARANCE AND ODOR	
FLASH POINT (Method used)		FLAMMABLE LIMITS	LOWER EXPLOSIVE LIMIT UPPER EXPLOSIVE LIMIT
EXTINGUISHING MEDIA		SPECIAL FIRE FIGHTING PROCEDURES	
UNUSUAL FIRE AND EXPLOSION HAZARDS			

SECTION V
 TRESHOLD LIMIT VALUE 100ppm
 EFFECTS OF OVEREXPOSURE
 EMERGENCY AND FIRST AID PROCEDURES

SECTION VI
 REACTIVITY DATA
 STABILITY
 UNSTABLE
 STABLE X
 INCOMPATIBILITY (Materials to avoid)
 HAZARDOUS DECOMPOSITION PRODUCTS
 HAZARDOUS POLYMERIZATION
 MAY OCCUR X
 WILL NOT OCCUR
 STEPS TO BE TAKEN IN CASE MATERIAL IS RELEASED OR SPILLED
 Rinse with water

SECTION VII
 SPILL OR LEAK PROCEDURES
 WASTE DISPOSAL METHOD

SECTION VIII - SPECIAL PROTECTION INFORMATION
 RESPIRATORY PROTECTION (Specific type)
 VENTILATION LOCAL EXHAUST SPECIAL
 MECHANICAL (General) OTHER
 PROTECTIVE GLOVES EYE PROTECTION
 OTHER PROTECTIVE EQUIPMENT

SECTION IX
 SPECIAL PRECAUTIONS
 PRECAUTIONS TO BE TAKEN IN HANDLING AND STORING Harmful if swallowed
 Keep out of the reach of children
 OTHER PRECAUTIONS To avoid from outdoors

THE INFORMATION CONTAINED HEREIN IS BASED ON DATA CONSIDERED RELIABLE BY THE ACCURACY OF THE RESULTS OBTAINED FROM THE USE THEREOF. VENDOR ASSUMES NO RESPONSIBILITY FOR INJURY TO VENUEE OR THE MATERIAL CAUSED BY THE MATERIAL IF REASONABLE SAFETY PROCEDURES WERE FOLLOWED. THE DATA SHEET ADDITIONALLY, VENDOR ASSUMES NO RESPONSIBILITY FOR INJURY TO VENUEE OR THIRD PERSONS FROM THE USE OF THE MATERIAL IF REASONABLE SAFETY PROCEDURES WERE FOLLOWED. FURTHERMORE, VENUEE ASSUMES THE RISK IN HIS USE OF THE

