

BARCO-FULLHD

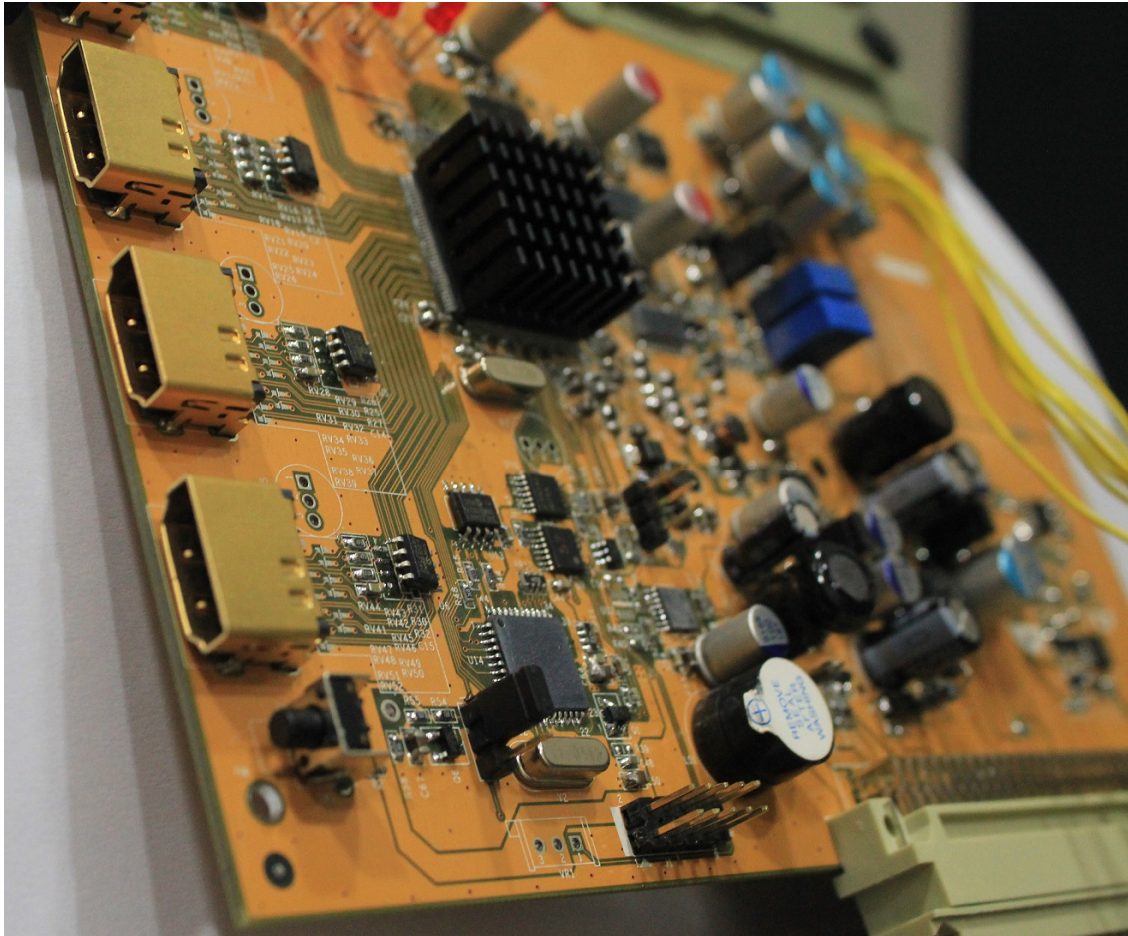

(Plastic bracket is not included)

◆ BARCO-FULLHD brief

BARCO-FULLHD is a newly card for BARCO 808, 1208, 1209, Cine 8, Cine 9, Cinemax CRT projector. It has four HDMI input port with **True 12bit** deep color support, and using three high precision 14bit video DACs convert to high precision analog RGB video signal. Build-in **advanced Gamma** circuit create real nature image for your BARCO projector. Gain control can adjust pure white of the image. The BARCO-FULLHD is an ideal HDMI card for BARCO CRT projector to connect feature digital HD source, such as SONY PS3/4, Blue-ray Disc, and HDTV/Media Set top-box.

◆ FEATURES

■ HDMI input path

- HDMI 1.0, 1.1, 1.2, 1.3, 1.4, HDCP 1.1, 1.2, and DVI 1.0 compliant
- DTV mode support (480P, 576P, 720P, 1080i, 1080P) up to 75Hz
- PC mode support VGA, SVGA, XGA, SXGA, UXGA .etc
- Support 4:4:4 RGB / YCbCr input
- Support 4:2:2 YCbCr input
- Support both 16-235 and 0-255 color range
- 14bit Data processing with High precision **250MHz 14bit** DAC
- Improved advanced gamma correction processing and white level adjust
- High speed and ultra 1.65GHz bandwidth output Buffer
- Support deep color mode for 10bit and 12bit
- Support 100/120Hz for 720P and 1080i

■ Board

- Fully compatible with BARCO series projector's BARCO port3 input slot
- IR control input selection and gamma level adjust
- Ultra Low ESR capacitor to filter noise, and lead to cleanest image
- ESD improved to prevent Electrostatic Discharge damage while plug HDMI cable

BARCO-FULLHD Features

Features	Description
Gamma	Advanced Opamp
Sharpness	Advanced Opamp
Picture purity	Advanced Opamp and new analog power supply design
Range expand	Support
Stability	ESD enhanced
BBF (black boost function)	Support
Manual select input color space by remote	Support
H V Sync Polarity adjust	Yes
3D sync output	Support

■ HDMI support mode table

PC mode	640X480	60HZ 72HZ 75HZ 85HZ
	800X600	56HZ 60HZ 72HZ 75HZ 85HZ
	1024X768	43HZ 60HZ 70HZ 75HZ 85HZ
	1152X864	60HZ 70HZ 75HZ 85HZ
	1366X768	60HZ 70HZ 75HZ
	1280X1024	43HZ 60HZ 75HZ 85HZ
	1600X1200	48HZ 60HZ 70HZ 72HZ 75HZ
	1920X1200	60Hz 70Hz 75Hz
	1440X960	43HZ 60HZ 72HZ
HDTV mode	480P	60HZ
	576P	50HZ
	720P	50HZ 59HZ 60Hz 100Hz 120Hz
	1080I	29HZ 30HZ 50HZ 59HZ 60HZ 96HZ ^{*1} 100Hz 120Hz
	1080P	50HZ 59HZ 60Hz 70HZ 72HZ 75HZ 24HZ ^{*2} 25HZ ^{*2} 29.9HZ ^{*2} 30HZ ^{*2}

【Notice】

*1 need use powerstrip to set graphic card output this mode

*2 BARCO-FULLHD support these modes, and will output these signal with same refresh rate as same as input source, but most CRT projector are only support 30Hz-150Hz, using such low refresh rate may let projector working with incorrect behavior.

PRELIMINARY, SUBJECT TO CHANGE WITHOUT NOTICE

◆ BARCO-FHD Board overview

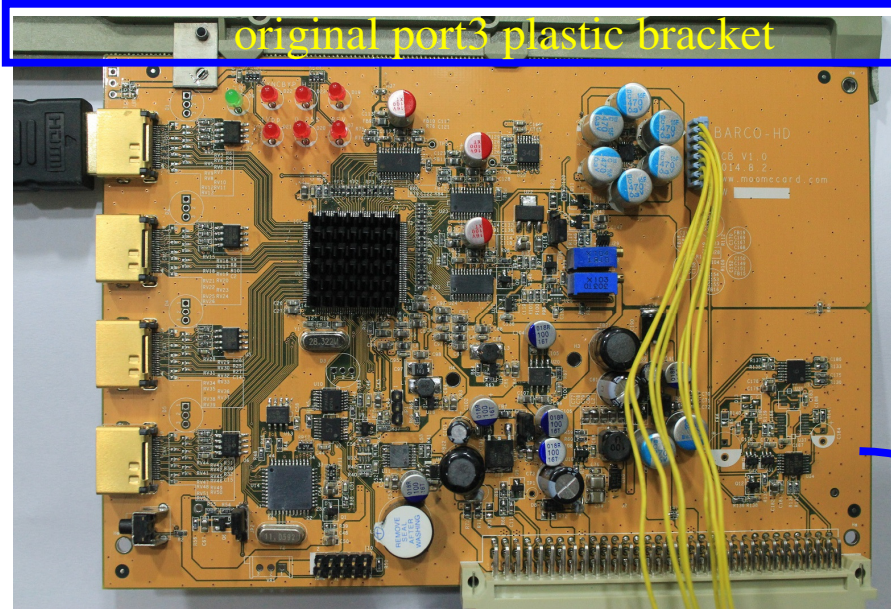

Replace original port3 interface card with BARCO-FHD

Note: how to take off plastic bracket, please refer the installation note

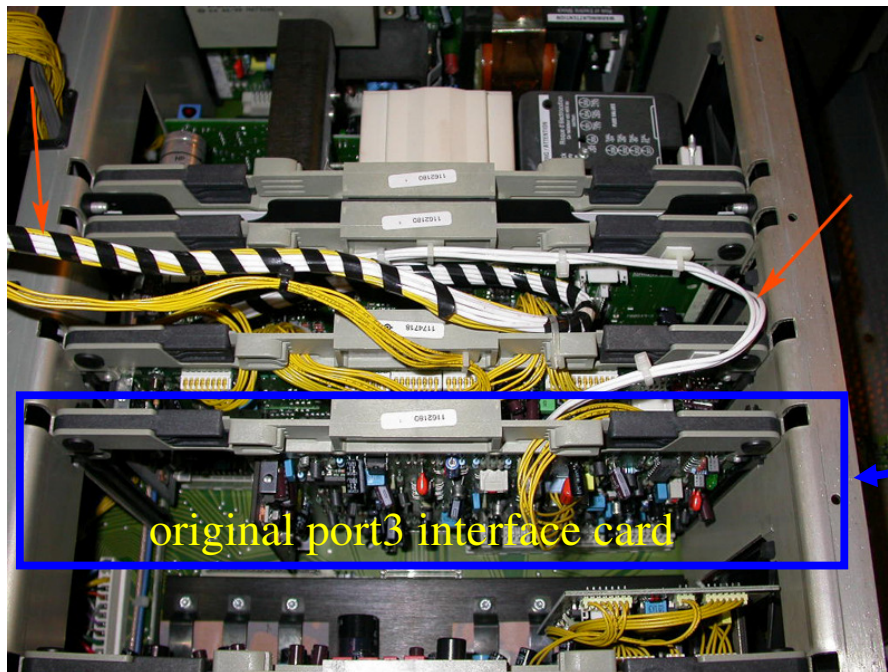

◆ Port3 control kit Board overview

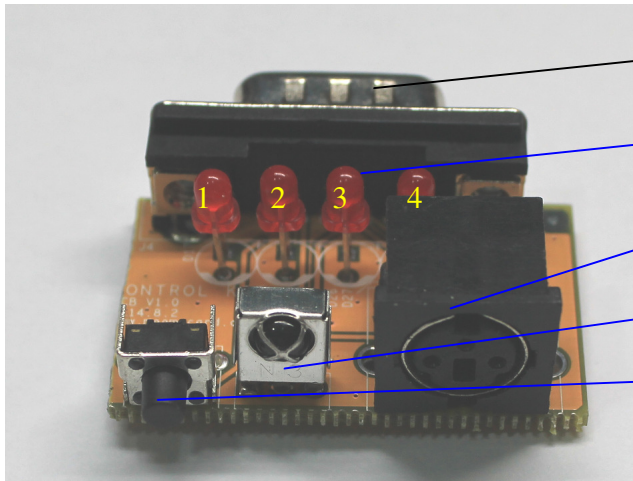

- Port 3 connection
- LED indication for selected port
- 3D sync output port
- IR receiver for BARCO-FHD
- Input port selection switch

Connect control kit to Port3 to control BARCO-HD card

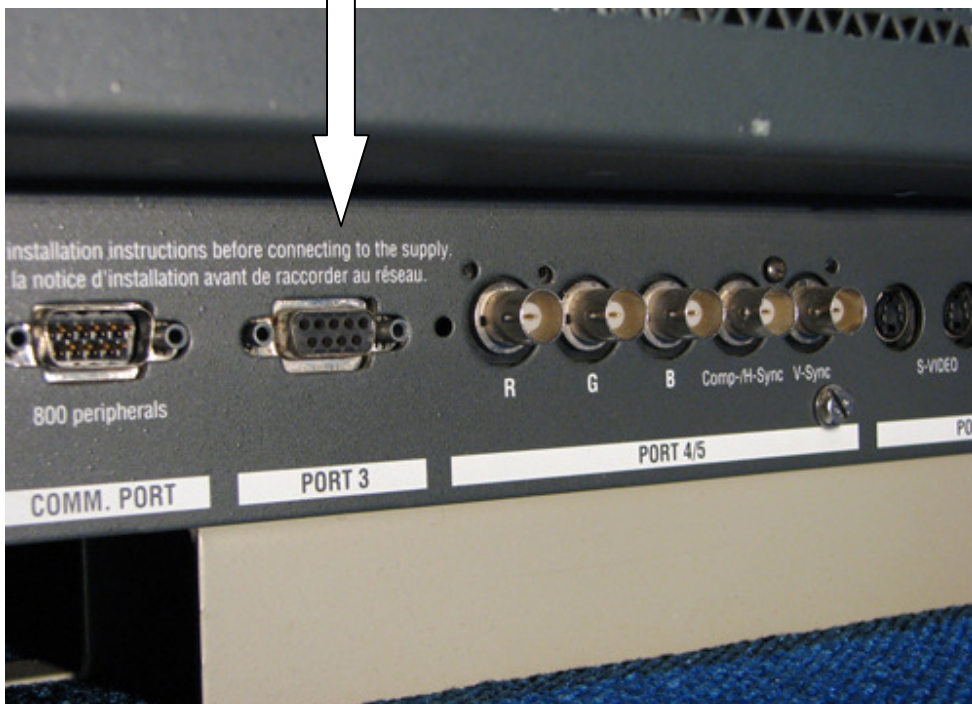

PRELIMINARY, SUBJECT TO CHANGE WITHOUT NOTICE

3D Sync output port:

3D Stereo sync output for 3D glasses emitter

IR:

IR control can let you switch between input sources and adjust gamma level

SW:

Manual select input1 ~ input4

Input LED:

When input port is selected, the correspond LED will light up

LED indication:

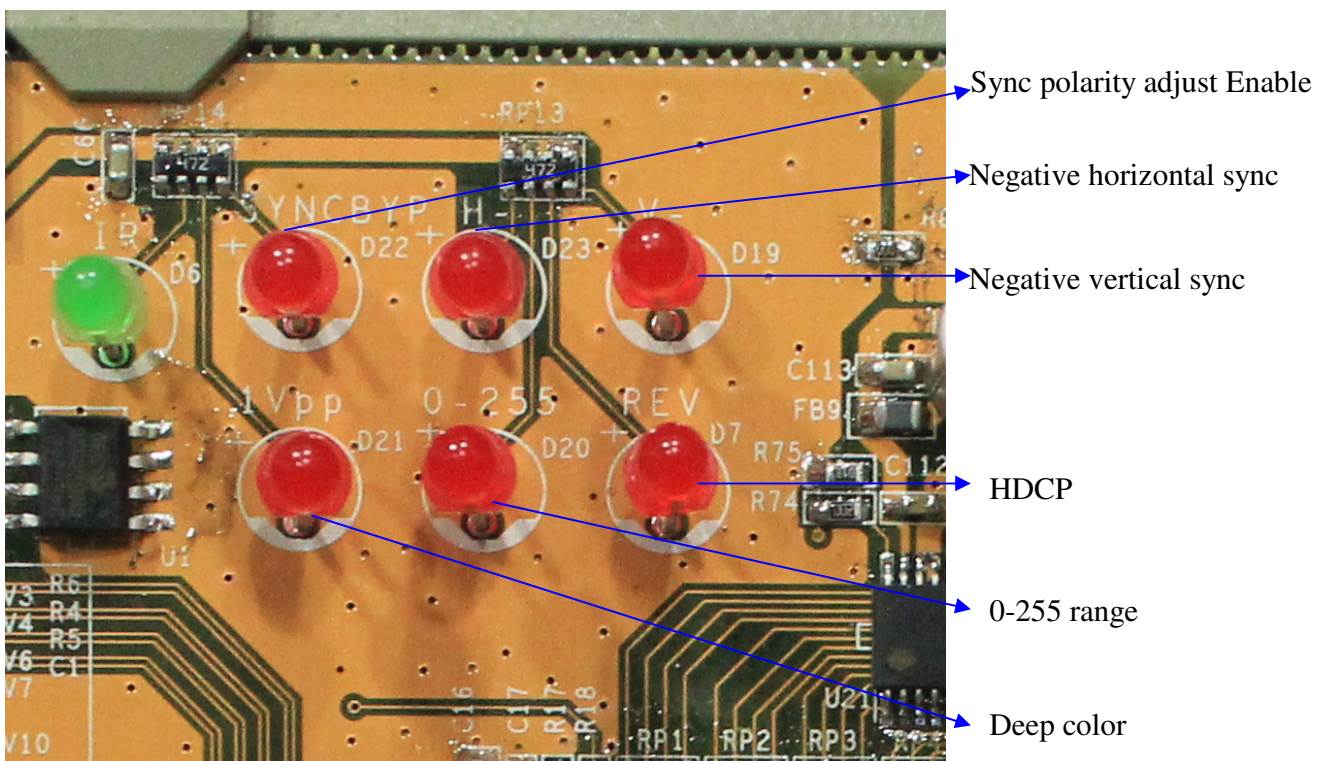

High bandwidth video amp & solid capacitor use:

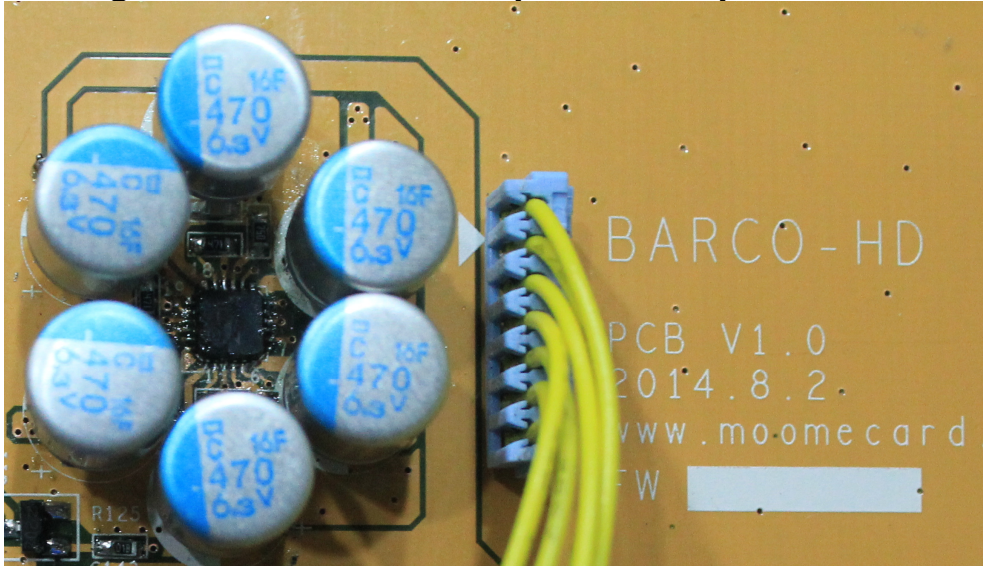

14Bit Video DAC use:

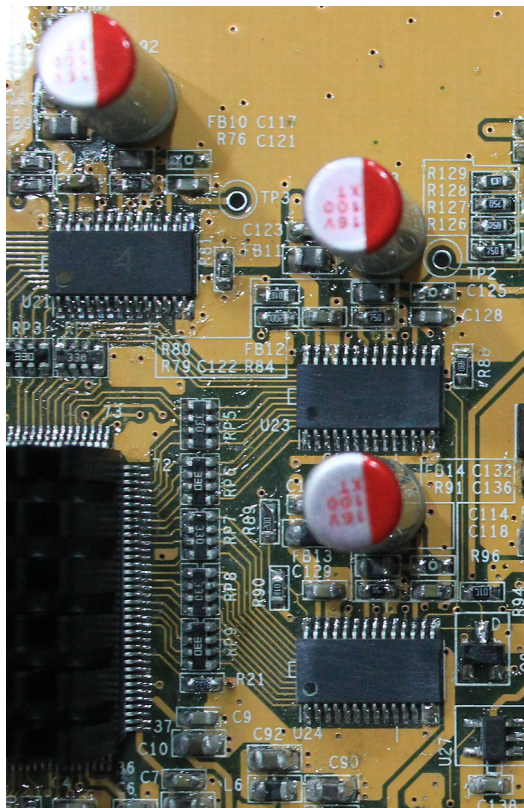

IR Valid Key List:

Key name	function	note
1	Select input HDMI0	
2	Select input HDMI1	
3	Select input HDMI2	
4	Select input HDMI3	
5	Auto Detect Input Color Space	
6	Set Input Color Space at YCbCr 422	
7	Set Input Color Space at YcbCr 444	
8	Set Input Color Space at RGB 444	
gamma	gamma up/down	Total 20 step
0	Select minima gamma	For test only
100	Select maxima gamma	For test only
A	Output range 16-235	(range expand off)
B	Output range 0-255	(range expand on)
C	Output range 16-235 with BBF	Black Boost Function
MUTE	Video Mute	
MODE	3D glasses sync signal on/off	
9	3D sync delay on/off	Enable 3D glasses sync delay to prevent ghost (adjust delay by VR on the panel)
RETURN	3D sync polarity adjust	Adjust 3D glasses sync polarity
D	Output sync process on/off	When yellow LED on, you can use display key to adjust output sync polarity
Display	output sync polarity adjust	

【Notice】 With range expand function on, you will not see BTB and WTW. But you can get more black and white picture.

◆ **BARCO-FULLHD V3 Spec:**

Weight: 250g

Dimension: 180mmX120mmX36mm

Power consumption: 5W (1080P 60Hz)

Maxima resolution: 1920X1200 75Hz

Analog bandwidth: 1650MHz

Output white level: 0.6V-1.0V adjustable

◆ **Technical support:**

moome@seed.net.tw

◆ **Warranty:**

One year